

ALL ARMS SEARCH COURSE

Learning Plan

United Nations Mine Action Service

ALL ARMS SEARCH - COURSE



Acronyms

Section One: General

Section Two: Course Management Details

Section Three: Learning Outcome Specifications

Section Four: Course Module Specifications

Annexe A: Course Block Syllabus

Annexe B: Course Evaluation Templates

Annexe C: Participant Assessment Template

Annexe D: Search Document Report Template

Annexe E: Glossary of Terms and Concepts

ACRONYMS

5Cs	Confirm, Clear, Cordon, Control and Call
AAR	After Action Review
AASC	All Arms Search Course
ADF	Amani Defence Force
ADFPM	Amani Defense Forces Protected Mobility
AJP	Allied Joint Publication
ALF	Amani Liberation Front
AMISOM	Africa Union Mission in Somalia
ANFO	Ammonium Nitrate and Fuel Oil
AO	Area of Operations
AO	Area of Operation
AU	Africa Union
AXO	Abandoned Explosive Ordnance
BG	Battle Group
BME	Bomb Making Equipment
BPST-A	British Peace Support Team - Africa
CAGE	Channeling, Aiming Markers, Ground, Environment
CIED	Counter-Improvised Explosive Devices
CMD	Conventional Munition Disposal
CRSV	Conflict-Related Sexual Violence

CW	Command Wire
DFC	Directional Fragmentation Charge
ECM	Electronic Counter-Measures
EFPs	Explosive Formed Projectiles
EO	Explosive Ordnance
EOD	Explosive Ordnance Disposal
ERW	Explosive Remnants of War
FOB	Forward Operating Base
GSA	Ground Sign Awareness
HHMD	Hand Held Metal Detector
HME	Home-made Explosive
I/NGOs	International/Non-Governmental Organizations
ICP	Incidence Command Point
IED	Improvised Explosive Device
IED TM	IED Threat Mitigation
IEDD	Improvised Explosive Device Disposal
LP	Learning Plan
LSA	Land Service Ammunition
MD	Metal Detector
MTT	Mobile Training Teams
MOA	Method of Attack
NATO	North Atlantic Treaty Organization

NCO	Non-Commissioned Officers	VB	Vehicle borne
NGO	Non-Governmental Organization		
NIS	National Intelligence Service	VO	Victim Operated
PB	Patrol Base	VOIED	Victim Operated Improvised Explosive Device
PCCs	Police Contributing Countries		
PSO	Peace Support Operations		
PSRD	Peace and Security Research Department		
Q&A	Questions and Answers		
RC	Remote/Radio Control		
ROC	Rehearsal of Concept		
RPG	Rocket Propelled Grenade		
SBE	Syndicate Based Exercise		
SEA	Sexual Exploitation and Abuse		
SMEs	Subject Matter Experts		
TCCs	Troop Contributing Countries		
TM	Threat Mitigation		
TTPs	Tactics, Techniques, and Procedures		
UAV	Unmanned Aerial Vehicle		
UN	United Nations		
UNCmd	United Nations Command		
UNMAS	United Nation Mine Action Service		
UXO	Unexploded Ordnance		
VA/VP	Vulnerable Areas/ Vulnerable Point		

SECTION ONE – GENERAL

1. **Introduction.** Explosive hazards (ERWs, Landmines and IEDs) are security realities that mission personnel, humanitarian workers and the civilian population have to deal with on a day-to-day basis. This is because, even after the war has ended, explosive hazards that have been left behind can stay on the land for years hence impacting the livelihoods of people since they cannot till their lands or go about with their normal business.

2. Further to this, explosive hazards have continued to cause devastating impacts to mission environments, therefore, affecting communities in their recovery and reconstruction efforts. It is in this regard that the All-Arms Search Course was created to build capacity for troops and police earmarked for deployment and those already deployed. The course will do this by enhancing the knowledge and skills of TCCs and PCCs on basic search capabilities required in mission environments.

3. **Course Design.** This Learning Plan (LP) is intended to act as a guide to the respective training and education delivery institution. While the information contained within this LP is descriptive and intended to provide a degree of flexibility in delivery, any deviation from the course logic (particularly the Module Specifications) should be properly recorded and the LP updated accordingly.

4. **Scope.** This course is generic. Exercises and scenarios have been built into the course programme to provide a realistic learning experience. A gendered approach to training will be adopted throughout the course and a glossary of terms

(including gender-related concepts) are contained in Annex D for quick reference.

5. **Training Need.** The extant security threats have continuously compromised the successful operation in peace missions. Search is a capability that can be used across all operating environments by assisting TCCs and PCCs in locating specific targets by the use of intelligence assessment, systematic procedures and appropriate detection techniques.

6. **Course Aim.** To enhance the knowledge and skills for effective search procedures, to increase operational effectiveness in an IED threat environment.

7. **Target Audience.** This is an all arms course for Troops Contributing Countries (TCCs) and Police Contributing Countries (PCCs). Participants selected will be men and women earmarked for deployment or likely to be deployed for UN/AU missions:

- a. Military
 - (1) Search Advisors / Coordinators – Lt to Captain or Senior NCO
 - (2) Team Commanders – Corporal
 - (3) Scribes – Lance Corporal
 - (4) Searchers – Private/Sapper to Lance Corporal
- b. Police
 - (1) Search Advisors / Coordinators – Senior Sergeant to Inspector
 - (2) Team Commanders – Sergeant

- (3) Scribes – Corporal
- (4) Searchers – Constable

c. AU/UN Agencies

8. **Learning Outcomes:** The course has three learning outcomes as follows:

- a. **Learning Outcome # 1 – Understanding the operating environment.** Enhance the participants' knowledge of the conventional operating environment, how it is impacted by explosive hazards and develop skills to mitigate the IED threat.
- b. **Learning Outcome # 2 – Search Operations.** Develop practical skills to conduct the full spectrum of intermediate search capability.
- c. **Learning Outcome # 3 - Practical Exercises and Tests.** Apply lessons learnt to demonstrate a sufficiently high standard to deploy on operations in an IED threat environment.

9. **Course Methodology and Strategy:** This course will be conducted in 15 training days. The course is designed to be skill-driven. The lecture portion of the course will be delivered in standard “lecture” format. Lectures will be reinforced through syndicate work (Problem Based Learning) building skills in IEDs.

10. **Course Conduct and Block Syllabus:** Each of the 15 training days will contain 9 or 8 x 45 periods. A block syllabus has been attached to this Learning Plan to serve as a guide to the layout and structure of the various lessons. This block syllabus may be amended to suit specific requirements but the specifications for each of the Modules (Section 4) must be

followed. Deviation from these specifications must be coordinated with the Research Department. **See Annex A for the Course Block Syllabus**

SECTION TWO – COURSE MANAGEMENT DETAILS

11. **Initiation and Staffing Process.** The Course Director should call a coordination meeting with key administrative personnel approximately 10 weeks before the commencement of the course to confirm the course requirements and begin confirming the availability of staff. This meeting will be held in conjunction with the EOD/IEDD School/Training Facility where a draft schedule will be discussed and agreed upon. From this point, the procedures of the respective training and education delivery institution will be followed. During this process, there will be close coordination between the EOD/IEDD School/Training Facility HQ, School to ensure a cohesive vision of the schedule and applicable resources (to include facilitators, subject matter experts, and training aids).

12. **Directing Staff/Facilitator Details.** A team of Directing Staff (DS) will coordinate the conduct of the activities throughout the course. This team will be primarily responsible for the coordination and administration of the course. Subject Matter Experts (SME) may be required as facilitators for the course and one of these SME's is to be designated as the "Lead Facilitator" for the duration of the course. The Lead Facilitator will be the point of contact between the facilitation staff and the administrative support. There may be exceptional circumstances where the Course Director may act as the Lead Facilitator. The composition of the respective teams is as follows:

- a. Coordination Staff
 - (1) Course Director

- (2) Course Coordinator

- (3) Course Clerk

- b. Facilitation Staff (SME(s):

- (1) Lead Facilitator

- (2) 3-4 Facilitators (one per syndicates)

13. **Course Loading.** Course loading will be based on syndicates of eight participants. The following is intended to act as a guide for the loading of the course:

- a. Minimum Loading – 16

- b. Maximum Loading – 32

- c. Optimum Loading – 24

14. **Major Resource Requirements.** The following lists are intended to act as a guide to major resource requirements. It is expected that the exact list of resource requirements will vary from course to course. Ultimately, it is the responsibility of the course DS to determine exact resource requirements and the initial coordination meeting 10 weeks before the conduct of the course and staff this request through the proper channels.

- a. Facilities:

- (1) 1x Plenary – 24 participants

- (2) Up to 4 x Syndicate Rooms

- b. Administration:

- (1) 5 x Flip Charts with surplus paper

- (2) Central projection facility with speakers and video capability

- (3) 5 x laptops with projectors
- (4) 1 x laser printers
- (5) Access to a photocopier

15. **Course Evaluation Process.** The evaluation is meant to ensure that the training and education delivered is done efficiently and effectively as it helps to identify the institution's strengths and areas requiring improvement. The information collected provides feedback to the Systems Approach to Training. There are three types of course evaluation done:

- a. Daily Course Evaluation – This is done by an individual participant. The participant rates the Modules covered on that day against the preferred score. The scoring is based on the following criteria:
 - (1) 5-Excellent,
 - (2) 4-Very Good,
 - (3) 3-Good,
 - (4) 2-Average
 - (5) 1-Below Average.
- b. The participant further comments on the Module's content, relevance, strengths, and areas to improve. This information will be passed to Curriculum Design to track the course content and determine any changes required.
- c. Syndicate/Group Course Evaluation – This is done by syndicates at the end of the course. Collectively, members of each syndicate rate the course in terms of course expectation, course

content, facilitation, and administrative support (apply the same score scale as in Daily Evaluations). Additionally, they respond to questions provided under each rated area.

- d. Checklist after Action Review (AAR) Template – The previous two evaluations and the observations of the course and support staff will be used to fill in the AAR checklist for the course. Once compiled, these documents will form the basis of the AAR report which will be submitted by the Lead Facilitator to the Training Institution Commandant who will further staff the AAR to the Director for their information/action as necessary.

16. Triangulating the evaluation process is critical as it provides deeper insights and information. **See Annex B for Course Evaluations Templates.**

17. **Participant Assessment Process.** To ensure the maintenance of the standards expected for the training, each participant will be assessed by the course staff and assigned a grading based on their knowledge and participation in individual and syndicate assignments. **See Annex C for Participant Assessment Report Template.**

18. **Course Validation Process.** Where possible the validation process will be carried out in the field to assess the impact of the course on participants' job performance. The purpose of this effort is to ensure that the training and education delivered has accommodated the performance/knowledge gap between the initial participant level and that of the learning outcomes articulated during the training needs assessment

stage. The results will be used to improve the course content and methodology.

SECTION THREE – LEARNING OUTCOMES

19. **Learning Outcomes:** This course comprises 3 Learning Outcomes delivered in 15 days of instruction. There are a total of 114 periods of instruction / SBE, 2 periods of Senior Instructor Disposal and 6 periods of administration and course evaluation allocated in the optimum timetable. Each period covers 45 minutes. **See Annex A.**

Learning Outcome 1 UNDERSTANDING THE OPERATING ENVIRONMENT

20. **OBJECTIVE:** Enhance participants knowledge of the conventional operating environment, how it is impacted by explosive hazards and develop skills to mitigate the IED threat. This learning outcome comprises 23 periods of instruction in the following Modules:

- a. **Module 1.1 – Global Emerging threats.** At the end of this module, participants will be able to explain the IEDs threat concerning the global terrorism threats. (2x45 Periods)
- b. **Module 1.2 – Explosive Hazard Awareness.** At the end of this module, participants will be able to demonstrate an understanding of the threats posed by explosive hazards and employ mitigation measures. (10x45 Periods)

- c. **Module 1.3 – Vulnerable Points and Areas.** At the end of this module, the participants will be able to demonstrate the application of 5/25s, recognize vulnerable points and areas concerning explosive hazards, to explain the threat assessment process and interpret a threat summary. (3 x 45 Period)
- d. **Module 1.4 – Ground Sign Awareness.** At the end of this module, participants will be able to recognize and interpret the characteristics of GSA and its importance in search operations. (4x45 Periods)
- e. **Module 1.5 – Threat Assessment.** At the end of this module, participants will be able to explain the threat assessment process and interpret a threat summary. (3 x 45 Periods)
- f. **Module 1.6 – Incident Reporting.** At the end of this module, the participants will be able to demonstrate the application of the 5Cs in responding to explosive hazard emergencies. (2x45 periods)

Learning Outcome 2

SEARCH OPERATIONS

21. **OBJECTIVE:** Develop practical skills to conduct the full spectrum of intermediate search capability This learning outcome comprises 35 periods of instruction in the following Modules:

- a. **Module 2.1 – Introduction to Search.** At the end of this module, participants will be able to differentiate the levels of search and explain the capabilities and limitations of intermediate search. (3x45 Periods)
- b. **Module 2.2 – Basic Search.** At the end of this module, participants will be able to effectively conduct vehicle, person and baggage searches. (4x45 Periods)
- c. **Module 2.3 – Gender considerations in search operations.** At the end of this module, participants will be able to recognize methods of integrating gender perspectives in search operations. (4x45 Periods)
- d. **Module 2.4 – Route Search.** At the end of this module, participants will be able to effectively conduct a route search. (16x45 Periods).
- e. **Modules 2.5 – Area Search.** At the end of this module, participants will be able to effectively identify reference points and conduct an area search. (4x45 Periods)

- f. **Module 2.6 – Compound Search.** At the end of this module, participants will be able to identify threats and effectively conduct a compound search. (4x45 Periods)

Learning Outcome 3

PRACTICAL EXERCISES

22. **OBJECTIVE:** Apply lessons learnt to demonstrate a sufficiently high standard to deploy on operations in an IED threat environment This learning outcome comprises 56 periods of instruction in the following modules:

- a. **Module 3.1 a – Practical Exercises.** At the end of this exercise, participants will demonstrate key competencies in search operations. (52x45 Periods).
- b. **Module 3.1 b – Debrief and cleaning of equipment.** While course participants will be conducting cleaning and return of stores equipment, individuals will be debriefed on their performance. Participants who did not pass basic skill tests will be given an opportunity for a retest. (4x45 Periods)

SECTION FOUR-COURSE MODULE SPECIFICATION

Learning Outcome 1

UNDERSTANDING THE OPERATING ENVIRONMENT

23. MODULE 1.1 – GLOBAL EMERGING THREATS

- a. **TIME**: This module is allocated 2x45 periods.
- b. **TRAINING OBJECTIVE**: At the end of this module participants will be able to explain the IEDs threat concerning the global terrorism threats.
- c. **TEACHING POINTS**: The following main teaching points are contained in the delivery of this module:
 - (1) General history of IEDs
 - (2) Why do terrorists use IEDs
 - (3) IED threat picture
 - (4) Emerging terrorist threats
 - (a) Global and Regional perspectives
 - (5) Lessons learnt, challenges, recommendations and way forward to IED threats

- d. **METHODOLOGY**: This module will be introduced through the lecture method combined with class discussions and Q&A sessions.
- e. **REFERENCES**: The following references are available to support this module:
 - (1) OSCE (2008). Operational Guidelines for Working in a potentially Hazardous Environment. Folke Bernadotte Academy, Sweden. Author
 - (2) Rij, A.V. Bryce, H. Wilkinson, B. & Vining, M. (2017). Defining the Device: The need for International Humanitarian Standards for Improvised Explosive Device Disposal. Kings College London.
 - (3) The National Academics of Sciences, Engineering, Medicine. (2018). Key Recommendations: Reducing the Threat of Improvised Explosive Device Attacks by Restricting Access to Explosive Precursor Chemicals. USA: Author.
 - (4) UN General Assembly (2016). Countering the Threat Posed by Improvised Explosive Devices. Report by the Secretary-General A/71/187. USA: Author
 - (5) UNDP (2016). Mine Action for Sustainable Development. New York, USA: Author
 - (6) UNDPKO, DFS (2016). Guidelines: Improvised Explosive Device (IED) Threat

- Mitigation in Mission Setting (Ref 201614).
New York: Author
- (7) UNIDR (2015). Addressing Improvised Explosive Devices: Options and Opportunities to better Utilize UN Processes and Actors. Geneva, Switzerland: Author
- (8) UNMAS (2015). "Landmines, Explosives Remnants of Wars, and IED safety handbook." New York. USA ICBL-CMC (2018). "Cluster Munition Monitor" Geneva, Switzerland. Author
- (9) UNMAS (2018). United Nations Improvised Explosive Device Disposal Standards. Document Reference N. 2018.05. USA: Author.
- (10) US - DHS (April 2019). A fact sheet from National Academies and the Department of Homeland Security. IED Attack Fact Sheet: Improvised Explosive Devices. The USA. Author.
- (11) Longstreth K. The use of landmines violates human rights. In: Williams ME, ed. Human Rights: Opposing Viewpoints. San Diego, CA: Greenhaven Press; 1998:108–11

24. **MODULE 1.2 – EXPLOSIVE HAZARD AWARENESS**

- a. **TIME:** This module is allocated 10x45 periods.
- b. **TRAINING OBJECTIVE:** At the end of this module the participants will be able to demonstrate an understanding of the threats posed by explosive hazards and employ mitigation measures.
- c. **TEACHING POINTS:** The following main teaching points are contained in the delivery of this module:
- (1) Introduction to Explosive hazards
 - (a) Introduction to explosives
 - (b) Categories of explosive hazards
 - (i) ERWs (UXOs and AXOs)
 - (ii) Landmines
 - (iii) IEDs
 - (c) ERW combat indicators
 - (d) Impact of explosive hazards in PSO
 - (2) Introduction to Service Munitions
 - (b) Placed munitions
 - (i) Land mines
 - (ii) Maritime ordnance
 - (c) Thrown munitions
 - (i) Grenades

- (d) Projected munitions
 - (i) Projectiles
 - (ii) Mortars
 - (iii) Rockets
 - (iv) Missiles
 - (e) Dropped munitions
 - (i) Sub-munition
 - (ii) Air dropped weapons
 - (3) CIED fundamentals
 - (a) CIED pillars
 - (b) Operational activities
 - (c) CIED assets
 - (4) Forensic Awareness
 - (a) Understanding forensic awareness
 - (b) Types of evidence
 - (c) Examples of evidence
 - (d) Contamination issues
 - (5) Introduction to IED
 - (a) Definition of IEDs
 - (b) Parts of an IED
 - (c) IEDs initiation system
 - (i) Time
 - (ii) Command
 - (iii) Victim
 - (d) IED emplacement
 - (e) IED indicators (CMSA/AWARE)
 - CMSA
 - (i) Colours
 - (ii) Makers
 - (iii) Shapes
 - (iv) Atmospheric
 - AWARE
 - (i) Atmospheric changes
 - (ii) Warning Signs
 - (iii) Aiming Markers
 - (iv) Recognition of Ground Signs
 - (e) Examination of surroundings for an object out of place
- NB: The instructor shall produce dummy IED components during the delivery of this lesson.***
- d. **METHODOLOGY:** This module will be introduced through lecture, Q&A and a class activity practical.
 - e. **REFERENCES:** The following references are available to support this module:

- (1) ANZCTC (2017). Improvised Explosive Device (IED) Guidelines for Crowded Places. Australia: Author
- (2) Coupland R, Korver A. Injuries from anti-personnel mines: The experience of the International Committee of the Red Cross. *BMJ* 1991;331:1509–12.
- (3) Diaz, D., McCann, V. L. (2005). Tracking Signs of Man, Signs of Hope. A systematic Approach to the Art of Tracking Humans. USA
- (4) GICHD – SIPRI (June 2019). The Humanitarian and developmental impact of Anti –Vehicle mines: Global Mapping and analysis of Ani-Vehicle Mine Incidents in 2018. Geneva: Author
- (5) Keeley, R. (September 2003). Understanding Landmines and Mine Actions. Retrieved from: <http://web.mit.edu/demining/assignments/understanding-landmines.pdf>
- (6) UNDP (2016). Mine Action for Sustainable Development. New York, USA: Author
- (7) UNDPKO, DFS (2016). Guidelines: Improvised Explosive Device (IED) Threat Mitigation in Mission Setting (Ref 201614). New York: Author
- (8) UNIDR (2015). Addressing Improvised Explosive Devices: Options and Opportunities to better Utilize UN Processes and Actors. Geneva, Switzerland: Author
- (9) The United States Marine Corps Field Medical Training Battalion Camp Lejeune, NC 28542-0042 Fmso 211. Retrieved from: <https://www.trngcmd.marines.mil/Portals/207/Docs/FMTBE/Student%20Materials/FMSO%20Manual/211.pdf>
- (10) United States Marine Corps The Basic School Marine Corps Training Command Camp Barrett, Virginia 22134-5019: Improvised Explosive Devices (IED) B3I4118 Student Handout. Retrieved from: <https://www.usmcofficer.com/wp-content/uploads/2014/02/Improvised-Explosive-Devices.pdf>
- (11) UNMAS (2015). "Landmines, Explosives Remnants of Wars, and IED safety handbook." USA: Author.
- (12) UNMAS (2018). United Nations Improvised Explosive Device Disposal Standards. Document Reference N. 2018.05. USA: Author
- (13)
- (14) UNMAS. Improvised Explosive Device Lexicon: An IED Lexicon for People Working in Environments Contaminated

- with Improvised Explosive Devices. New York, USA: Author.
- (15) US - DHS (April 2019). A fact sheet from National Academies and the Department of Homeland Security. IED Attack Fact Sheet: Improvised Explosive Devices. USA: Author. Retrieved from: https://www.dhs.gov/sites/default/files/publications/prep_ied_fact_sheet.pdf
- (16) US – DHS, Office of Bombing Prevention. IED and Explosive Effects Fundamentals (DHS- MITG 253) Version 4. USA: Author. Retrieved From: https://na.eventscloud.com/file_uploads/170e63337bebca0287c1aaf3509af6d2_IEDExplosiveEffectsFundamentals.pdf
- (17) Walle, M. Jennings, N. Walle, R. Safety and Health in small scale surface Handbook, Sectoral Activities Working Paper (WP 168). ILO Geneva, Switzerland.
- (18) iAuditor (2020). Incident Report Guide: 5 Elements of a Good Incident Report. Safety Culture. Author
- (19) UNESCO (2017). Safety Guide for Journalists: A handbook for Reporters in high-risk environments. France: Author
25. **MODULE 1.3 – 5/25s, Vulnerable Points/Areas and CAGE & CMSA**
- a. **TIME:** This module is allocated a 2x45 period for lectures and discussions.
- b. **TRAINING OBJECTIVE:** At the end of this module the participants will be able to recognize vulnerable points and areas concerning explosive hazards.
- c. **TEACHING POINTS:** The following main teaching points are contained in the delivery of this module:
- (1) Introduction to 5/25s
 - (2) Introduce and explain 5Cs
 - (a) Confirm
 - (b) Clear
 - (c) Cordon
 - (d) Control
 - (e) Call
 - (3) Demonstration of 5/25s Definitions
 - (a) Vulnerable points
 - (b) Vulnerable areas
 - (2) Types of Vulnerable Points
 - (a) Terrain oriented vulnerable point
 - (b) The situationally oriented vulnerable point

- (3) A detailed description of the terrain and situational oriented vulnerable points about:
- (a) Time
 - (b) Command
 - (c) VO-IEDs
- (4) Introduction to CMSA
- (a) Colours
 - (b) Markers
 - (c) Shapes
 - (d) Atmospheric
- d. **METHODOLOGY**: This module will be introduced through lecture combined with participatory approaches, use of appropriate examples, question and answer (Q&A) and experience sharing
- e. **REFERENCES**: The following references are available to support this module.
- (1) GICHD – SIPRI (June 2019). The Humanitarian and developmental impact of Anti –Vehicle mines: Global Mapping and analysis of Ani-Vehicle Mine Incidents in 2018. Geneva: Author
 - (2) UNDP (2016). Mine Action for Sustainable Development. New York, USA: Author
 - (3) UNMAS (2018). United Nations Improvised Explosive Device Disposal Standards. Document Reference N. 2018.05. USA: Author
 - (4)
 - (5) Owen (November 2017). Commander’s Guide to Counter Identified Explosive Devices. UK
 - (6) JSP 364,(September 2016). Joint Service Explosive Ordinance Disposal and Search Manual. Part 2. https://www.jcs.mil/Portals/36/Documents/Doctrine/pubs/jp3_42.pdf

MOD 1.3: EXERCISE - IMMEDIATE ACTION AND 5Cs

TIME: 1x45 mins Period

Objective

To supplement the classroom lessons and reinforce the participants understanding of basic explosive hazard mitigation measures.

Guidance

Following the classroom lessons the instructor will conduct a practical demonstration to the entire class on the following procedures.

5/25m Checks

An instructor, using a demonstration troop(s), should explain the process of conducting a 5/25m check and the purpose of the check. This demonstration should cover both mounted and dismounted operations.

Route Check -Also known as VP 360

Using a vehicle and 4 demonstration troops the instructor should explain the process of how a route check is conducted. The demonstration should show a vehicle approaching a Vulnerable Point and must cover:

Stop Short.

5/25m check

Isolation/360 degree check

Search forward using GSA.

NB: HHMD are not required for this demonstration.

5Cs

Following on from the previous two demonstrations, the instructor should now demonstrate how to conduct a 5Cs operations in basic terms. This must cover:

Confirm

Clear

Call

Cordon

Control

26. MODULE 1.4 – GROUND SIGN AWARENESS

- a. **TIME:** This module is allocated 4x45 periods.
 - b. **TRAINING OBJECTIVE:** At the end of this module the participants will be able to recognize and interpret ground signs while undertaking search operations.
 - c. **TEACHING POINTS:** The following main teaching points are contained in the delivery of this module:
 - (1) Definition of GSA
 - (2) Use of sense
 - (3) Utility of ground sign
 - (4) Why things are seen
- (a) Shape
 - (b) Shine
 - (c) Silhouette
 - (d) Shadow
 - (e) Spacing
 - (f) Sudden Movement
- (5) Methods of observation
 - (a) Scanning
 - (b) Searching
 - (6) Sign
 - (a) Definition of sign

- (b) Characteristics of ground sign
 - (i) Regularity
 - (ii) Flattening
 - (iii) Transfer
 - (iv) Colour change
 - (v) Discardables
 - (vi) Disturbance
 - (c) Categories of sign
 - (d) Classification of a sign
 - (7) Dynamics of a footprint
 - (8) Factors affecting sign
 - (a) Sign and spoor
 - (b) Terrain
 - (c) Climatic condition
 - (d) Time
 - (9) Judging the age of sign
 - (a) Consideration is needed to judge the age of the sign
 - (b) Methods employed to determine the age of ground sign
 - (10) The information gained from the sign
- d. **METHODOLOGY:** This module will be introduced through the lecture method combined with Q&A, practical exercises and demonstrations.

- e. **REFERENCES:** The following references are available to support this module:
- (1) ANZCTC (2017). Improvised Explosive Device (IED) Guidelines for Crowded Places. Australia: Author
 - (2) Corderoy, J. (2014). Material Harm. London: Action on Armed Violence. The UK.
 - (3) David, D. & McCann (2005). Tracking Signs of Man, Signs of Hope. A systematic Approach to the Art of Tracking Humans. USA
 - (4) Diaz, D., McCann, V. L. (2005). Tracking Signs of Man, Signs of Hope. A systematic Approach to the Art of Tracking Humans. USA
 - (5) Donelan, S. (1988). Tactical Tracking Operations: The Essential guide for military and police Trackers. Colorado – USA
 - (6) Gencer, U. & Landaeta, R. Unal, R. & Pinto, C. et al. (2012). An analysis of factors affecting the effective use of knowledge management in counter-improvised explosive device (C-IED) operations. 415-424. Old Dominion University.

- (7) Multi-National Corps (2004). Improvised Explosive Devices, Smart Cards: ASOF27OCT2004. Iraq.
- (8) UNDPKO/DFS Guidelines (2016). Improvised Explosive Device (IED) Threat Mitigation in Mission Setting. New York: Author
- (9) United States Marine Corps The Basic School Marine Corps Training Command Camp Barrett, Virginia 22134-5019: Improvised Explosive Devices (IED) B3I4118 Student Handout. USA: Author.
- (10) UNMAS (2018). United Nations Improvised Explosive Device Disposal Standards. Document Reference no. 2018.05. New York. USA: Author
- (11)
- (12) CJTF – 7 (January 2004). OIF Smartcard Version 1.A. Retrieved from: <https://fas.org/irp/doddir/army/ied-smartcard.pdf>
- (13) Kirtley, P. (7 July 2012). Tracking: The 6 Key Characteristics of Sign. Retrieved from: http://frontierbushcraft.com/2012/07/07/tracking-key-characteristics-of-sign/?doing_wp_cron=1618559506.7816720008850097656250

SYNDICATE ACTIVITY 1.4: SIGN PIT LESSONS

TIME ALLOCATED: 1 x 45 Period

EXERCISE OBJECTIVE:

At the end of this exercise the participants will be able to apply knowledge gained on Ground Sign Awareness (GSA)

EXERCISE GUIDANCE

This exercise will be a confirmation exercise for lessons learnt on day 2.

The exercise will have 3 different instructors who will be required to come up with 3 different syndicate activities for participants.

Each instructors will manage two sign pits

Each syndicate will have to pass by each sign pit to investigate and identify the characteristics present and discuss with the instructor

The participants will be in 3 syndicate groups and will tackle the following:

Syndicate A: Regularity and Flattening

Syndicate B: Colour change and Disturbance

Syndicate C: Transfer and Discardables

27. **MODULE 1.5 – THREAT ASSESSMENT**

- a. **TIME:** This module is allocated 3x45 periods.
- b. **TRAINING OBJECTIVE:** At the end of this module participants will be able to explain the threat assessment process and interpret a threat summary.
- c. **TEACHING POINTS:** The following main teaching points are contained in the delivery of this module:
 - (1) Methods of attack
 - (a) Shoot
 - (b) Public disorder
 - (c) Hoax
 - (d) IEDs and suicide
 - (e) Complex attacks
 - (2) Sources of information and intelligence
 - (a) Maps
 - (b) Historical Data
 - (c) Enemy Intelligence
 - (d) Human Terrain Analysis
 - (3) Enemy Intent
 - (4) Enemy Capability
 - (5) Enemy opportunity to use IEDs
 - (6) Issuing a threat summary

- (7) Model Exercise
- d. **METHODOLOGY:** This module will be introduced through a lecture combined with a question and answer (Q&A) and a group activity.
- e. **REFERENCES:** The following references are available to support this module:
 - (1) Donelan, S. (1988). Tactical Tracking Operations: The Essential guide for military and police Trackers. Colorado – USA
 - (2) GICHD – SIPRI (June 2019). The Humanitarian and developmental impact of Anti –Vehicle mines: Global Mapping and analysis of Ani-Vehicle Mine Incidents in 2018. Geneva: Author
 - (3) NaCTSO (June 2017). Crowded Places Guidance. Version 1.00. Britain: Author.
 - (4) UNDP (2016). Mine Action for Sustainable Development. New York, USA: Author
 - (5) UNDPKO/DFS Guidelines (2016). Improvised Explosive Device (IED) Threat Mitigation in Mission Setting. New York: Author
 - (6) UNMAS (2018). United Nations Improvised Explosive Device Disposal Standards. Document Reference no. 2018.05. New York. USA: Author

MOD 1.5 – SYNDICATE BASED ACTIVITY

THREAT ASSESSMENT MODEL EXERCISE

TIME: 1x45 mins

Objective

To provide the participants with an understanding of how to practically employ a threat assessment summary.

Guidance

In their search teams participants will be issued the threat summary and asked to brief answers to the 3 questions in the instructor guidance. This activity will be done in 45 mins.

The instructors will be required to build a model of a route with varying terrain and features. The participants will be asked to plan a vehicle move on the route depicted on the model. The participants will then be issued with a threat summary.

NB: For smooth running of this exercise, 2 instructors will be required to build the model prior to the exercise to allow for an immediate transition from the threat assessment lesson to the exercise.

The instructor is to ensure that the model allows for a number of VPs to be identified according to the above Threat Summary.

THREAT SUMMARY NARRATIVE

The enemy are a 4-6 man insurgent group from outside the local area. They are seeking to attack AU convoys, particularly targeting command vehicles and soft skin logistic vehicles. Their overall objective is to discredit AU and reduce their freedom of movement in order to gain local influence and win over popular support. The enemy have a small arms capability (AK variants only) and an IED capability. They are able to employ VO, CW and RC. As access to commercial and military explosive is limited, the insurgent usually employs blast and blast/fragmentation main charges from HME. The enemy has not yet developed EFP or DFC. These attacks are sometime followed up with small arms attacks with the enemy seeking to escape before becoming decisively engaged. They usually seek to initiate attacks with IEDs at channeled areas on dirt road particularly where they have good observation and escape routes. The enemy is aware of the UN pattern of early morning patrols so they use the night to dig in devices and then attack in the morning.

Using the threat summary, participants will be expected to identify:

Explain why, locations on the model that led them to an enemy attack

What type of IED will the enemy use and why?

What mitigation measures can be employed?

28. **MODULE 1.6– INCIDENT REPORTING**

- a. **TIME:** This module is allocated 2x45 periods for lecture and syndicate discussions.
- b. **TRAINING OBJECTIVE:** At the end of this module the participants will be able to demonstrate the application of 5/25s and 5Cs in responding to explosive hazard emergencies.
- c. **TEACHING POINTS:** The following main teaching points are contained in the delivery of this module:
 - (1) Incident reporting
 - (a) Key information in an incident report
 - (i) 5 Ws & H (Who, What, Where, When, Why and How)
 - (b) Importance of information sharing
 - (c) Describe the roles of partner agencies
- b. **METHODOLOGY:** This module will be introduced through the lecture method combined with participatory approaches, use of appropriate examples, question and answer (Q&A).
- c. **TRAINING AID:** Power-points
- d. **REFERENCES:** The following references are available to support this module.
 - (1) CJTF – 7 (January 2004). OIF Smartcard Version 1. A. Retrieved from:

<https://fas.org/irp/doddir/army/ied-smartcard.pdf>

- (2) The National Academics of Sciences, Engineering, Medicine. (2018). Key Recommendations: Reducing the Threat of Improvised Explosive Device Attacks by Restricting Access to Explosive Precursor Chemicals. USA: Author.
- (3) The United States Marine Corps Field Medical Training Battalion Camp Lejeune, NC 28542-0042 Fmso 211. Retrieved from:
<https://www.trngcmd.marines.mil/Portals/207/Docs/FMTBE/Student%20Materials/FMSO%20Manual/211.pdf>
- (4) United States Marine Corps The Basic School Marine Corps Training Command Camp Barrett, Virginia 22134-5019: Improvised Explosive Devices (IED) B3I4118 Student Handout. USA: Author. Retrieved from:
<https://www.usmcofficer.com/wp-content/uploads/2014/02/Improvised-Explosive-Devices.pdf>
- (5) UNMAS (2015). Landmines, Explosive Remnants of War and IED Safety Handbook, 3rd Edition. New York. Author.
- (6) UNMAS (2018). United Nations Improvised Explosive Device Disposal

Standards. Document Reference no.
2018.05. New York. USA: Author

- (7) iAuditor (2020). Incident Report Guide: 5 Elements of a Good Incident Report. Safety Culture. Author
- (8) UNESCO (2017). Safety Guide for Journalists: A handbook for Reporters in high-risk environments. France: Author

Learning Outcome 2

SEARCH OPERATIONS

29. MODULE 2.1 – INTRODUCTION TO SEARCH

- a. **TIME:** This module is allocated 3x45 periods for lecture and assists demo.
- b. **TRAINING OBJECTIVE:** At the end of this module participants will be able to differentiate the levels of search and explain the capabilities and limitations of intermediate search.
- c. **TEACHING POINTS:** The following main teaching points are contained in the delivery of this module:
 - (1) Definition of Search (What are we looking for)
 - (2) Objectives of Search
 - (a) Offensive
 - (b) Defensive
 - (3) Levels of Search
 - (a) Basic
 - (b) Intermediate
 - (c) Advanced
 - (4) Different Types of search
 - (5) Principles of search

- (a) Systematic
 - (b) Flexible
 - (c) Focused
 - (d) Safe
- (6) Search Team Structure and their roles
 - (7) Search documentation
 - (a) Functions of search documentations
 - (b) Types of documentation
 - (c) Examples of search documentation
 - (8) List the types of search equipment
 - (a) In-service handheld metal detector e.g
 - (i) Ebinger
 - (ii) Hoodlum
 - (b) Hook/Wire detector
 - (c) Under vehicle mirrors
- d. **METHODOLOGY:** This module will be introduced through the lecture method combined with question and answer (Q&A).
 - e. **TRAINING AID:** Search Document report template **See Annex D**
 - f. **REFERENCES:** The following references are available to support this module:

- (1) ANZCTC (2017). Improvised Explosive Device (IED) Guidelines for Crowded Places. Australia: Author
- (2) Homeland Security: IED Search Procedures Overview. Retrieved from: https://na.eventscloud.com/file_uploads/2720d345f3a0ca6e71e173f07bed63ac_DH_SIEDSearchProcedures.pdf
- (3) Homeland Security: Security and Resiliency Guide Counter-Improvised Explosive Device (C-IED) Annex for Lodging Stakeholders. Retrieved from: https://www.cisa.gov/sites/default/files/publications/Security-and-Resiliency-Guide-Lodging-Annex_1.pdf
- (4) Multi-National Corps (2004). Improvised Explosive Devices, Smart Cards: ASOF27OCT2004. Iraq. Retrieved From: <https://info.publicintelligence.net/OIF-IED-SmartCard.pdf>
- (5) UNMAS (2018). United Nations Improvised Explosive Device Disposal Standards. Document Reference no. 2018.05. New York. USA: Author
- (6) USA Homeland Security (May 2012). Sports Venue Bag Search Procedures Guide Commercial Facilities Sector-Specific Agency: Author
- (7) USA Homeland Security: TRIP WIRE. Improvised Explosive Device Awareness - Course of Actions. Retrieved from: <https://cdn.fedweb.org/137/268/IED%2520Awareness%2520Course%2520of%2520Actions.pdf>
- (8) HMA Global SOPs (2018). CHAPTER 7: IED Search & Clearance. Retrieved from: https://www.nolandmines.com/Global_SOPs/V3.0_Global_SOPs_Chap_7_HIED_Search_and_Clearance.pdf

MOD 2.1: SEARCH DOCUMENT REPORT TEMPLATE
(SECTION A)

MOD 2.1: SEARCH DOCUMENT REPORT TEMPLATE
(SECTION B)

**MOD 2.1: SEARCH DOCUMENT REPORT TEMPLATE
(SECTION B Cont...)**

**MOD 2.1: ASSET DEMO FOR MILITARY WORKING
DOGS**

TIME: 1x45 Period

OBJECTIVE: To supplement the classroom lessons and reinforce the participants understanding of the additional military assets that a Search Team is likely to interact with on a search operation.

GUIDANCE:

The instructor, supported by the necessary subject matter experts, will conduct a practical demonstration to the entire class on the following assets:

**MOD 2.1: ASSET DEMO FOR MILITARY WORKING
DOGS Cont...**

Military Working Dogs

Explosive Detection Dog

Infantry Patrol Dog/Force Protection
Dog.

In a combination of presentation and demonstration the instructor should cover the following subjects:

The dog and handler capability.

The dog and handlers limitations.

Planning considerations and how best they should be employed within a search operation.

IEDD. The instructors, through a controlled demonstration of an explosive find, should demonstrate the process of a search team support to IEDD. The instructor should also cover:

The IEDD team sequence of events for neutralization /Destroy of IED

How the Search Team provide support to the IEDD/EOD team (long and short isolation).

30. **MODULE 2.2 – BASIC SEARCH**

- a. **TIME:** This module is allocated 4x45 periods.
- b. **TRAINING OBJECTIVE:** At the end of this module participants will be able to effectively conduct vehicle, person and baggage searches.
- c. **TEACHING POINTS:** The following main teaching points are contained in the delivery of this module:
 - (1) Person Search and their baggage
 - (a) Categories of person search
 - (i) Initial
 - (ii) Detailed
 - (iii) Strip
 - (iv) Intimate
 - (2) Vehicle search including its occupants and their baggage
 - (a) Categories of vehicle search
 - (i) Initial
 - (ii) Primary
 - (iii) Secondary
- d. **METHODOLOGY:** This module will be introduced through the lecture method combined with plenary discussions and Question and Answer (Q&A).

- e. **REFERENCES:** The following references are available to support this module:
 - (1) ANZCTC (2017). Improvised Explosive Device (IED) Guidelines for Crowded Places. Australia: Author
 - (2) Homeland Security: IED Search Procedures Overview. Retrieved from: https://na.eventscloud.com/file_uploads/2720d345f3a0ca6e71e173f07bed63ac_DH_SIEDSearchProcedures.pdf
 - (3) Homeland Security: VBIED Search Procedures: Student Guide. Retrieved From: https://na.eventscloud.com/file_uploads/12062e24d2fd637ca8ba1c5f6c5c73fd_VBIEDStudentGuide.pdf
 - (4) Homeland Security: Security and Resiliency Guide Counter-Improvised Explosive Device (C-IED) Annex for Lodging Stakeholders. Retrieved from: https://www.cisa.gov/sites/default/files/publications/Security-and-Resiliency-Guide-Lodging-Annex_1.pdf
 - (5) Multi-National Corps (2004). Improvised Explosive Devices, Smart Cards: ASOF27OCT2004. Iraq. Retrieved From: <https://info.publicintelligence.net/OIF-IED-SmartCard.pdf>
 - (6) UNMAS (2018). United Nations Improvised Explosive Device Disposal

Standards. Document Reference no.
2018.05. New York. USA: Author

- (7) USA Homeland Security (May 2012).
Sports Venue Bag Search Procedures
Guide Commercial Facilities Sector
Specific Agency: Author

MOD 2.2: BASIC SEARCH

TIME: 3x45 mins Periods

Exercise Objective:

At the end of this exercise the participants will be able to conduct vehicle, person and baggage search using the correct procedures.

Exercise Guidance:

This exercise will require the following:

Vehicle search

Role player

Baggage

Handheld detectors

Search mirrors

Participants will be divided into four groups of seven each and will be required to conduct search in rotation on:

Vehicle search

Person and baggage

31. MODULE 2.3 – GENDER CONSIDERATIONS IN SEARCH OPERATIONS

- a. **TIME:** This module is allocated 4x45 periods.
- b. **TRAINING OBJECTIVE:** At the end of this module participants will be able to recognize methods of integrating gender perspectives in search operations.
- c. **TEACHING POINTS:** The following main teaching points are contained in the delivery of this module:
 - (1) Historical background of the gender debate and approaches
 - (a) Women in Development
 - (b) Women and Development
 - (c) Gender and Development
 - (2) Gender Concepts
 - (a) Definitions of Concepts
 - (i) Gender and Sex
 - (ii) Gender equality and equity
 - (iii) Gender-neutral
 - (iv) Gender Analysis
 - (v) Gender spectrum
 - (vi) Gender discrimination
 - (vii) Gender integration
 - (3) Gendered impact of IEDs

- (4) Integrating gender in search operations
- (5) Conflict-Related Sexual Violence (CRSV)
 - (a) Trends and patterns
 - (b) Warning Indicators
 - (c) Why it is a security issue
 - (d) Response and Prevention
- (6) Sexual Exploitation and Abuse (SEA)
 - (a) Definition of terms
 - (b) Duty to protect and serve zero-tolerance policy
 - (c) Uniformed Standards of SEA
 - (d) Consequences of SEA
 - (e) Responsibilities of Peace Keepers
- d. **METHODOLOGY:** This module will be introduced through lecture combined with participatory approaches, use of appropriate examples, question and answer (Q&A) and experience sharing.

NB: The facilitator will choose one film for participants to watch during this session. Participants can watch the other videos in their own free time.
- e. **TRAINING AID:** Powerpoints, Videos.
- f. **REFERENCES:** The following references are available to support this module.

- (1) Aning K and Edu-Afful F (2013) Unintended impacts and the gendered consequences of peacekeeping economies in Liberia. *International Peacekeeping*
- (2) Buckingham, S. (2000). *Gender and Environment*. Hartfield: Psychology Press.
- (3) Cheldelin, S. & Eliatamby, M. (red.) (2011). *Women waging war and peace: international perspectives of women's roles in conflict and post-conflict reconstruction* New York: Continuum.
- (4) Cockburn C (2001). *The gendered dynamics of armed conflict and political violence*. In: Moser CON and Clark FC (eds) *Victims, Perpetrators or Actors? Gender, Armed Conflict and Political Violence*. London: Zed Books
- (5) Cockburn C and Hubic M (2002) *Gender and the peacekeeping military: A view from Bosnian women's organizations*. In: Cockburn C and Zarkov D (eds) *The Postwar Moment: Militaries, Masculinities, and International Peacekeeping*. London: Lawrence & Wishart
- (6) Connell, R. (2009). *Confronting Equality: Gender, Knowledge and Global Change*. Cambridge: Polity.
- (7) *Convention on the Elimination of All Forms of Discrimination Against Women (CEDAW)*
- (8) *Gender mainstreaming in development programming (2015)*. UN entity for gender equality and the empowerment of women, UN Women.
- (9) Higate P (2004) *Gender and Peacekeeping Case Studies: The Democratic Republic of the Congo and Sierra Leone*. Institute for Security Studies Monograph 91. Pretoria: Institute for Security Studies.
- (10) ICC. (2014). "Policy Paper on Gender and Gender-Based Crimes." Rome Statute: Author
- (11) Jennings KM (2008) *Protecting Whom? Approaches to Sexual Exploitation and Abuse in UN Peacekeeping Operations*. Fafo report 2008:36. Oslo: Fafo.
- (12) Kalbfleisch, P., & Cody, M. (2012). *Gender Power and Communication in Human Relationships*. New York: Routledge.
- (13) Matilda, C. (2016). *Conflict Relates Sexual Violence a Cross-National Comparison of circumstances related to States Forces*. Stockholm: Swedish Defence University.
- (14) Meintjes S, Pillay A and Turshen M (eds) (2001) *The Aftermath: Women in Post-*

- conflict Transformation. London: Zed Books.
- (15) Rawhide, B. Etchart. L, Onubogu. E. Tina. J, (2005) Gender Mainstreaming In Conflict Transformation Building Sustainable Peace. London: Common wealth Secretariat.
 - (16) Simic O (2012) Regulation of Sexual Conduct in UN Peacekeeping Operations. Heidelberg: Springer.
 - (17) UN. (2016). Conflict-Related Sexual Violence (CRSV) STM Manual. New York: Author
 - (18) UN. United Nations Security Council Resolution. (2000).New York: Author.
 - (19) UNSCR 1325 (2000), 1820 (2008), 1888 (2009), 1889 (2009), 1960 (2010), 2106 (2013), 2122 (2013)
 - (20) Wharton, A. (2011). The Sociology of Gender: An Introduction to Theory and Research. Hoboken: John Wiley & Sons

MOD 2.3: FILM: COMBATING CRSV: PREVENT, DETER AND PROTECT

TIME: 10 Mins

Objective

To raise the participants' interest on what peacekeepers must do to combat Conflict Related Sexual Violence in a conflict environment and what they are likely to face when they have been deployed.

Film Description

The United Nations Departments of Peacekeeping Operations and Field Support have developed this training video consisting of key messages for the mission leadership, planners as well as field practitioners, on effective prevention and response to CRSV. This video will enable them, and United Nations uniformed peacekeepers to better understand their responsibilities to protect civilians from sexual violence and to further strengthen prevention and accountability on CRSV.

Guidance

After watching the film, the participants with the guidance of the facilitator will engage in plenary discussion to draw out the critical aspects of CRSV.

**MOD 2.3: FILM – OUR BODIES THEIR BATTLE
GROUND**

TIME: 20 MINS

Objective

To raise the participants' interest on the effects and impacts of CRSV in PSO.

Film Description

This film highlights the crisis facing women, girls and infants throughout the world, both during conflict and in its wake. This film gives a voice to victims of rape in The Democratic Republic of the Congo and Liberia.

Guidance

After watching the film, the participants with the guidance of the facilitator will discuss the effects and impacts of CRSV in a PSO setting.

MOD 2.3: FILM – TO SERVE WITH PRIDE

TIME: 21 MINS

Objective

Raise awareness among UN staff and related personnel of the widespread occurrence of Sexual Exploitation and Abuse (SEA), the seriousness of the problem and what should be done to prevent and respond to it.

Film Description

This short film addresses the problem of sexual exploitation and abuse by UN staff and related personnel. The film is a useful tool to better understand our role and responsibilities in preventing and responding to such exploitation and abuse (SEA).

MOD 2.3: FILM – THEY SLEPT WITH ME

TIME: 20 MINS

Objective

To raise the participants' interest on the effects and impacts of CRSV in PSO.

Film Description

This short documentary shares the testimonies of several male survivors, and raises critical questions about the search for justice for conflict-related sexual violence. The questions raised by men are not unrelated to those asked by women survivors: will the government ever pay 'dowry' for what they did to me? Can someone who survives really tell their story in a formal court setting where it will be heard by many people, provoking the terrible phenomenon of self-imprisonment whereby survivors barely leave their own homes for fear of the stigma they will face?

Guidance

After watching the film, the participants with the guidance of the facilitator will discuss the effects and impacts of CRSV in a PSO setting.

32. **MODULES 2.4 – ROUTE SEARCH**

- a. **TIME:** This module is allocated 16x45 periods.
- b. **TRAINING OBJECTIVE:** At the end of this module participants will be able to effectively conduct a route search.
- c. **TEACHING POINTS:** The following main teaching points are contained in the delivery of this module:
 - (1) Differentiate between route check and route search
 - (2) Phases of route check
 - (a) Stop short
 - (b) VP 360
 - (c) Search forward
 - (3) Phases of route search
 - (a) Stop Short Point
 - (b) Road party shake out
 - (c) Temporary halt (To form ICP)
 - (d) Isolation party (Falt figure of 8)
 - (e) Road Party
 - (4) Support to EOD/IEDD team Phases
 - (a) Establish a safe EOD/ICP, operator to choose, 5/25s
 - (b) Long isolation (50-75 meters)

- (c) Short isolation (50-75 meters)
 - (d) EOD action until target declared explosively safe
 - (e) Consideration for secondary devices?
 - (i) If there could be another device... it must be searched!
- (5) Search Techniques
- (a) Use of Handheld metal detector
 - (b) Sweeping techniques
 - (c) Confirmation drills
 - (d) Detection lane 1&2
- d. **METHODOLOGY**: This module will be introduced through the lecture method combined with plenary discussions and Question and Answer (Q&A).
- e. **REFERENCES**: The following references are available to support this module:
- (1) ANZCTC (2017). Improvised Explosive Device (IED) Guidelines for Crowded Places. Australia: Author
 - (2) Homeland Security: IED Search Procedures Overview. Retrieved from: https://na.eventscloud.com/file_uploads/2720d345f3a0ca6e71e173f07bed63ac_DH_SIEDSearchProcedures.pdf
 - (3) Multi-National Corps (2004). Improvised Explosive Devices, Smart Cards: ASOF27OCT2004. Iraq. Retrieved From: <https://info.publicintelligence.net/OIF-IED-SmartCard.pdf>
 - (4) UNMAS (2018). United Nations Improvised Explosive Device Disposal Standards. Document Reference no. 2018.05. New York. USA: Author
 - (5) Homeland Security: Security and Resiliency Guide Counter-Improvised Explosive Device (C-IED) Annex for Lodging Stakeholders. Retrieved from: https://www.cisa.gov/sites/default/files/publications/Security-and-Resiliency-Guide-Lodging-Annex_1.pdf
 - (6) Military Engineering Volume II, Field Engineering Pamphlet No.11, Search. Ministry of Defence. UK

MOD 2.4: DETECTION LANE 1 & 2 EXERCISE

TIME: 4x45 mins Periods

Objective

To practice the participants in the correct individual search techniques.

Guidance

The instructors are to mark out a number of 2m wide lanes in the sandpit. The instructor will then place a number of targets of varying size and depths within the lanes. The students are to be instructed to:

Correctly set up the metal detector.

Commence an individual search of their lane ensuring:

Detector head kept a constant distance from the ground

Maintain the half-step walking method

Maintain a smooth and constant sweep speed

They visually scan ahead of the search area considering Ground Sign.

Carry out correct drill when a positive reading is registered on the detector. This should include:

Initial investigation and pin pointing

Confirmation drill.

Once instructor is satisfied the student is to proceed with the remainder of the lane.

NB: Instructor should manage the participant rotation through the lanes to ensure each participant has a fair amount of time to practice.

MOD 2.4: INSTRUCTOR DEMONSTRATION

Objective: To practically demonstrate and enhance the participants understanding of the process and mechanics of a route search task.

Guidance: The instructors will be required to practice and rehearse prior to the lesson. The Lead Instructor will require 7 role players and 1-2 vehicles. Selecting a suitable area to represent a route search, the participants are to observe a complete task done at an increased speed by the role players. During the demo, the Lead Instructor is to narrate the processes and provide explanation of each activity. The demonstration must cover the following sequence:

Stop short point procedure

Establishment of an ICP

Flat figure of 8 isolation

Search of the route

Confirmation drill

Find drill

Temporary halt and establishment of second ICP prior last crossover

NB. The Lead Instructor is to ensure that correct distances are used in the demo, where this is not possible, (s)he should clarify this with the students. In addition, the role players are to be correctly dressed and equipped to maximize the reality of the demo.

MOD 2.4: PARTICIPANT ROUTE SEARCH PRACTICE

Objective:

To practice the participants in the correct procedure of each stage of a route search.

Guidance:

Following the Route Search Demo, the student will be divided into their Search Teams and each allocated an Instructor. With the instructor providing guidance and correcting the students where necessary, the students should practice each stage of the route search spending 45 mins on each of the following areas:

SSP, 5/25 and establishing the ICP

Flat figure of 8 isolation

Search forward including confirmation and find drills.

NB: The instructors are to ensure the student have a realistic area to practice in and that they are provided all the necessary equipment to practice.

33. **MODULES 2.5 – AREA SEARCH**

- a. **TIME:** This module is allocated 4x45 periods.
- b. **TRAINING OBJECTIVE:** At the end of this module participants will be able to effectively identify reference points and conduct an area search.
- c. **TEACHING POINTS:** The following main teaching points are contained in the delivery of this module:
 - (1) Identify the 3 types of cache/hides
 - (a) Long term hide
 - (b) Transit hide
 - (c) Short term hide
 - (2) Characteristics and threats associated with a cache/hide
 - (3) Identifying reference points
 - (4) 6 phases to an Area Search
 - (a) Establishing and ICP
 - (b) Select Reference Points
 - (c) Walk the boundary
 - (d) Search reference points
 - (e) Search boundaries
 - (f) Search Open Area
- d. **METHODOLOGY:** This module will be introduced through the lecture method combined with

plenary discussions and Question and Answer (Q&A).

e. **REFERENCES:** The following references are available to support this module:

- (1) ANZCTC (2017). Improvised Explosive Device (IED) Guidelines for Crowded Places. Australia: Author
- (2) Homeland Security: IED Search Procedures Overview. Retrieved from: https://na.eventscloud.com/file_uploads/2720d345f3a0ca6e71e173f07bed63ac_DH_SIEDSearchProcedures.pdf
- (3) Multi-National Corps (2004). Improvised Explosive Devices, Smart Cards: ASOF27OCT2004. Iraq. Retrieved From: <https://info.publicintelligence.net/OIF-IED-SmartCard.pdf>
- (4) UNMAS (2018). United Nations Improvised Explosive Device Disposal Standards. Document Reference no. 2018.05. New York. USA: Author
- (5) Homeland Security: Security and Resiliency Guide Counter-Improvised Explosive Device (C-IED) Annex for Lodging Stakeholders. Retrieved from: https://www.cisa.gov/sites/default/files/publications/Security-and-Resiliency-Guide-Lodging-Annex_1.pdf

MOD 2.5: PARTICIPANTS AREA SEARCH PRACTICE

TIME ALLOCATED: 2x45 Periods

Objective:

To practically demonstrate and enhance the participants understanding of the process and mechanics of an area search task.

Guidance:

The instructors are to take the participants to a suitably sized location to conduct an instructor led walk thorough of an Area Search. At each phase of the search, the instructor will first explain and then physically walk through the process, providing clarification of what each search team member should be doing. On completion of the walk through, the instructor should ask the participants under the guidance of the Search Advisor and Team Commander to carry out the Area Search at an increased speed.

34. **MODULES 2.6 – COMPOUND SEARCH**

- a. **TIME:** This module is allocated 4x45 periods.
- b. **TRAINING OBJECTIVE:** At the end of this module participants will be able to identify threats and effectively conduct a compound search.
- c. **TEACHING POINTS:** The following main teaching points are contained in the delivery of this module:
 - (1) 3 levels of compound search
 - (a) Basic
 - (b) Intermediate
 - (c) Advanced
 - (2) Threats within a compound
 - (3) Vulnerable points
 - (4) Planning considerations
 - (5) Phases of compound search
 - (a) Establish ICP
 - (b) Isolation
 - (c) Approach and Entry
 - (d) Threat mitigation
 - (e) Systematic Search/Search Open area
- d. **METHODOLOGY:** This module will be introduced through the lecture method combined with

plenary discussions and Question and Answer (Q&A).

- e. **REFERENCES:** The following references are available to support this module:
 - (1) ANZCTC (2017). Improvised Explosive Device (IED) Guidelines for Crowded Places. Australia: Author
 - (2) Homeland Security: IED Search Procedures Overview. Retrieved from: https://na.eventscloud.com/file_uploads/2720d345f3a0ca6e71e173f07bed63ac_DH_SIEDSearchProcedures.pdf
 - (3) Multi-National Corps (2004). Improvised Explosive Devices, Smart Cards: ASOF27OCT2004. Iraq. Retrieved From: <https://info.publicintelligence.net/OIF-IED-SmartCard.pdf>
 - (4) UNMAS (2018). United Nations Improvised Explosive Device Disposal Standards. Document Reference no. 2018.05. New York. USA: Author
 - (5) USA Homeland Security (May 2012). Sports Venue Bag Search Procedures Guide Commercial Facilities Sector-Specific Agency: Author
 - (6) Homeland Security: Security and Resiliency Guide Counter-Improvised Explosive Device (C-IED) Annex for Lodging Stakeholders. Retrieved from:

https://www.cisa.gov/sites/default/files/publications/Security-and-Resiliency-Guide-Lodging-Annex_1.pdf

MOD 2.6: PARTICIPANT COMPOUND SEARCH PRACTICE

TIME ALLOCATED: 2x45 Periods

Objective:

To practically demonstrate and enhance the participants understanding of the process and mechanics of a compound search task.

Guidance:

The instructors will be required to practice and rehearse prior to the lesson. The Lead Instructor will require 7 role players. Selecting a suitable compound, the participants are to observe a complete task done at an increased speed by the role players. During the demo, the Lead Instructor is to narrate the processes and provide explanation of each activity. The demo must cover all the phases of the compound search. On completion of the demo, the search teams are to practice a compound search under the guidance of the instructor.

NB

The Lead Instructor is to ensure that the team is supplied with all necessary equipment to carry out a compound search. E.g. Ladders, detectors, wire feelers etc

Learning Outcome 3

PRACTICAL EXERCISES

35. MODULES 3.1 a – FINAL EXERCISES

- a. **TIME:** This module is allocated 52 x 45 periods.
- b. **EXERCISE OBJECTIVE:** At the end of this exercise participants will demonstrate key competencies on search operations.
- c. **EXERCISE TESTING POINTS:**
 - (1) Basic skill testing (8x45)
 - (a) Use of Handheld metal detector
 - (b) Confirmation drills
 - (c) IED indicators
 - (d) GSA
 - (2) Route search
 - (a) Practice 1 (8x45)
 - (b) Practice 2 (4x45)
 - (c) Test 1 (8x45)
 - (d) Test 2 (8x45)
 - (3) Area search
 - (a) Practice task 1 (4x45)
 - (b) Test 1 (4x45)

- (4) Compound Search
 - (a) Practice task 1 (4x45)
 - (b) Test 1 (4x45)

- d. **REFERENCES:** The following reference is available to support this module:
 - (1) Exercise booklet

36. MODULES 3.1 b – DEBRIEFING AND CLEANING EQUIPMENT / RETEST OF PARTICIPANTS

- a. **TIME:** This module is allocated 4 x 45 periods.
- b. **GUIDANCE:**
 - (1) While course participants will be conducting cleaning and return of stores equipment, individuals will be debriefed on their performance.
 - (2) Participants who did not pass basic skill tests will be given an opportunity for a retest.

NB: Participants who failed 2 or more of the test exercises will not be able to retest.

ALL ARMS SEARCH COURSE – WEEK 1					
TIME	Day 1	Day 2	Day 3	Day 4	Day 5
08:00 08:45	Course Registration	CIED Fundamentals Mod 1.2	Ground Sign Awareness (Mod 1.4)	<i>Recap</i>	Incident reporting Mod 1.6
08:50 09:35	Evaluation Brief	Forensic Awareness (Mod 1.2)	Ground Sign Awareness (Mod 1.4)	Basic Search Mod 2.2	Incident reporting Mod 1.6
09:40 10:25	Opening Ceremony	Introduction to IEDs (Mod 1.2)	Threat Assessment (Mod 1.5)	Basic Search Mod 2.2	Route Check Mod 2.4
10:25 – 10:40 COFFEE / TEA BREAK					
10:40 11:25	Global Emerging threats Mod 1.1	Introduction to IEDs (Mod 1.2)	Threat Assessment (Mod 1.5)	Basic Search Mod 2.2	Phases of route search Mod 2.4
11:30 12:15	Global Emerging threats Mod 1.1	Introduction to IEDs (Mod 1.2)	Threat Assessment (Mod 1.5)	Basic Search Mod 2.2	Phases of route search Mod 2.4
12:20 13:05	Introduction to Explosive hazards Mod 1.2	5/25's, VAs & VPS (Mod 1.3)	Threat Assessment – Model Exercise Mod 1.5	Gender Considerations in Search Operations (Mod 2.3)	Phases of route search Mod 2.4
13:05 - 14:00 LUNCH BREAK					
14:00 14:45	Introduction to Explosive hazards Mod 1.2	5/25's, VAs & VPS (Mod 1.3)	Introduction to Search (Mod 2.1)	Gender Considerations in Search Operations (Mod 2.3)	Support to IED/EOD Teams Mod 2.4
14:50 15:35	Introduction to Service Munitions Mod 1.2	5/25's, VAs & VPS (Mod 1.3)	Introduction to Search (Mod 2.1)	Gender Considerations in Search Operations (Mod 2.3)	Instructor Demonstration: Phases of route search Mod 2.4
15:35 – 16:05 COFFEE / TEA BREAK					
16:05 16:50	Introduction to Service Munitions Mod 1.2	Ground Sign Awareness (Mod 1.4)	Mod 2.1 Assets Demo	Gender Considerations in Search Operations (Mod 2.3)	Senior Instructor Disposal
16:50 17:35	Introduction to Service Munitions Mod 1.2	Ground Sign Awareness (Mod 1.4)	Senior Instructor Disposal		
	Meet and Greet Dinner	Dinner	Dinner	Dinner	Dinner

ALL ARMS SEARCH COURSE – WEEK 2

TIME	Day 6	Day 7	Day 8	Day 9	Day 10
08:00 08:30	Participants Practice - Route Search Mod 2.4	<i>Recap</i>	<i>Recap</i>	<i>Recap</i>	<i>Recap</i>
08:30 09:15	Participants Practice - Route Search Mod 2.4	Area Search Mod 2.5	Basic Skill Testing Mod 3.1	Route Search – Practice 1 Mod 3.1	Area Search - Practice Task 1 Mod 3.1
09:20 10:05	Participants Practice - Route Search Mod 2.4	Area Search Mod 2.5	Basic Skill Testing Mod 3.1	Route Search – Practice 1 Mod 3.1	Area Search - Practice Task 1 Mod 3.1
10:05 – 10:35 COFFEE / TEA BREAK					
10:35 11:20	Participants Practice - Route Search Mod 2.4	Area Search – Practical Demo Mod 2.5	Basic Skill Testing Mod 3.1	Route Search – Practice 1 Mod 3.1	Area Search - Practice Task 1 Mod 3.1
11:25 12:10	Search Techniques- Metal Detector Mod 2.4	Area Search – Practical Demo Mod 2.5	Basic Skill Testing Mod 3.1	Route Search – Practice 1 Mod 3.1	Compound Search – Practice Task 1 Mod 3.1
12:15 13:00	Search Techniques- Sweeping Mod 2.4	Compound Search Mod 2.6	Basic Skill Testing Mod 3.1	Route Search – Practice 1 Mod 3.1	Compound Search - Practice Task 1 Mod 3.1
13:00 - 14:00 LUNCH BREAK					
14:00 14:45	Search Techniques- Detection Lane 1 & 2 Mod 2.4	Compound Search Mod 2.6	Basic Skill Testing Mod 3.1	Route Search – Practice 1 Mod 3.1	Compound Search - Practice Task 1 Mod 3.1
14:50 15:35	Search Techniques- Detection Lane 1 & 2 Mod 2.4	Compound Search – Practical Demo Mod 2.6	Basic Skill Testing Mod 3.1	Route Search – Practice 1 Mod 3.1	Compound Search - Practice Task 1 Mod 3.1
15:35 – 16:05 COFFEE / TEA BREAK					
16:05 16:50	Search Techniques- Detection Lane 1 & 2 Mod 2.4	Compound Search – Practical Demo Mod 2.6	Basic Skill Testing Mod 3.1	Route Search – Practice 1 Mod 3.1	Compound Search - Practice Task 1 Mod 3.1
16:50 17:35	Search Techniques- Detection Lane 1 & 2 Mod 2.4	Wrap-up	Wrap-up	Wrap-up	Wrap-up
	Dinner	Dinner	Dinner	Dinner	Dinner

ALL ARMS SEARCH COURSE – WEEK 3

TIME	Day 11	Day 12	Day 13	Day 14	Day 15
08:00	Recap	Recap	Recap	Recap	Recap
08:30					
08:30	Route Search – Practice 2 Mod 3.1	Route Search – Test 1 Mod 3.1	Route Search – Test 2 Mod 3.1	Area Search Test Task 1 Mod 3.1	Syndicate Course Evaluation
09:15					
09:20	Route Search – Practice 2 Mod 3.1	Route Search – Test 1 Mod 3.1	Route Search – Test 2 Mod 3.1	Area Search Test Task 1 Mod 3.1	Course Wrap Up
10:05					
10:05 – 10:35 COFFEE / TEA BREAK					
10:35	Route Search – Practice 2 Mod 3.1	Route Search – Test 1 Mod 3.1	Route Search – Test 2 Mod 3.1	Area Search Test Task 1 Mod 3.1	Closing Ceremony
11:20					
11:25	Route Search – Practice 2 Mod 3.1	Route Search – Test 1 Mod 3.1	Route Search – Test 2 Mod 3.1	Area Search Test Task 1 Mod 3.1	Departures
12:10					
12:15	Area Search –Test Mod 3.1	Route Search – Test 1 Mod 3.1	Route Search – Test 2 Mod 3.1	Debrief and Cleaning of Equipment / Re-test Mod 3.1	Departures
13:00					
13:00 - 14:00 LUNCH BREAK					
14:00	Area Search –Test Mod 3.1	Route Search – Test 1 Mod 3.1	Route Search – Test 2 Mod 3.1	Debrief and Cleaning of Equipment / Re-test Mod 3.1	Departures
14:45					
14:50	Area Search –Test Mod 3.1	Route Search – Test 1 Mod 3.1	Route Search – Test 2 Mod 3.1	Debrief and Cleaning of Equipment / Re-test Mod 3.1	Departures
15:35					
15:35 – 16:05 COFFEE / TEA BREAK					
16:05	Area Search –Test Mod 3.1	Route Search – Test 1 Mod 3.1	Route Search – Test 2 Mod 3.1	Debrief and Cleaning of Equipment / Re-test Mod 3.1	Departures
16:50					
16:50	Wrap-up	Wrap-up	Wrap-up	<i>Wrap-up</i>	Departures
17:00					
	Dinner	Dinner	Dinner	Dinner	Dinner

ANNEX B

COURSE EVALUATION TEMPLATES

ALL ARMS SEARCH COURSE DAILY EVALUATION FORM TEMPLATE DAY 1

Instructions:

All participants will respond to questions contained in this form at the end of each day with guidance from the DS team. Participants are requested to rate each module covered by ticking (☐) against the preferred score. The scores include **5-Excellent; 4-Very Good; 3-Good; 2-Average, 1-Below Average**. In addition, the participant is asked to comment on the module's content, relevance, strengths, areas to improve as well as the facilitator's performance in delivery. Your honesty is highly appreciated.

Module	5	4	3	2	1	COMMENTS
1.1 Introduction to AU/UN Peace Operations						Strengths:
						Relevance:
						Facilitator's Performance:
						Areas for Improvement:
1.2 Explosive hazard Awareness						Strengths:
						Relevance:
						Facilitator's Performance:
						Areas for Improvement:

Thank you for participating!

ANNEX B

ALL ARMS SEARCH COURSE SYNDICATE/GROUP EVALUATION FORM TEMPLATE

Instructions:

To enable us to improve the course and achieve its overall objective, participants through their syndicates are requested to give their feedback. The syndicate members should discuss, agree and rate the course in terms of Course Expectations, Content, Facilitation, and Administrative Support. The rating shall stretch from **5-Excellent; 4-Very Good; 3-Good; 2-Average, 1-Below Average**. Additionally, please respond to the questions that follow. Your honesty is highly appreciated.

Course Expectations: Rate []

1. Please indicate what you expected to gain from this course (*Be as specific as possible*).
2. Were the course expectations met or not? (Please explain)
3. In your view, what should be done differently?

Course Content: Rate []

1. In your opinion, did the course achieve its objectives? (*Explain further*).
2. How will you utilise the knowledge gained in your work?
3. Where are the syndicate exercises helpful? (Please explain)

4. What changes in terms, of course, content/syndicate exercises that you would suggest to be made for subsequent courses?

Facilitation: Rate []

1. In your view, did the facilitation team meet your expectations?
2. Please comment on their:-
 - (a) Preparedness
 - (b) Grasp of subject matter
 - (c) Pace of instruction
 - (d) The effort to involve the class in discussions
 - (e) Others (*Specify*)

Administrative Support: Rate []

1. In terms of administrative support (technology, learning materials and facilities), did the training centre meet its objective? (*Please Explain*).
2. How can the training centre make its course administrative support better?
3. Would you encourage someone else to attend a course here? (*Please Explain*).

Thank you for participating!

ANNEX B

ALL ARMS SEARCH COURSE AFTER ACTION REVIEW CHECKLIST TEMPLATE

Ser.	Guiding Question	Observation	Recommendation	Action Addressee
	Design (primary responsibility-Curriculum Design)			
	Is the course content VALID from a strategic perspective? ¹			
	Did the Writing Board produce the desired output – Learning Plan?			
	Was a Learning Plan produced in sufficient detail to permit a training platform to develop the training material and courseware?			
	Did the Learning Plan specify desired Instructor/facilitator profiles?			
	Was the Design phase conducted within budget parameters?			
	Development (Primary responsibility-Training Institution in conjunction with Curriculum Design)			
	Does the courseware conform to the Training Delivery Guidelines?			
	Did the Courseware produced conform to the Learning Plan – Operational Validation?			
	Did the training timetable conform to the Learning Plan – Operational validation?			
	Were potential instructors/facilitators identified by (IAW) the Learning Plan profiles?			

¹ Strategic Validation is the process by which the content is compared and contrasted against known and acceptable recognized standards.

ANNEX B

	Delivery (Primary responsibility-EOD/IEDD School/Training Facility)			
	Were the instructors/facilitators appropriately knowledgeable about the subject matter?			
	Were the instructors/facilitators appropriately prepared to deliver training IAW Terms of Reference (TOR) and contractual agreements?			
	Was the training timetable adhered to?			
	Was there appropriate EOD/IEDD School/Training Facility representation at the Opening & Closing Ceremonies?			
	Were all necessary protocols observed?			
	Did the contracted staff (i.e. Lead Facilitator) perform their task IAW TOR and contractual obligations?			
	Was the Evaluation Plan executed with individuals receiving feedback?			
	Was training delivered IAW EOD/IEDD School/Training Facility Training Delivery Guidelines?			
	Was the course conducted within budget parameters?			
	Were course preparations complete on time IAW the EOD/IEDD School/Training Facility Planning & Conduct Guidelines?			
	Did the Directing Staff (DS) perform their tasks/functions IAW the EOD/IEDD School/Training Facility Planning & Conduct Guidelines and specified TOR?			
	Were the students nominated appropriate for the level and substance of the course?			
	Were the students satisfied with the course from a content perspective?			
	Were the students satisfied with the course from a training delivery perspective?			

ANNEX B

	Training Support (Primary responsibility - EOD/IEDD School/Training Facility)			
	<p>Was support rendered by the EOD/IEDD School/Training Facility sufficient and of an acceptable standard to permit the smooth conduct of a course and did not detract from the learning experience?</p> <ul style="list-style-type: none"> ● Accommodation ● Transport ● Rations ● IT 			
	<p>Were all training support issues conducted IAW the mutually agreed (sponsor & EOD/IEDD School/Training Facility) to Training Support Checklist and within the budget?</p>			
	<p>Were end-course activities organized and executed in sufficient time to permit the desired output, i.e.</p> <ul style="list-style-type: none"> ● Plaque coordinated and ordered on time ● Course photographs ● Certificates produced on time to permit appropriate level signature (s) ● Flash drives/CDs/DVDs 			
	Administration (Primary responsibility- EOD/IEDD School/Training Facility)			
	<p>Was the budget reconciled in time and with all necessary supporting documentation to permit timely reimbursement to the appropriate HQ?</p>			
	<p>Was the EOD/IEDD School/Training Facility courseware uploaded to the common drive for historical purposes? Was a backup CD given to the library?</p>			

ANNEX B

**ALL ARMS SEARCH COURSE
FOLLOW-ON EVALUATION SURVEY (3-6 months after the course)**

1. Has the course enhanced your knowledge and understanding of All Arms Search?

Strongly Disagree	Disagree	Neither Disagree Nor Agree	Agree	Strongly Agree
<input type="radio"/>	<input type="radio"/>	<input type="radio"/>	<input type="radio"/>	<input type="radio"/>
Theory/Lecture	Syndicate Activity/ Video	Re		
Any comment?				

2. To what extent have you applied the skills learned?

very little	little	neutral	much	very much
<input type="radio"/>	<input type="radio"/>	<input checked="" type="radio"/>	<input type="radio"/>	<input type="radio"/>

3. How did the course impact your job performance?

very little	little	Neutral	much	very much
<input type="radio"/>	<input type="radio"/>	<input type="radio"/>	<input type="radio"/>	<input type="radio"/>

4. How did the course impact your ability to share your opinion on Search in the field/PSO Environment?

very little	little	Neutral	much	very much
<input type="radio"/>	<input type="radio"/>	<input type="radio"/>	<input type="radio"/>	<input type="radio"/>

ANNEX C

PARTICIPANT COURSE REPORT

PART 1 – COURSE INFORMATION

COURSE TITLE: ALL ARMS SEARCH COURSE

Course ID	Code/Serial	Start Date	End Date	No of Days	Language
AASC	-	-	-	5	English
Participant	Rank	Component	Country		

Introduction

1. Explosive hazards (ERWs, Landmines and IEDs) are security realities that mission personnel, humanitarian workers and the civilian population have to deal with on a day to day basis. This is because, even after the war has ended, explosive hazards that have been left behind can stay on the land for years hence impacting the livelihoods of people since they cannot till their lands or go about with their normal business.

2. Further to this, explosive hazards have continued to cause devastating impacts to mission environments, therefore, affecting communities in their recovery and reconstruction efforts. It is in this regard that the All Arms Search Course was created to build capacity for troops and police earmarked for deployment and those already deployed. The course will do this by enhancing the knowledge and skills of TCCs and PCCs on basic search capabilities required in mission environments.

Course Aim

To enhance the knowledge and skills for effective search procedures, to increase operational effectiveness in an IED threat environment.

Training Need

The extant security threats have continuously compromised the successful operation in peace missions. Search is a capability that can be used across all operating environments by assisting TCCs and PCCs in locating specific targets by the use of intelligence assessment, systematic procedures and appropriate detection techniques.

Methodology

This course is structured such that there are theoretical lessons followed by practical sessions. The lecture portion of the course will be delivered in standard "lecture" format. However, this type of methodology will be used in a limited fashion. Whenever possible, practical approaches to learning will be used (for example, Problem Based Learning) and each of the learning outcomes will be reinforced with a practical session which will include but not be limited to role plays, syndicate exercises, case studies, and simulations.

ANNEX C

Learning Outcomes

The course had Three (3) Learning Outcomes as follows:

- a. Understanding the operating environment. Enhance the participants' knowledge of the conventional operating environment, how it is impacted by explosive hazards and develop skills to mitigate the IED threat.
- b. Search Operations. Develop practical skills to conduct the full spectrum of intermediate search capability.
- c. Practical Exercises and Tests. Apply lessons learnt to demonstrate a sufficiently high standard to deploy on operations in an IED threat environment.

PART 2 – PARTICIPANT ASSESSMENT

Assessment/Recommendation:

The following assessment categories will be applied:

.....was a very active participant in both Syndicate and Plenary discussions of the AASC Course. He/She demonstrated a solid grasp of the All Arms Search Course concepts and demonstrated a keen interest in the training.

.....is recommended as a facilitator for future serials of the All Arms Search Course.

Director
Training Centre

(Indicate Date)

ANNEX D

SEARCH REPORT MILITARY

Operation:	Serial:
------------	---------

Section A – Pre Task Information

A.1 – Target Details

Type:	Route:		Area:		Building:		Other:	
Description:								
Address					GR (Centre or Start)			
					GR (Finish)			
	Nearest Town:				Length or Route			

A.2 – Authority to Search

Authorising Officer	Name:	Rank:	Appt:	Sign:	Date:
Details of authority to search:					

A.3 – Task Details

Tasked Unit:				HQ Unit:			
				Task AOR:			
Incident Comd:	Name:	Rank:	Unit:	Contact:			
Search Adv:	Name:	Rank:	Unit:	Contact:			
Police:	Name:	Rank:	Unit:	Contact:			
IEDD Op:	Name:	Rank:	Unit:	Contact:			
ECM Adv:	Name:	Rank:	Unit:	Contact:			
Search Teams:	Team Comd:	Rank:	Unit:	Contact:			
	Team Comd:	Rank:	Unit:	Contact:			

ANNEX D

B.4 – Vehicles Present

Ser	Make	Model	Colour	VRN	Owner	Engine No	Comments
1							
2							

B.5 – Authorised Weapons

Ser	Type of Weapon	Serial Number	Certificate Number	Ammo Held	Owner	Comments
1						
2						

B.6 – Search Log

Ser	Date / Time	Event	Action Taken
1			
2			
3			
4			
5			
6			
7			
8			
9			
10			
11			
12			
13			
14			
15			
16			
17			
18			
19			
20			
21			
22			
23			
24			
25			
26			
27			
28			
29			
30			

Number:	Rank:	Name:	Unit:	Sign:
The above-mentioned person handed this report to the below-mentioned person.				
Number:	Rank:	Name:	Unit:	Sign:

ANNEX E

GLOSSARY OF TERMS AND CONCEPTS

Abandoned Explosive Ordnance (AXO): Conventional EO that has not been used during an armed conflict, that has been left behind or dumped by a party to an armed conflict, and which is no longer under control of the party that left it behind or dumped it. AXO may or may not have been primed, fuzed, armed or otherwise prepared for use.

Area Level IED Threat Assessment: The processes of an IEDD organization examining the IED threat for a given geographical area under their responsibility in line with the terms of reference provided to them by the designated IEDD authority. Area level IED threat assessment is informed from the regional IED threat picture produced by the national level IED threat assessment as well as scene level IED incident reports. Area level IED threat assessments produce incident briefing packs & local threat picture products for IEDD teams they control and provide area IED analysis products to the national IEDD threat assessment.

Area of Operations (AO): An area of operations refers to a geographical space on the earth that is defined by a designated IEDD authority to be under the responsibility of a stated IEDD Organization for IEDD activities therein.

Assets: A term referring to equipment, vehicles, buildings or materiel.

Capability: The ability of an organization or entity to achieve a stated ability from the collective contribution of assets and the competence to safely, effectively and efficiently operate them.

Conflict: The expressed struggle between at least two interdependent parties who perceive incompatible goals, scarce resources, and interference from others in achieving their goals.

Delivery Method: An IED incident should be characterized if the IED was to be delivered by some means to its intended target. i.e. It is a non-static IED. Such delivery methods include Vehicle Borne (VB); Animal borne; Waterborne; Airborne; Person – proxy or suicide; Projected – Indirect/direct.

Demining / Humanitarian Demining: Activities that lead to the removal of mine and ERW hazards, including technical survey, mapping, clearance, marking, post-clearance documentation, community mine action liaison and the handover of cleared land. Demining may be carried out by different types of organizations, such as NGOs, commercial companies, national mine action teams or military units. Demining may be emergency-based or developmental.

- (a) Mine and ERW Clearance is considered to be just one part of the demining process;
- (b) Demining is considered to be one component of my action
- (c) The terms demining and humanitarian demining are interchangeable

Detection Procedures: Those actions taken by any means to discover the presence of an item or substance of potential EO significance.

Device Orientation: When an IED is emplaced to specifically attack some part of a target e.g. underside/side/top, the device orientation should be characterized appropriately. When an IED

ANNEX E

intended purpose is anti-personnel, it is typical not to include device orientation in its tactical characterization.

Diagnostic Procedures: A collective term used in EOD that refers to both identification and evaluation procedures.

Do No Harm Approach: The approach to be taken in all aspects of the design and delivery of an IED RE program, relating to unintended consequences as a result of the delivery of such a program, which include:

- (a) Exposing the local populace to being harmed
- (b) Educating those who intend to do harm
- (c) Spreading the production and use of IEDs
- (d) Increasing unnecessary fears
- (e) Promoting civilians to 'clear' IEDs themselves.

Electronic Counter-Measures (ECM): The equipment, techniques and specialists within IEDD to temporarily inhibit or mitigate the threat posed by RCIEDs.

Emplacement Location: When statically employed IED emplacement should be characterized as Subsurface, Surface or Elevated.

Environmental Factors: In area evaluation, terrain, vegetation, weather, altitude, access and other local physical and meteorological influences need to be considered in how they can impact an EOD incident.

EOD Procedures: The collective term refers to the following procedures, intended to result in the final elimination of an item of explosive ordnance; detection; location⁸⁷, access,

identification, evaluation, hazard mitigation, rendering safe, component recording and recovery and final disposal.

Evaluation Procedures: Those actions taken to analyze the results obtained from EOD identification procedures to assess the likely mode of action it's and associated hazards along with those in the locality.

Explosion: A type of IED incident in which involves the uncontrolled initiation or functioning of an IED. This type of incident also includes a partial explosion termed 'a partial' were only a part of the explosive train has functioned, in which case it should be expected that varying amounts of explosive or potentially dangerous items will be in situ.

Explosive Hazard: An explosive hazard is any hazard containing an explosive component. All explosive hazards encountered can be broken down into the categories: Mines, ERW, IEDs and components and precursor chemicals thereof.

Explosive Ordnance (EO): All munitions containing explosives, nuclear fission or fusion materials and biological and chemical agents. This includes bombs and warheads; guided and ballistic missiles; artillery, mortar, rocket and small arms ammunition; all mines, torpedoes and depth charges; pyrotechnics; clusters and dispensers; cartridge and propellant actuated devices; electro-explosive devices; clandestine and improvised explosive devices (IEDs); and all similar or related items or components explosive in nature.

Explosive Ordnance Disposal (EOD): The term EOD is a collective one that includes the procedures of detection, location, access, identification, evaluation, hazard mitigation, render safe, recording and recovery and final disposal used in the disposal of

ANNEX E

items of Explosive Ordnance (EO) or any hazardous material associated with an EOD incident.

Explosive Remnants of War (ERW): Refers to Unexploded Ordnance (UXO) and Abandoned Explosive Ordnance (AXO).

External IEDD Support: Refers to support which is non-organic to the IEDD team and needs to be provided from other elements. This support typically includes communications, medical, security, transport, search, ECM assets and situational awareness support.

False: An IED related incident that is incorrectly identified though reported in good faith as an IED, which is subsequently categorized as a false alarm after positive Explosive Ordnance Disposal (EOD) action.

Final Disposal: The action of elimination (destruction) of explosive ordnance hazards by EOD personnel. Final disposal may be achieved as part of the rendering safe of an item or EO or be separate actions taken after it has been rendered safe.

Find / Cache: An IED related incident that involves the discovery and/or recovery of an IED not yet emplaced or employed, IED components, and/or IED paraphernalia.

Gender Analysis: Gender analysis is a systematic way of looking at the different impacts of development, policies, programs and legislation on women and men that entails, first and foremost, collecting sex-disaggregated data and gender-sensitive information about the population concerned. Gender analysis can also include the examination of the multiple ways in which women and men, as social actors, engage in strategies to transform existing roles, relationships, and processes in their interest and the interest of others.

Gender Equality: Gender equality entails the concept that all human beings, both men and women, are free to develop their abilities and make choices without the limitations set by stereotypes, rigid gender roles, or prejudices. Gender equality means that the different behaviours, aspirations and needs of women and men are considered, valued and favoured equally. It does not mean that women and men have to become the same, but that their rights, responsibilities and opportunities will not depend on whether they are born male or female.

Gender Equity: Gender equity means fairness of treatment for women and men, according to their respective needs. This may include equal treatment or treatment that is different but considered equivalent in terms of rights, benefits, obligations and opportunities. In the development context, a gender equity goal often requires built-in measures to compensate for the historical and social disadvantages of women.

Gender Mainstreaming: Gender mainstreaming is the process of assessing the implications for women and men of any planned action, including legislation, policies or programmes, in any area and at all levels. It is a strategy for making women's as well as men's concerns and experiences an integral dimension in the design, implementation, monitoring and evaluation of policies and programmes in all political, economic and social spheres, such that inequality between men and women is not perpetuated.

Gender Neutral: Do not reinforce existing gender inequalities.

Gender-Sensitive: Attempt to redress existing gender inequalities.

Gender Transformation: Attempt to re-define women and men's gender roles and relations.

ANNEX E

Gender: Gender refers to the array of socially constructed roles and relationships, personality traits, attitudes, behaviours, values, relative power and Individuals following the letter and spirit of human rights, refugee and international humanitarian law. Protection involves creating an environment conducive to respect for human beings, preventing and/or alleviating the immediate effects of a specific pattern of abuse, and restoring dignified conditions of life through reparation, restitution and rehabilitation/ preservation from injury or harm.

Hazard Mitigation Procedures: Application of control measures intended to reduce the likelihood of the initiation of an item of EO and/or the consequences of such an initiation.

Hoax: An IED related incident that involves a device fabricated to look like an IED and that is intended to stimulate one to elicit a response.

Human Rights: The universal, indivisible, equitable, and indispensable claims and entitlements that are endowed to all persons simply for the sake of being human.

Human security: “Human security can be said to have two main aspects. First, it means, safety from chronic threats such as hunger, disease and repression. And second, it is the protection from sudden and hurtful disruptions in the patterns of daily life whether in homes, in jobs or communities. Such threats can exist at all levels of national income and development. (UNDP)

Identification Procedures: Those actions taken to establish the make-up and characteristics of an item of EO.

IED Aggressor: Any person or group of persons or organization that has the intent and/or capacity to inflict or threaten physical violence through the use or threatened use of IEDs.

IED Awareness: A comprehensive set of IED theory presentations and practical lessons, which may include written and or practical assessments, with the intent to provide or increase the knowledge of recipients concerning IEDs, their threat and basic threat mitigation measures.

IED Clearance: Clearance of IEDs refers to tasks or actions to ensure the removal and/or the destruction of all IED hazards from a specified area to an agreed standard.

IED Disposal (IEDD): The collective term referring to the following EOD procedures, intended to result in the final elimination of an IED; detection, location, access, identification, evaluation, hazard mitigation, rendering safe, component recording and recovery and final disposal.

IED Incident Response: Procedures to ensure the removal and/or destruction of all IEDs and associated hazards which are located or detected not as part of an ongoing planned IEDD operation but is reported or turned in by another party after their discovery. IED incident response can only be undertaken by advanced IEDD teams and may be conducted in all types of operating environments including non-permissive environments as part of emergency based IEDD.

IED Related Incidents: An event that involves one or more of the following IED-related actions/activities: IED, Explosion, Find / Cache, Turn-In, Hoax, or False.

IED Risk Education: Activities that seek to reduce the risk of injury and casualties from IED by raising awareness of men, women and children following their different vulnerabilities, roles and needs, and promoting behavioural change including public information dissemination, education and training, and community IEDD liaison.

ANNEX E

IED Threat Assessment: The processes of examining the IED threat for a given IED threat environment and determining the most appropriate IEDD capability that is required to address the assessed threat.

IED Threat Environment: A geographical designation, in which there is the confirmed or assessed presence of IEDs.

IED Threat Mitigation (IED-TM): A whole of UN approach which focuses on the application of physical, procedural and training responses that can collectively be applied to mitigate the threats posed and consequences of IED attacks.

IED Threat Picture: An assessment of the potential use of IEDs in a defined geographical area by a stated IED aggressor or aggressor(s) against a stated entity in terms of the technical complexity and tactical sophistication along with the aggressor(s) intent, capabilities and opportunities along with local factors.

IEDD Clearance Plan: An IEDD clearance plan is the product of an incident appreciation in which safe, effective and efficient courses of action involving EOD procedures are developed in line with the assessed EO threat. All IEDD plans should have three COAs with a priority given to their execution and be mutually supporting in that if the first COA is unsuccessful the second can be used and so on until the IED is disposed of. The plan should consider: what is the most dangerous outcome, the best outcome and the most likely outcome and mitigate the associated hazards of each appropriately. All IEDD Plans must be in line with the IEDD philosophy and principles.

IEDD Organization: The entity that is permitted by the designated IEDD authority to undertake IEDD in line with agreed

terms of reference written in line with the contents of the IEDD standards.

IEDD Planning: IEDD planning refers to the processes of examining the IED threat for a given IED threat environment and determining the most appropriate IEDD capability that is required to address or mitigate the assessed threat. IEDD planning takes place on three levels of National Level, Area Level and Scene Level.

IEDD Protective Equipment: Garments and equipment designed to protect an IEDD operator from the blast, fragmentation and thermal effects resulting from the unintentional initiation of an IED or another item of explosive ordnance.

IEDD Staff: Qualified IEDD personnel with appropriate technical experience and competencies coupled with the appropriate managerial skills to advise or lead UN Staff, designated IEDD authority and IEDD organizations involved in IEDD. It is the responsibility of the designated IEDD authority to determine what is suitable and accepted as an experience.

Improvised Explosive Device: A device placed or fabricated in an improvised manner incorporating destructive, lethal, noxious, pyrotechnic, or incendiary chemicals and designed to destroy, incapacitate, harass, or distract. It may incorporate military stores, but is normally devised from non-military components.

Improvised: In the context of EOD, improvised is taken to refer to the design, construction and or placement of an item of EO or component thereof. Such items of EO or components thereof are made from materials available at hand and have one or more of the following characteristics:

- (a) Not subject to quality control

ANNEX E

- (b) Use components not in their original use
- (c) Employed in a manner that was not intended in its design

Information Management: The term 'Information Management' refers to the ongoing specification of information requirements, its collection and analysis followed by the dissemination of relevant information to relevant stakeholders promptly.

Infrastructure and Urban Space IED Clearance: Procedures to ensure the removal and/or destruction of all IEDs and associated hazards from buildings, structures, facilities and their immediate surrounding spaces. Building and infrastructure IED clearance is not conducted in non-permissive operating environments. It may be conducted in permissive operating environments as part of developmental based IEDD or in semi-permissive operating environments as part of emergency based IEDD and is only undertaken by intermediate or advanced IEDD teams.

Intent: The desired aim or purpose that an act is carried out with through prior thought and planning.

Lessons Learned: People, things and activities related to the act of learning from experience to achieve improvements

Local Environmental Factors: The local environmental factors within area evaluation, refer to terrain, infrastructure, vegetation, weather, altitude, access and other local physical and meteorological influences that need to be considered in how they can impact an IED incident.

Local Factors: Those environmental and macro-level factors that are identified as a result of an area evaluation undertaken as part of an EOD incident appreciation.

Location Procedures: Those actions within the EOD task result in determining the presence and position of an item or EO.

Macro-Level Factors: In area evaluation, higher-level local influences need to be considered and how they can impact an IED incident. They set the incident in context with regards to the background situation and make an appreciation of how such factors can also influence potential threats. Typical macro-level factors include a socio-economic picture, political and security context, factions/groups, culture and ongoing and recent IED activity.

Manual Actions: Steps carried out by an EOD operator in person as part of EOD procedures near an item of EO or suspect item.

Manual Approach: An approach by an EOD operator into the estimated danger area circumference of an item of EO or suspect object, before or after neutralization.

Mobility Protection IEDD: Mobility protection IEDD refers to procedures to ensure the clearance of all IEDs and associated hazards obstructing the movement through or past a given location or area. Mobility protection IEDD can only be undertaken by advanced IEDD teams and may be conducted in all types of operating environments including non-permissive environments.

Modus Operandi: Method of operation; style of handling things.

National Level IED Threat Assessment: The processes of the designated IEDD authority examining the IED threat for the geographical area under their responsibility to determine the national IED threat picture and associated IEDD capabilities required by the IEDD organizations they will deploy to designated areas of responsibility. The national threat picture is

ANNEX E

informed by all source IED information fusion and the provision of IED analysis products by IEDD organizations under its control.

National Level IEDD Planning: Higher level planning to assess the present and potential future explosive hazard threats in a given country including in the wider region.

One Person Risk: A principle that requires that only one operator is within the assessed danger area of an IED during any part of a render safe procedure.

Open Area IED Clearance: Procedures to ensure the removal and/or destruction of all IEDs and associated hazards from a specified area to an agreed standard.

Opportunity: The assessment of the chances of a set of circumstances that makes it possible for an aggressor to carry out an attack.

Other Devices: Manually-emplaced munitions and devices including improvised explosive devices designed to kill, injure or damage and which are actuated manually, by remote control or automatically after a lapse of time.

Positive EOD Action: Any action taken during an EOD task that has the potential to influence or alter the state of the firing switch or mechanism of an item of explosive ordnance.

Projected IED: IEDs involving improvised projected mortars, rocket-assisted mortars and free-flight rockets.

Protection: Protection is understood as all measures and means employed to minimize the vulnerability of personnel, facilities, equipment during operations posed by any threat and in all situations, to preserve freedom of action and operational effectiveness.

Rape: A sexual assault involving some type of penetration (i.e., vaginal, oral, or anal) due to force or threat of force; lack of consent; or inability of the victim to provide consent due to age, intoxication, or mental status/ is forced, manipulated, or coerced sexual contact by a stranger, friend or acquaintance.

Recording and Recovery Procedures: Those actions taken to document and retrieve items of EO or components thereof that are in an acceptable state of safety. These procedures include the reporting of EOD incidents.

Remote Actions: Remote actions are those that can be carried out without the need for the operator to approach or be near the IED. The use of an ROV fitted with injectors is an example of a remote action.

Remote Control: Control by commands from a distance.

Risk: Combination of the probability of occurrence of harm and the severity of that harm.

Risk Analysis: A process that evaluates the likelihood of the assessed threat impacting an organization and the severity of the consequences of those threats.

Safe Waiting Periods: Safe waiting periods are waiting times which an EOD operator must allow to elapse, before making a manual approach. The times are mandatory and cover both the primary and secondary safe waiting periods. Note: the term soak time is used in some EOD communities to refer to safe waiting periods.

Safe, Effective and Efficient: The characteristics that all IEDD capabilities should have at all times in that the associated risk is assessed as tolerable, it achieves the desired outcome or end

ANNEX E

state within an acceptable time, financial, personnel and other resource constraints.

Scene Level IEDD Planning: Scene level IEDD planning is the planning associated with individual IEDD tasks which are typically bounded in terms of space or time. It can involve pre-planned tasks in the case of IED area clearance or urban space and infrastructure clearance, or it can involve dynamic planning as in the case of mobility protection or IED incident response. Scene level planning is informed by area-level planning, and it, in turn, informs area level planning through IED incidents reports.

Scene Threat Assessment: An assessment of an IED task from information gathered through observation, map analysis, witnesses, surveys and all other means allowing an area evaluation in support of a threat assessment leading to threat integration from which possible courses of action are identified as part of a safe, effective and efficient IEDD plan.

Secondary Hazards: Secondary hazards are other hazards present at the scene of an EOD task which is not directly a consequence of the EO item but a hazard due to its proximity to the EO item within the danger area of the EO item. Examples of secondary hazards include fuel sources, dangerous chemical or radiological substances, electrical supplies, glass-fronted buildings, unstable buildings, rubble or other ground as well as biological hazards.

Security: The ability of a nation to protect its internal values from external threats, which are frequently transformed into interstate conflicts due to their spillover effects into the neighbouring countries/ absence of a threat/ safety of a state.

Semi-remote Actions: Steps carried out by an EOD operator requiring an approach into the estimated danger area circumference of an item of EO or suspect object to place or fit a weapon or tool. The tool or weapon is then operated remotely.

Sex: Sex refers to the biological characteristics which define humans as female or male.

Sexual Abuse: Actual or threatened physical intrusion of a sexual nature, including inappropriate touching, by force or under unequal or coercive conditions.

Sexual Assault: The full range of forced sexual acts, including forced touching or kissing; verbally coerced intercourse; and vaginal, oral, and anal penetration.

Sourcing: The process of determining the origination point (such as a production facility or person, a geographic location, or a specific country of origin) for IED components.

Strategic Gender Interests: Strategic Gender Interests (SGIs) are identified by women as a result of their subordinate social status, and tend to challenge gender divisions of labour-power and control, and traditionally defined norms and roles. SGIs vary according to particular contexts and may include such issues as legal rights, domestic violence, equal wages, and women's control over their bodies.

Support to Prosecution: The process of associating related people, places, devices, or equipment to an individual for evidentiary purposes in a recognized court of law.

Tactical Characterization: How an IED incident is planned and conducted (tactical design) and the intent (purpose of the device).

ANNEX E

Threat Assessment: Evaluation of the likely intent and capabilities of an aggressor along with local factors, involved or potentially involved in an EOD incident.

Threat Integration: The process of combining aggressor intent and aggressor capability with local factors to identify those areas and activities that, when observed, will confirm or deny the aggressor's likely chosen course of action. This will inform the IEDD operator of critical points and weaknesses within the situation or incident that may be exploited for use in developing a safe, effective and efficient COAs to deny the aggressor of their intent.

Turn-In: An IED related incident where an IED or component is turned over to the proper authority.

Unexploded Explosive Ordnance (UXO): EO that has been primed, fuzed, armed or otherwise prepared for use or used. It may have been fired, dropped, launched or projected yet remains unexploded either through malfunction or design or for any other reason.

Victim Operated IED (VOIED): An IED with a firing switch that is activated by the actions of an unsuspecting individual, relying on the victim to carry out some form of action that will cause it to function.

Violence: The intentional use of physical force or power, threatened or actual, against oneself, another person, or against a group or community, that either result in or has a high likelihood of resulting in injury, death, psychological harm, mal-development, or deprivation/ aggressive behaviour, which may be physically, sexually or emotionally abusive.

Vulnerable Area (VA): Areas where the ground lends itself to IED or small arms light weapons attack.

Vulnerable Point (VP): Specific points where it is particularly advantageous for an aggressor to position an ambush, using either IEDs, SALW, or both. VP are typically characterized by prominent or restrictive feature or choke point on the ground. Several factors pertaining to aggressor capability, intent and local factor use will contribute to the vulnerability of a specific point.



All Arms Search Course



Content

- Module 1.1 Global emerging threats
- Module 1.2 Explosive hazard awareness, threats and ERWs
- Module 1.3 5- and 25-Meter checks, Vulnerable Points, areas and CAGE CMSA
- Module 1.4 Ground Sign Awareness
- Module 1.5 Threat Assessment
- Module 1.6 Incident Reporting
- Module 2.1 Introduction to Search
- Module 2.2 Basic Search
- Module 2.3 Gender Considerations in Search Operations
- Module 2.4 Introduction to Route Search
- Module 2.5 Introduction to Area Search
- Module 2.6 Introduction to Compound Search
- Module 3.1 Practical Exercises



All Arms Search Course (AASC)

Module 1.1 Global IED Threat



Ground Rules

- Time
- Safety
- Questions
- Notes
- Phones/Devices
- Food/Drink
- Previous knowledge
- Assessment



Module Objective

At the end of this module, participants will be able to explain the IEDs threat in relation to the global terrorism threats



Teaching Points Covered

- General history of IEDs
- Why terrorists use IEDs
- IED threat picture
- Emerging terrorists' threats
- Global and Regional perspectives
- Responses to IED threats



General History of IEDs

While the IED is sometimes described as a new technology, it has a lengthy history.

Ships loaded with explosives were used as far back as the 1500s



General History of IEDs



An assassination attempt using a vehicle bomb on Napoleon Bonaparte, 1800.



General History of IEDs Contd..

Another early example of coordinated large scale use of IEDs was the Belarusian Rail War launched by Belarusian guerrillas against the Germans during World War II.

Political developments in the 1800's were also a key element in the increased utilisation of IEDs



General History of IEDs Contd..

Both command-detonated and delayed-fuse IEDs were used to derail thousands of German trains in 1943–1944.





General History of IEDs Contd..

The 20th century saw another rise in the use of IEDs, not only by non-state actors and revolutionary or militia groups as well by the military



Why Terrorists Use IEDs

From teddy bears
to bombs:

The IEDs of ISIS





Why Terrorists Use IEDs

IEDs have been an increasingly common feature in conflicts around the world

Break into four groups, discuss and present in plenary the following question, you should use online sources to gather information. You have 10 minutes to research and prepare a simple list to explain to the class, you should welcome questions from the other groups.

What are some of the reasons that IEDs have become a weapon of choice for terrorists?



Why Terrorists Use IEDs

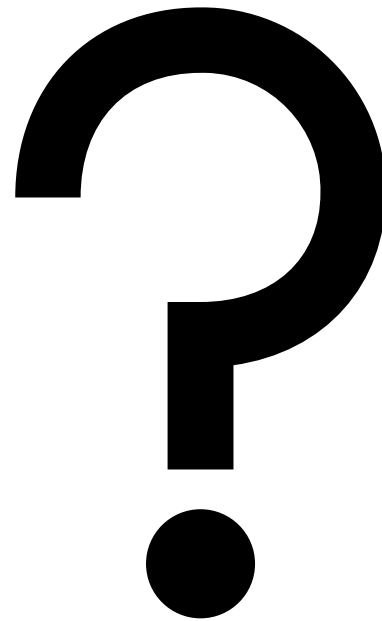



Emerging Global Terrorist Threats

Annually, IED attacks kill and injure more people than do attacks with any other type of weapon except firearms.

Proliferation of IED use is an unmistakable trend. About half of the world's countries have currently been impacted by IEDs



Emerging Global Terrorist Threats

The worldwide use of IEDs by terrorists has increased over time. There is no day that goes past without the impact of an improvised explosive device (IED) making headlines around the world.



Responses to IED threats

An ideal approach to defeating the IED threat would include a set of integrated efforts aimed at squeezing the adversary at each stage of the IED threat chain



Around the World - Afghanistan





Around the World - Egypt





Around the World – India





Around the World – Iraq





Around the World – UK and ROI





Around the World – Israel / Lebanon





Around the World – Libya





Around the World – Libya





Around the World – Nigeria





Around the World – Pakistan





Around the World – Russia





Around the World – Syria





Around the World – USA





Around the World – Ukraine





Around the World – Vietnam





Around the World – Yemen





Pillars of defeating IED

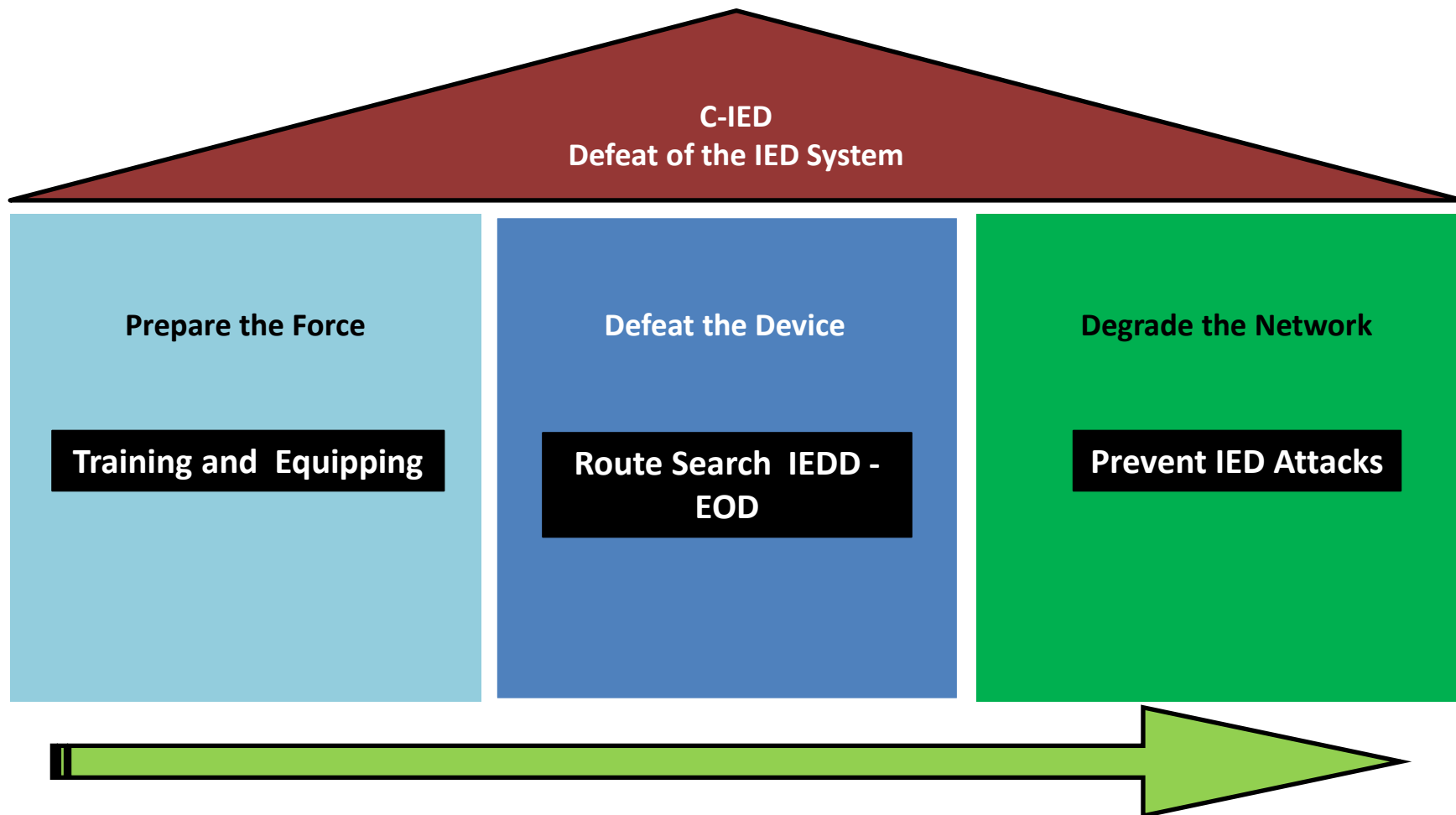



Worldwide IED Threat Map

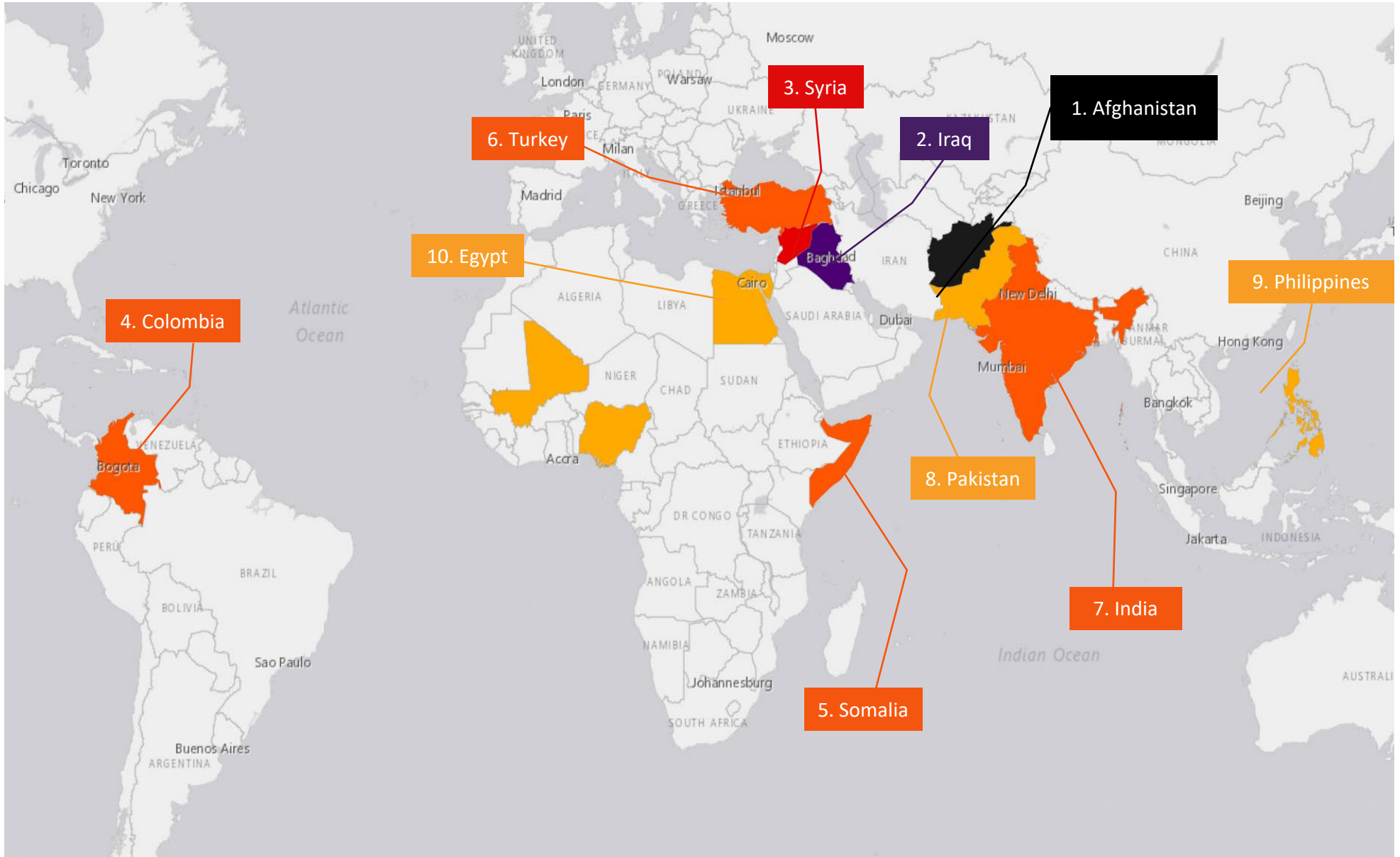



Africa IED Threat Map

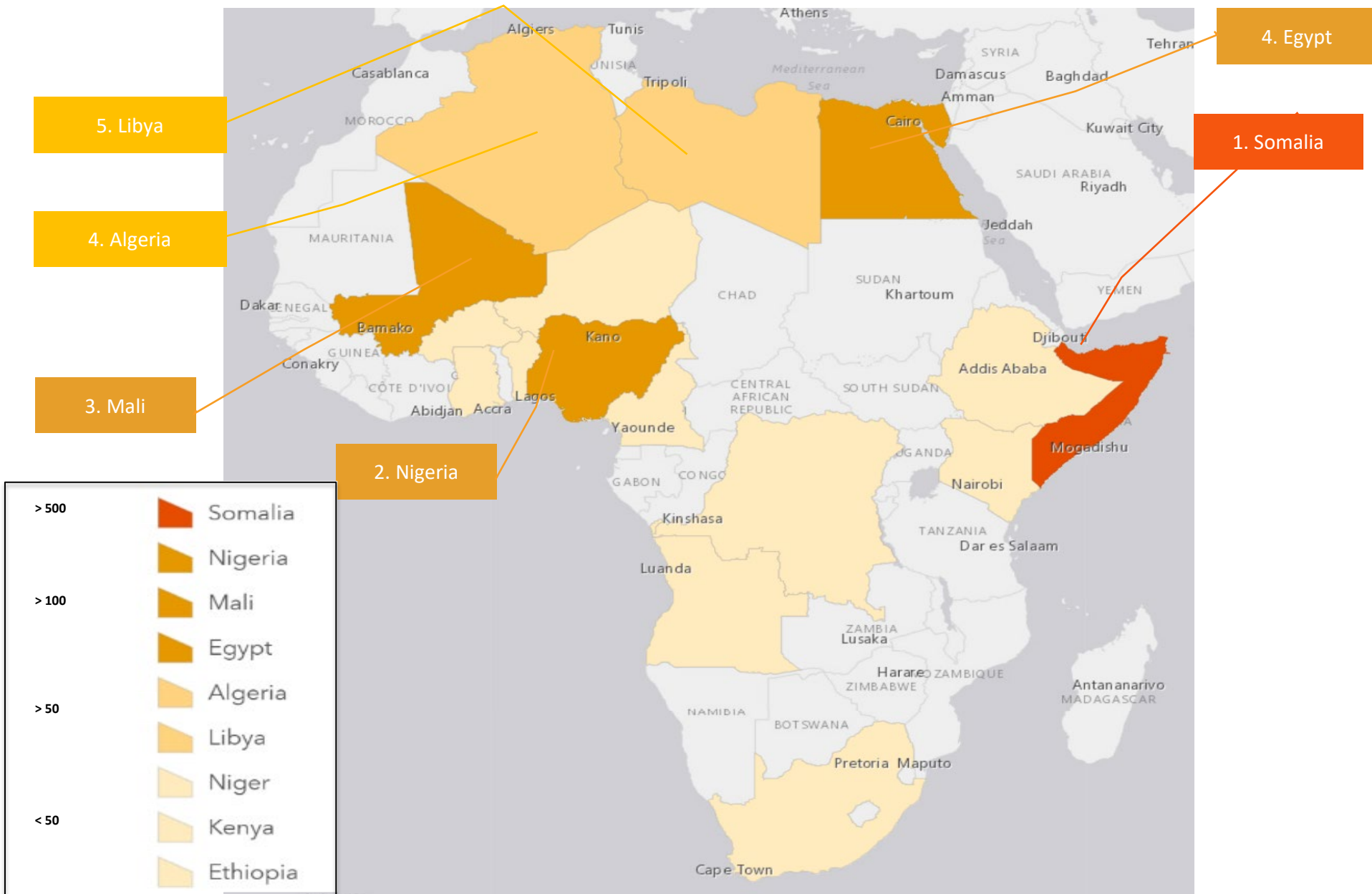



Africa IED and Battle data

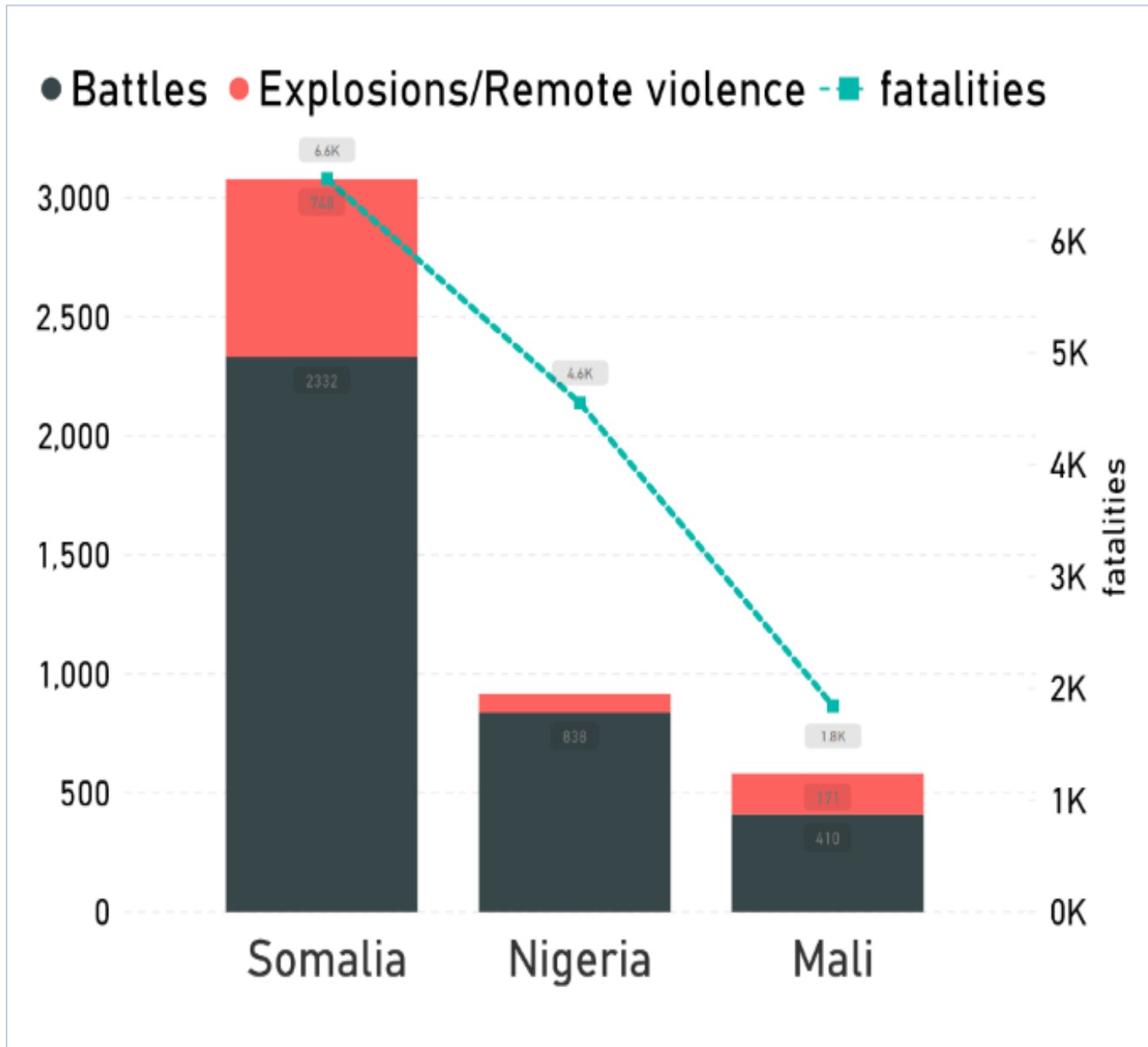



Mission Specific Threat Update

Should include

- Map of Region
- Map of IED Events
- Threat Actors
- Statistics e.g.
 - IED events
 - Difference in Sectors
 - Casualties
- IED users TTPs in Mission
- IED Event case study
- Common Components

- Examples included as
 - Somalia Slides 39 to 71
 - Mali Slides 71 to 87
 - **Both Examples need to be updated.**
 - **Instructor required to prepare similar updated information for the**



Somalia IED Threat Update





Conflict overview on Somalia

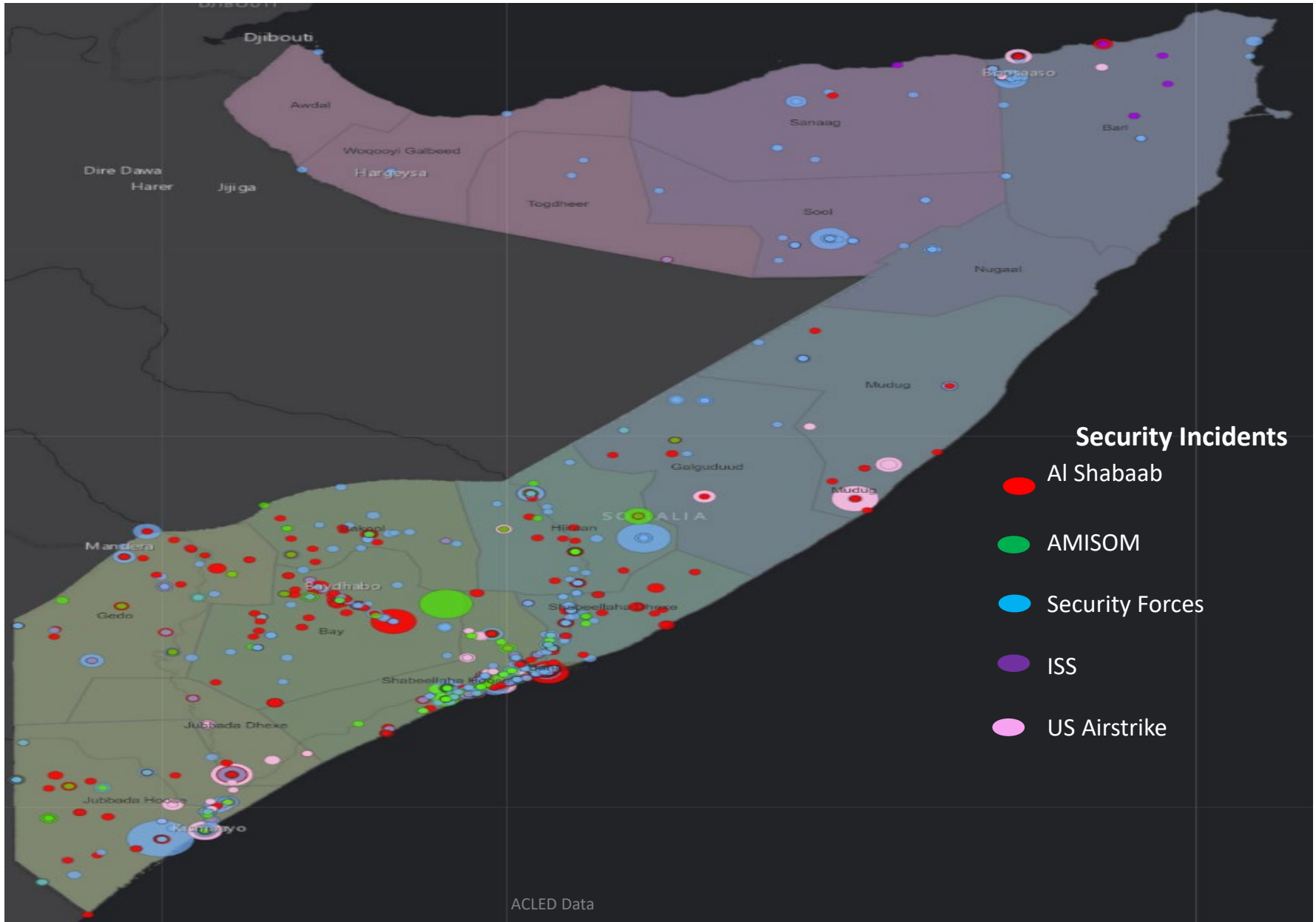



Casual factors to Al Shabaab endurance

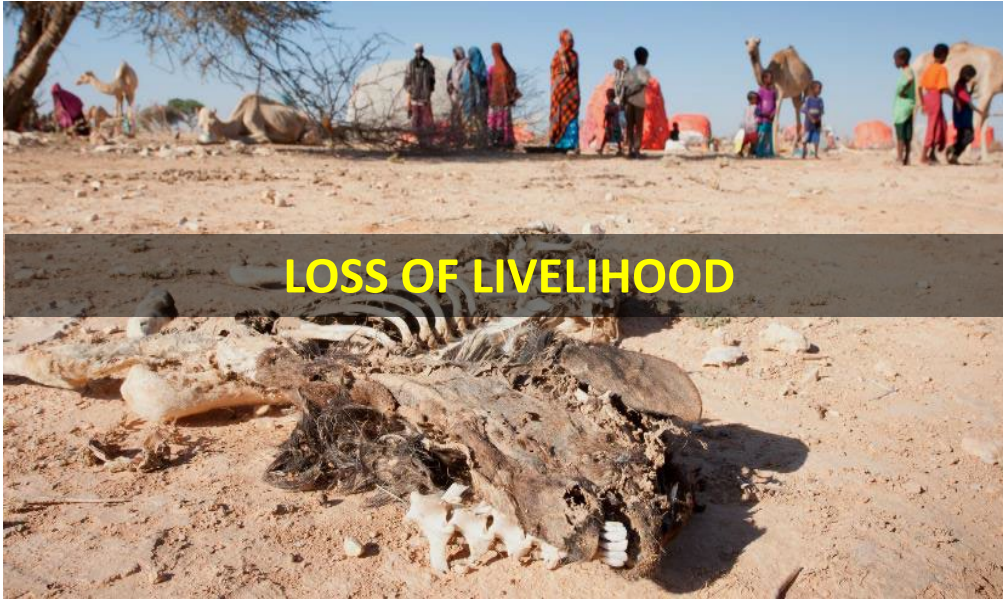

LOSS OF LIVELIHOOD



POVERTY & UNEMPLOYMENT



AGGRESSOR FREEDOM OF MOVEMENT



Somalia IED Threat Map

IED Incident Map AMISOM AOR

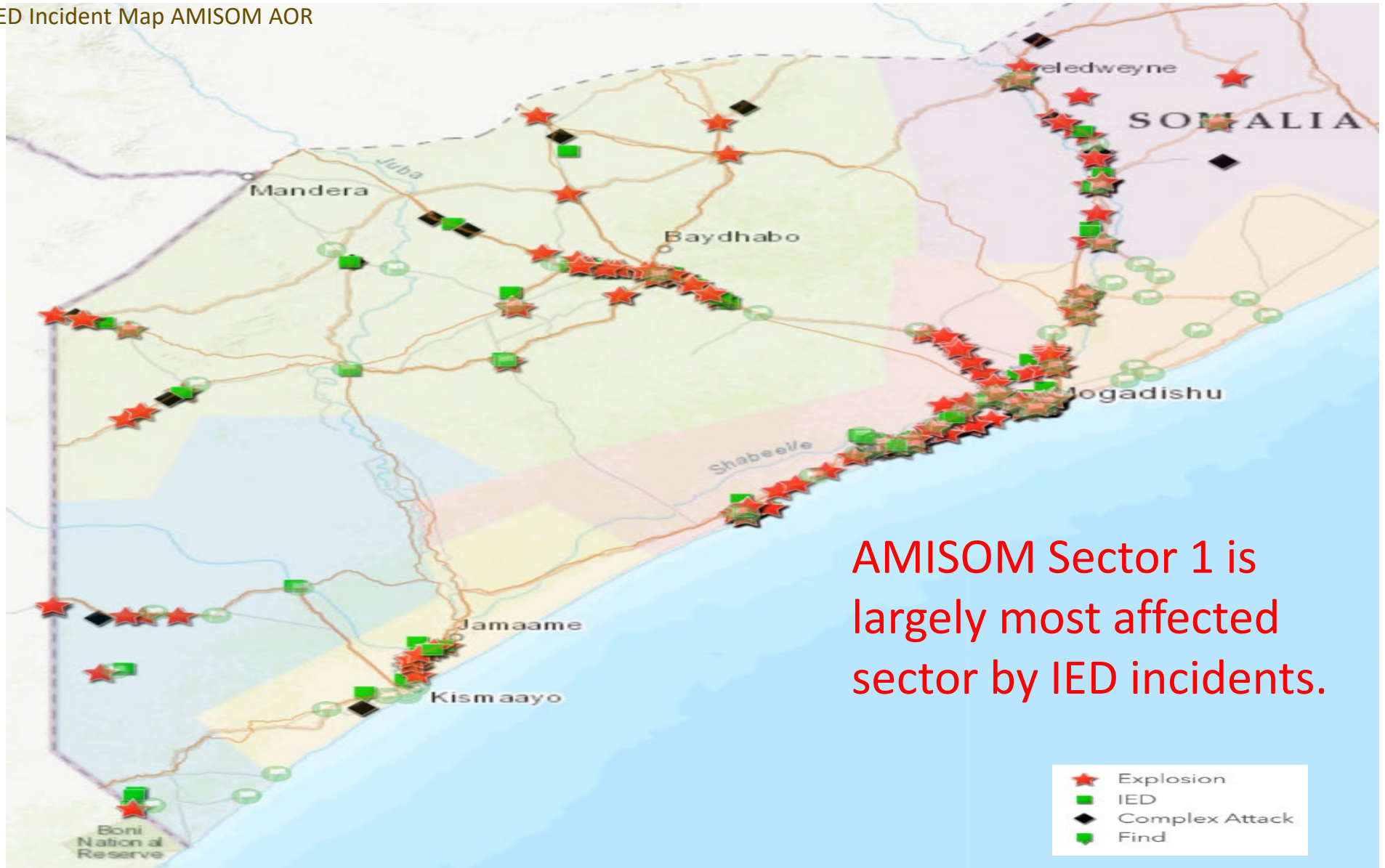

AMISOM Sector 1 is largely most affected sector by IED incidents.



Somalia IED Threat Heat Map

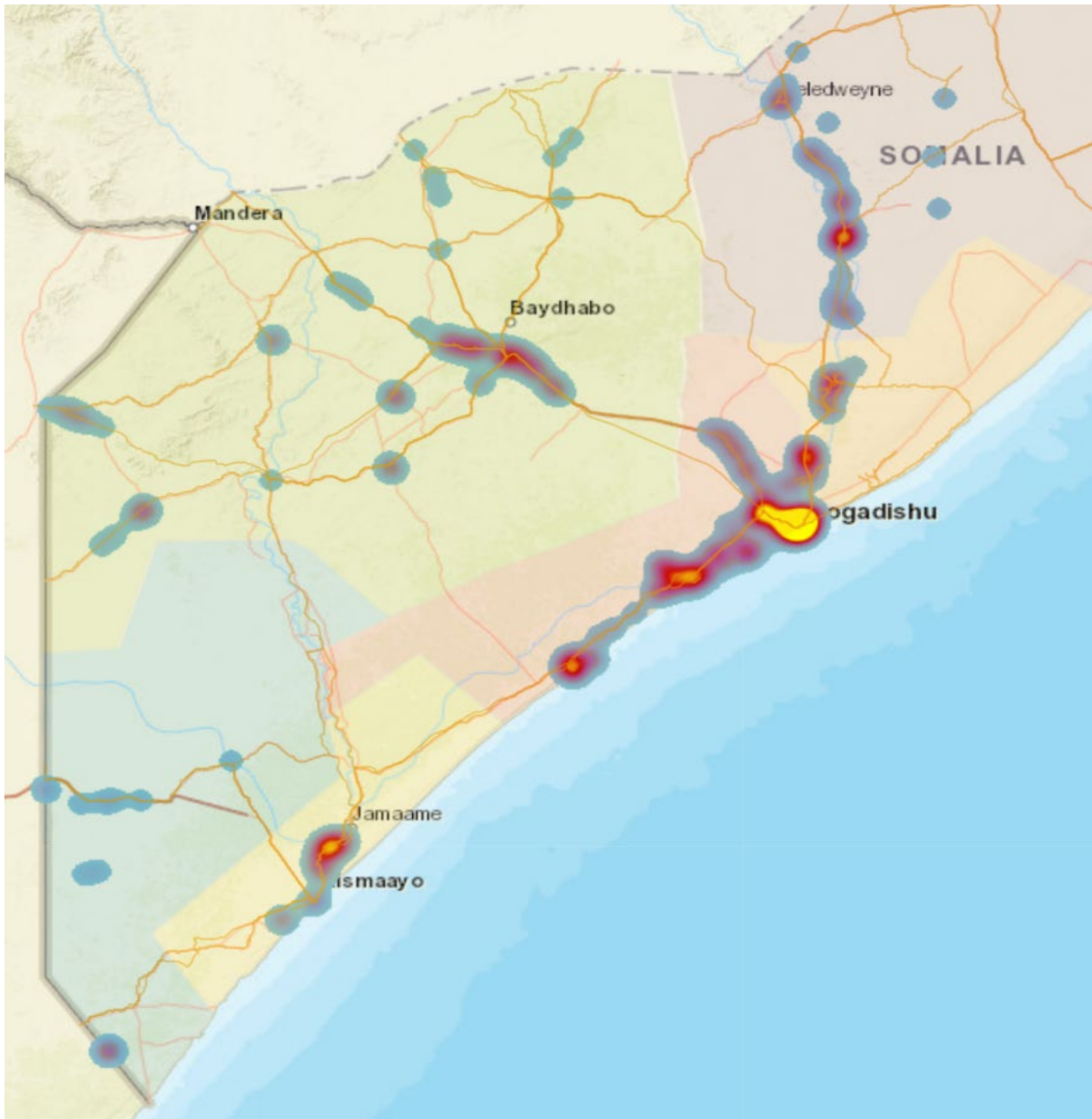

SOUTH CENTRAL SOMALIA

370+ IED Explosion incidents

85+ IED Find events

MOGADISHU

110+ Explosion incidents

5< IED Find events

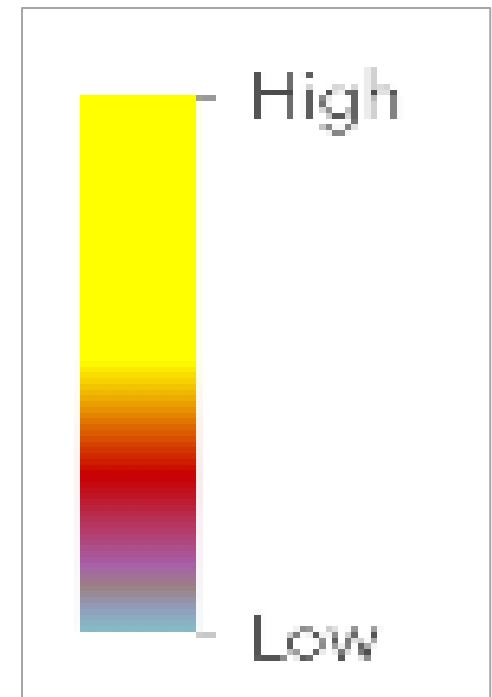



Somalia IED Threat Heat Map



IEDs emplaced on roads or roadside are the biggest threat to AMISOM and Somali Security Forces. Natural environment is conducive to burying or concealing IEDs along roads.



Somalia Assessed Target groups

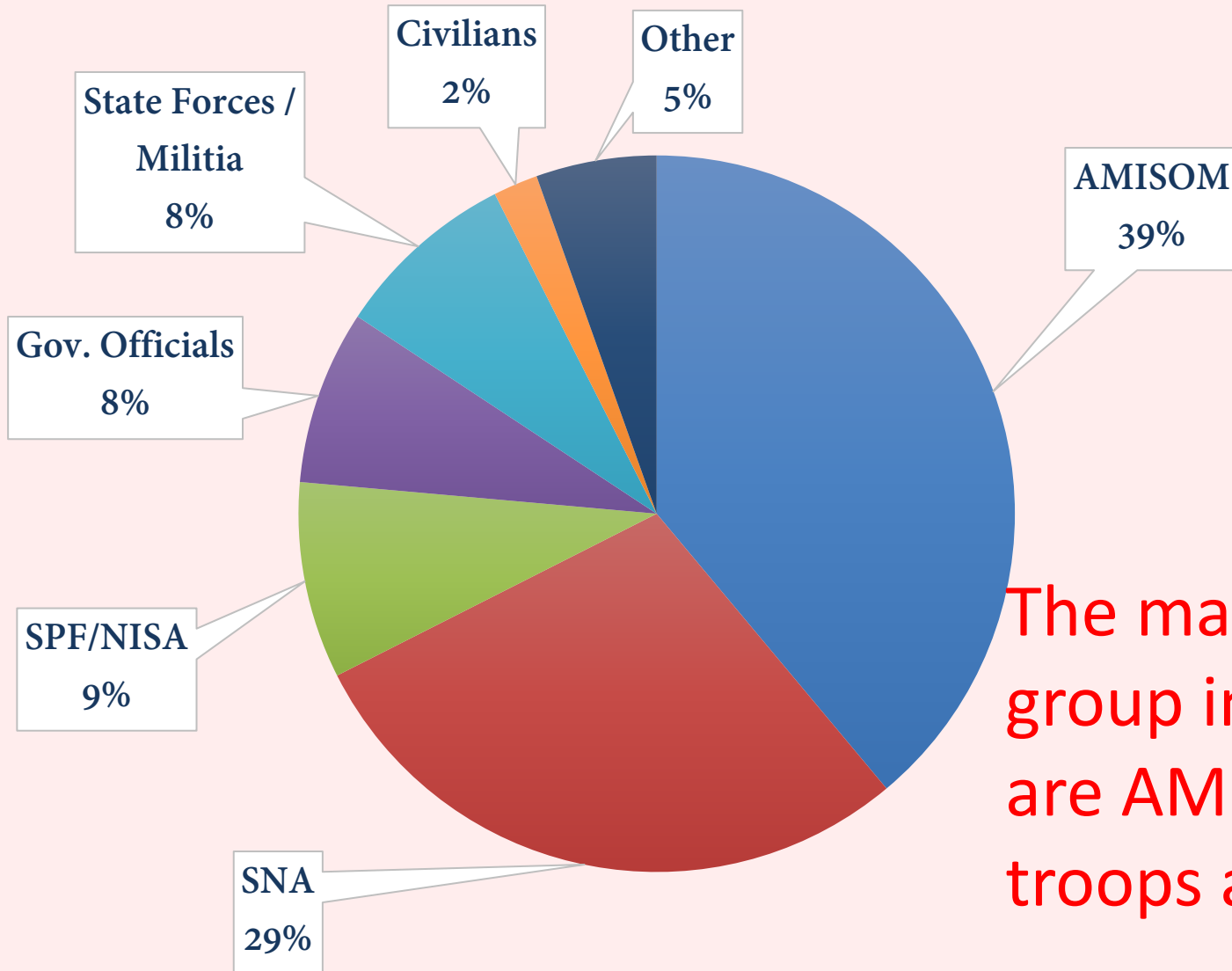

The main targeted group in Somalia are AMISOM troops at 39%.



Somalia Assessed Target Types

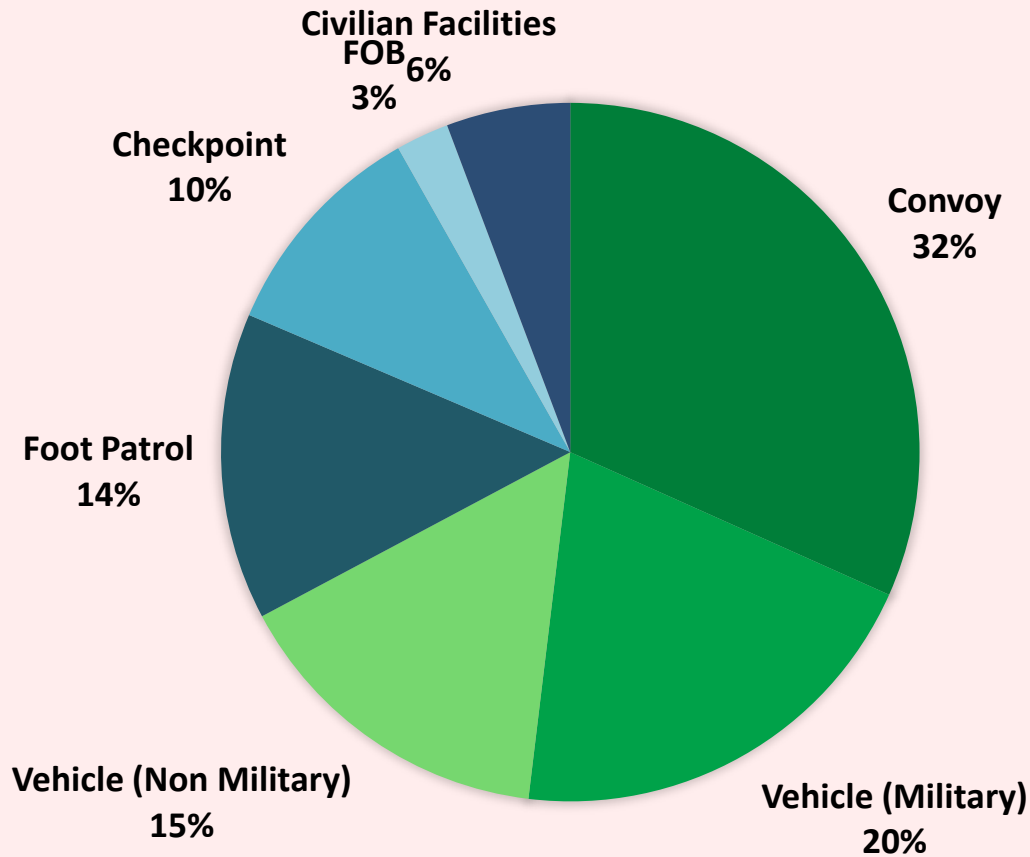

Main targets are AMISOM & SSF vehicle movements. AMISOM is most attacked security force, and due to training – equipment – mentoring - and lessons learned, AMISOM suffers less casualties than local security forces and civilians.



IED Casualty rates

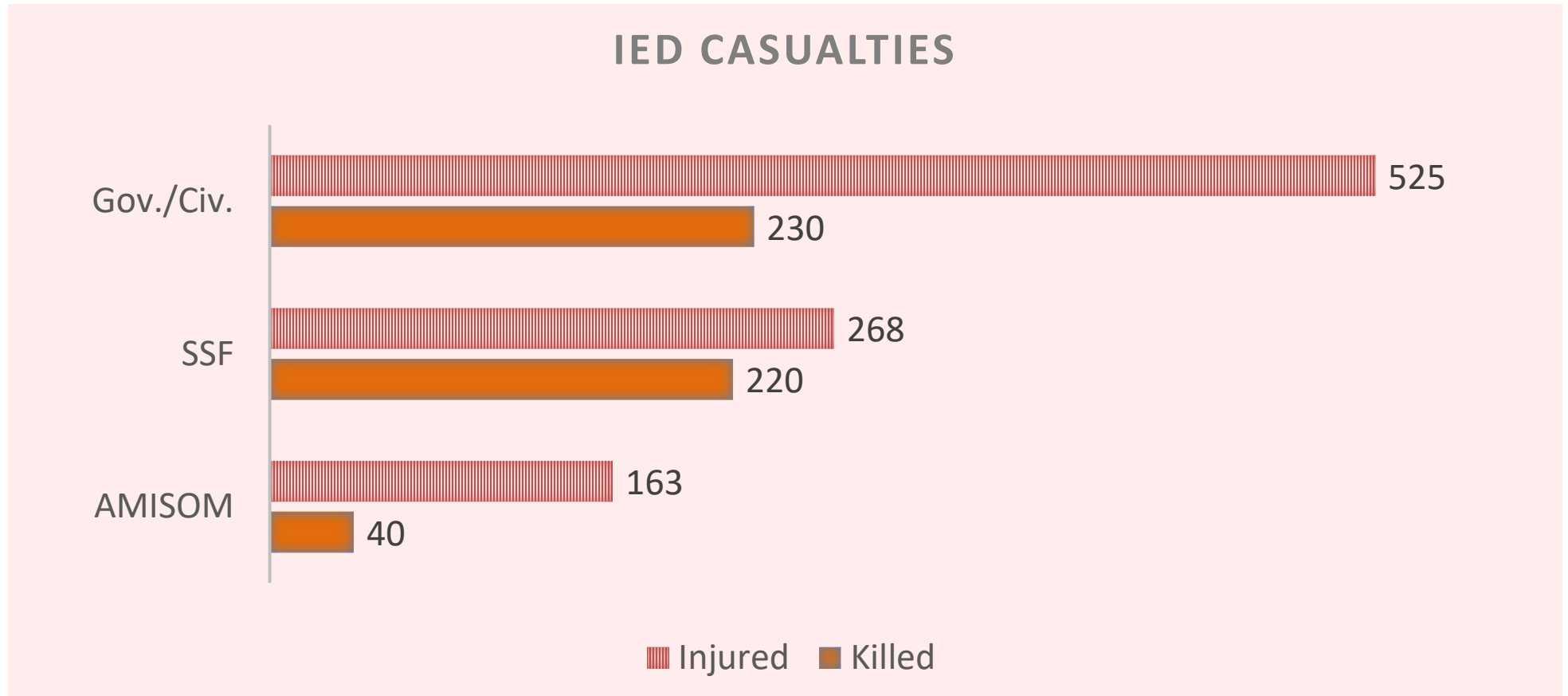

AMISOM is most attacked security force, and due to training – equipment – mentoring - and lessons learned, AMISOM suffers less casualties than local security forces and civilians.

IED Methods of Placement





IED Methods of Placement

SUBSURFACE



CONCEALED



IED Construction Methods





Commonly fabricated IED Containers

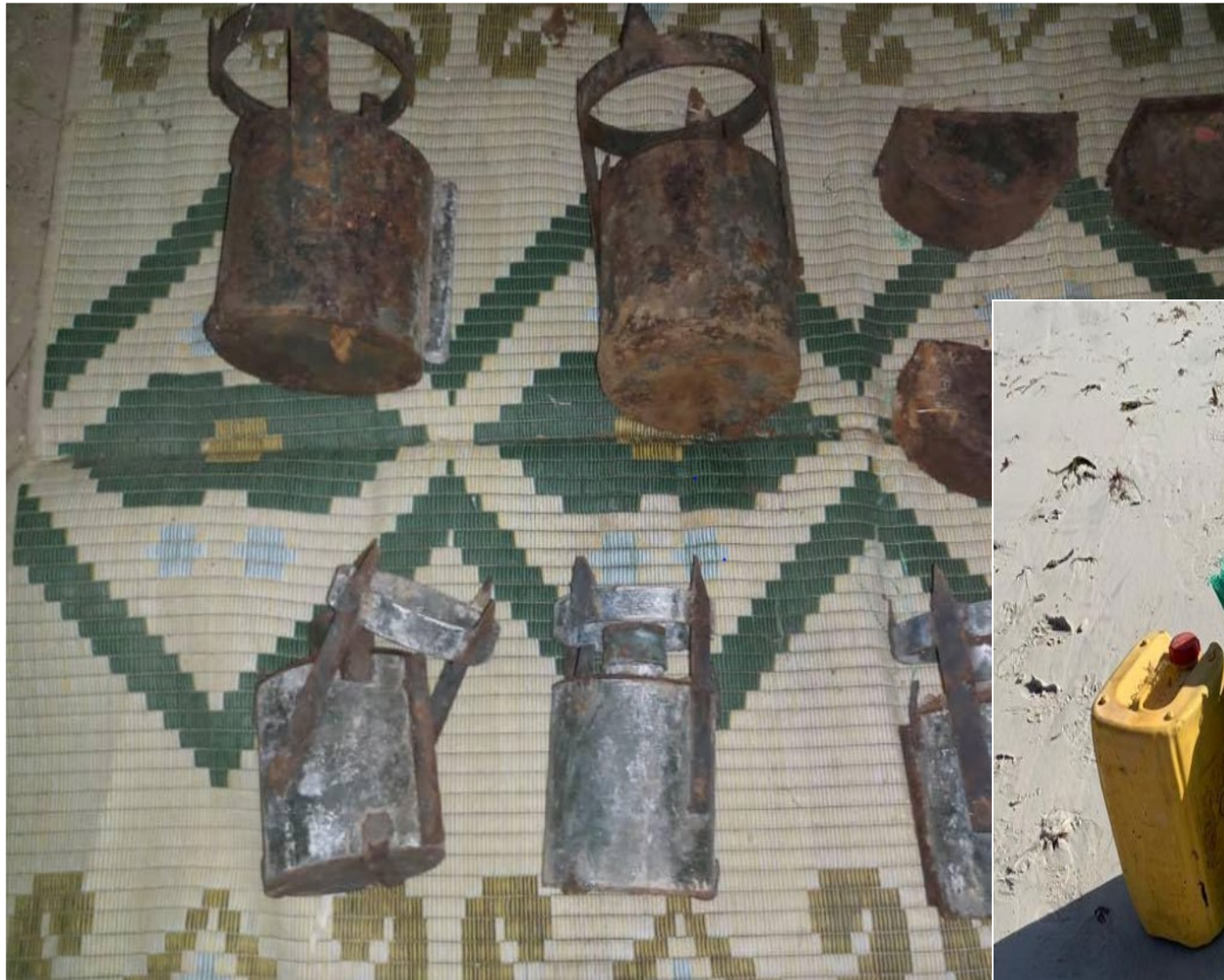



Common Power Sources IED Containers

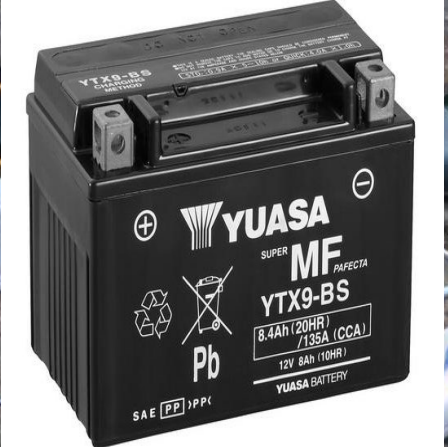

Motorcycle Battery



Sealed Lead Acid Battery



Common Wireless Receivers & Remotes



Receiver

Input Voltage: DC 12V

Channel: 1 Channel

Operating Frequency: 315MHz / 433MHz

Coding Way: Intelligent Learning

Output Type: Active Output

Maximum load: 10A

Ambient Temperature: -30 oC -70 oC, Humidity<95%

Board Dimension: 45x30.5x17mm

Case Dimension: 65x37x22mm



Report Date	Sector	Region	District	Location/village	Fertilizer comments
22/03/2017	1	L/Shabelle	Barawe	Eriile	This community use animal manure as fertilizers and sometimes chemical fertilizers from the market.
22/03/2017	4	Hiran	Beledweyne	Tuulo Hiiraan	Local farmers use traditional fertilizers like Bat manure, animal manure and some other chemicals that NGOs provided them like (Urea).
29/03/2017	4	Hiran	Beledweyne	Ilka Cado	Local farmers use traditional fertilizers like Bat manure, animal manure and some other chemicals that NGOs provided them like (Urea).
04/03/2017	5	M/Shabelle	Jowhar	Shamiindo	The community use mostly animal manure as fertilizer and sometimes synthetic chemicals from the market.
04/06/2017	3	Gedo	Luuq	Luuq	Farmers in Luuq mostly use animal waste as fertilizers and sometimes also use chemical fertilizers called Urea provided some time ago by FAO.
04/10/2017	5	M/Shabelle	Mahadaay	Maguurto	The community use Urea fertilizer.
23/5/2017	3	Gedo	Luuq	Buyle	The community uses animal manure and urea as fertilizers.
31/05/2017	3	Bay	Baidoa	Lafaale	The community uses animal manure and urea as fertilizers
29/05/2017	5	M/Shabelle	Jowhar	Gumbe	Villagers use animal faeces, urea and beans trees as fertilizers.
07/12/2017	4	Mudug	Galkayo	Harhaar	The community use Urea fertilizer.
24/7/2017	5	M/Shabelle	Balcad	Mareerey	The community use Urea fertilizer.
31/7/2017	5	M/Shabelle	Balcad	Muki Dheere	The community use Urea fertilizer.
14/8/2017	5	M/Shabelle	Balcad	Daniga	The community use Urea fertilizer.
21/8/2017	5	M/Shabelle	Balcad	Es'oy	The community use Urea fertilizer.
23/8/2017	1	L/Shabelle	Afgooye	Donweyne	The community use Urea fertilizer.
28/8/2017	1	M/Shabelle	Balcad	Walamooy	The community use Urea fertilizer.

Common Main





Common Electrical Initiators

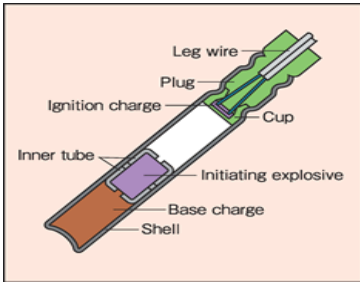

Features

- Firing current: 0.8 - 1.2 A
- Sealed / weatherproof construction

Report of the Monitoring Group on Somalia and Eritrea pursuant to Security Council resolution 2111 (2013):
Somalia

Smuggling of IED equipment and associated smuggling networks

7. The Monitoring Group previously documented (S/2013/413) a large shipment of weapons that had been supplied from Yemen to a location close to Qandala, in far northeastern Somalia, in October 2012. The arms cache included 220 RPG-7 boosters, 230 hand grenade detonators, a 73mm cannon, TNT, two bags of ammonium nitrate, five rolls of red detonating electric detonators (C-DET), making it one of the biggest seizures of weapons documented in Somalia in recent years.

The origins of these weapons were traced back to official stockpiles in Yemen, although it is unclear how these weapons were leaked from such stockpiles. This information was first reported by the Monitoring Group at the time suggested the entire cache had been smuggled into Somalia by an organized network of individuals.

The electric detonators were manufactured by C-DET Explosive Industries in Somalia. The Monitoring Group has since continued to document cases of C-DET detonators arriving in Qandala, and their use in IED attacks in various locations across southern Somalia. Indeed, on 9 December 2013, the Monitoring Group presented a new batch of 500 identical C-DET electric detonators that police had seized in Qandala.⁶⁷





Common Chemical Precursors

(U) Nitric acid is used in the production of the following HME*:

- Dinitrobenzene (DNB)
- Dinitrotoluene (DNT)
- Ethylene Glycol Dinitrate (EGDN)
- HMX
- Mercury Fulminate
- Nitrocellulose
- Nitroglycerine
- Nitrourea
- RDX
- Tetryl
- Trinitrotoluene (TNT)
- Urea Nitrate

* (U) Note: this list is not intended to be comprehensive.

(UNCLASSIFIED)

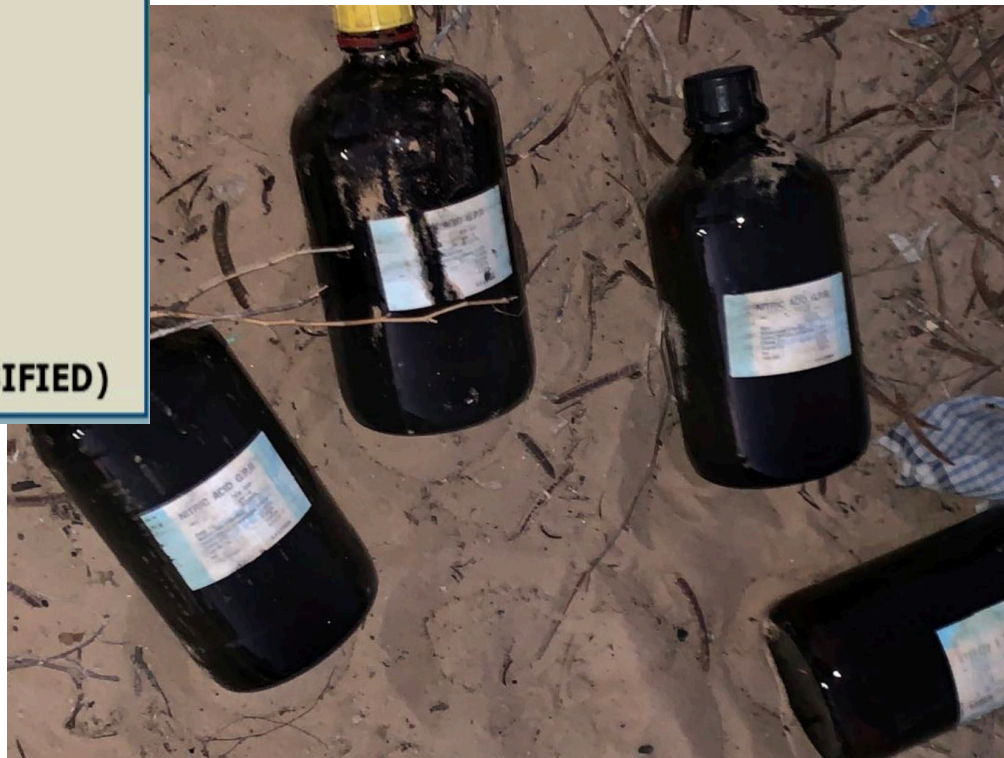



Under Vehicle IED (UVIED)

Detonator connections



Cell phone

Magnets



IED Incident



Charge
Location



IED Incident



Detonator and
shaped charge

Pressure plate



IED Incident



Ant hill used as the
Aiming marker



IED Location



IED Incident





IED Incident





IED Incident





IED Incident





IED Incident





IED Incident





IED Incident



IED Main charge



Pressure plate



IED Incident



Blast effects to SFs
Land cruiser



Common stages of an IED attack

Sunguuni – Marauding phase of the attack. A large number of AS fighters advance while suppressing defenders. AS propaganda

1. Initiation Stage
2. Marauding Stage
3. Security Forces Response
4. Second Attack
5. Conclusion/Aftermath



Key Messages to FOB Security

AMISOM re-occupation of Janale FOB

- Anti-SVBIED ditches
- Clear bushes
- Reinforced
- Relationship
- Multiple Security barriers



IED Enablers / Networks

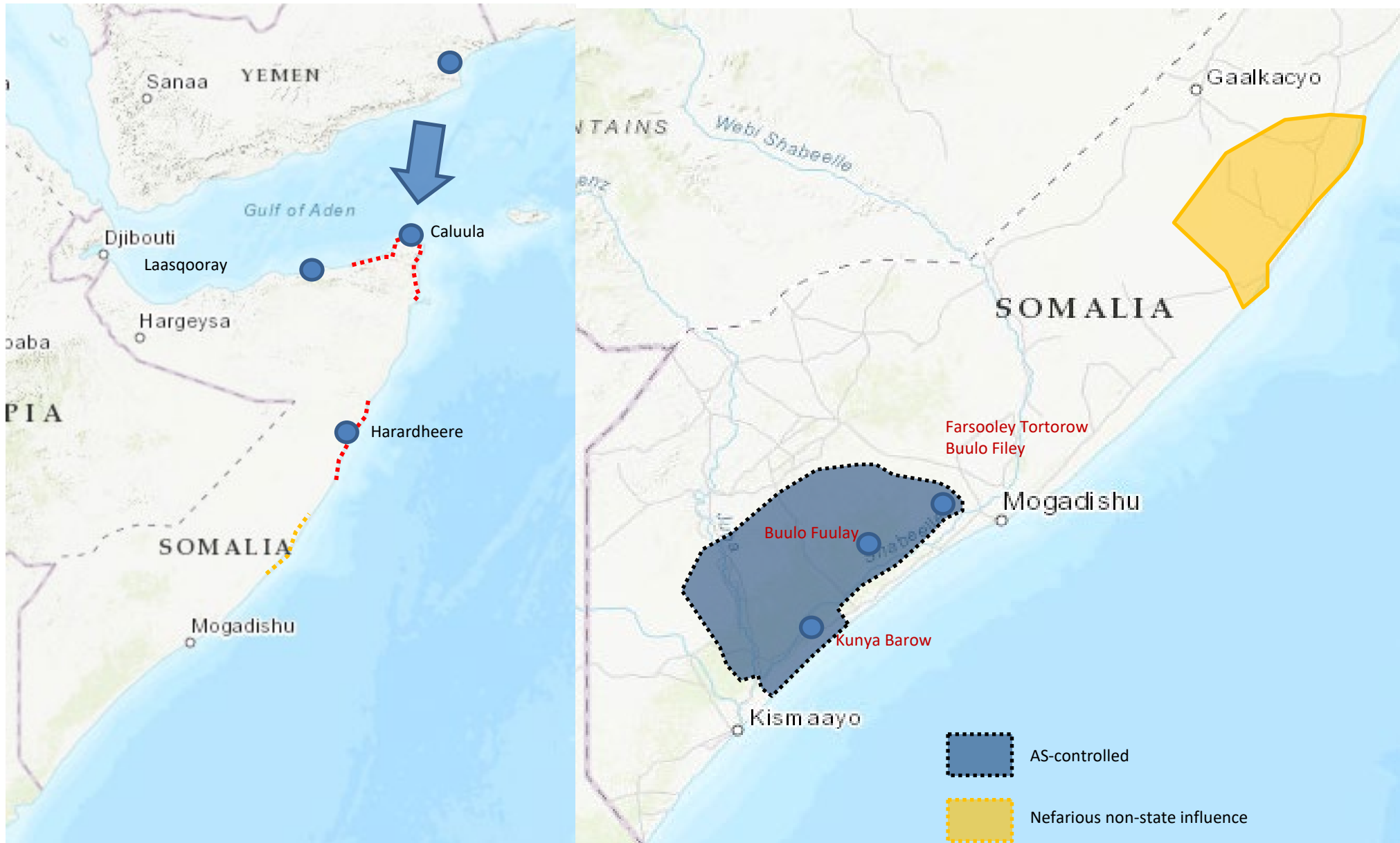



The Threat in Mali – Asymmetric Warfare

- Security Forces Vs Opposing Groups:
 - Security forces numbers
 - Technology
- Opposing Groups Tactics:
 - Small groupings
 - Freedom of movement
 - Blend in
 - Insurgency tactics - exploit weak points
 - Aim - to project power and disrupt security operations





The Threat in Mali – Asymmetric Warfare

Convoy operations

- Essential to supply the mission
- Essential to the continuing peacekeeping effort
- Vulnerable to attack:
 - SAF
 - IED/mine
 - Complex attacks
- High value targets
- Easy to attack – Terrorist POV





The Threat in Mali – TAG

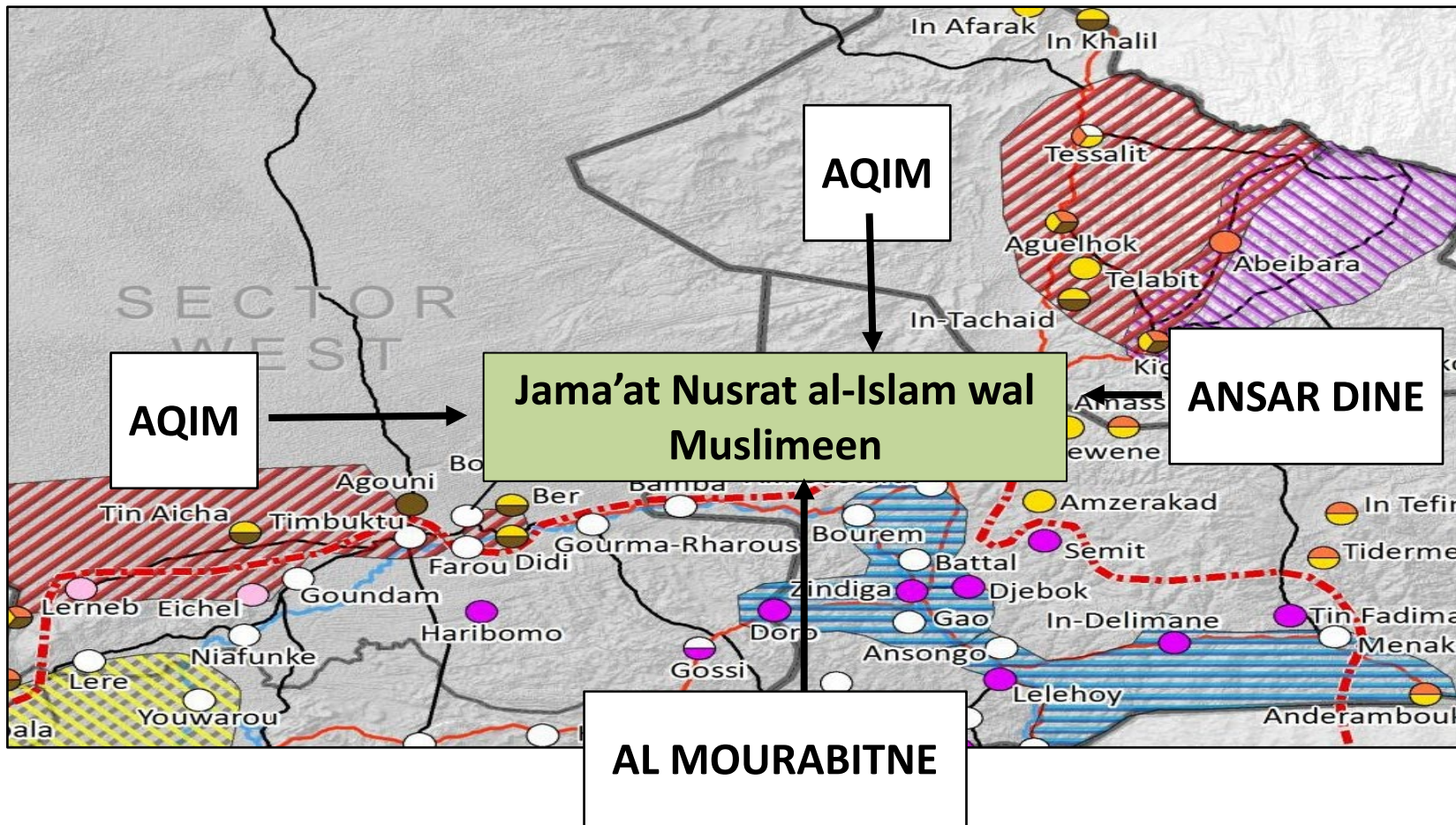



The Threat in Mali – IED Threat

Preferred weapon of choice for insurgents

- Cheap
- Easy to make
- Specific to the attack
- Easy to hide

Complex attack

- IED used as a precursor





The Threat in Mali – IED Threat

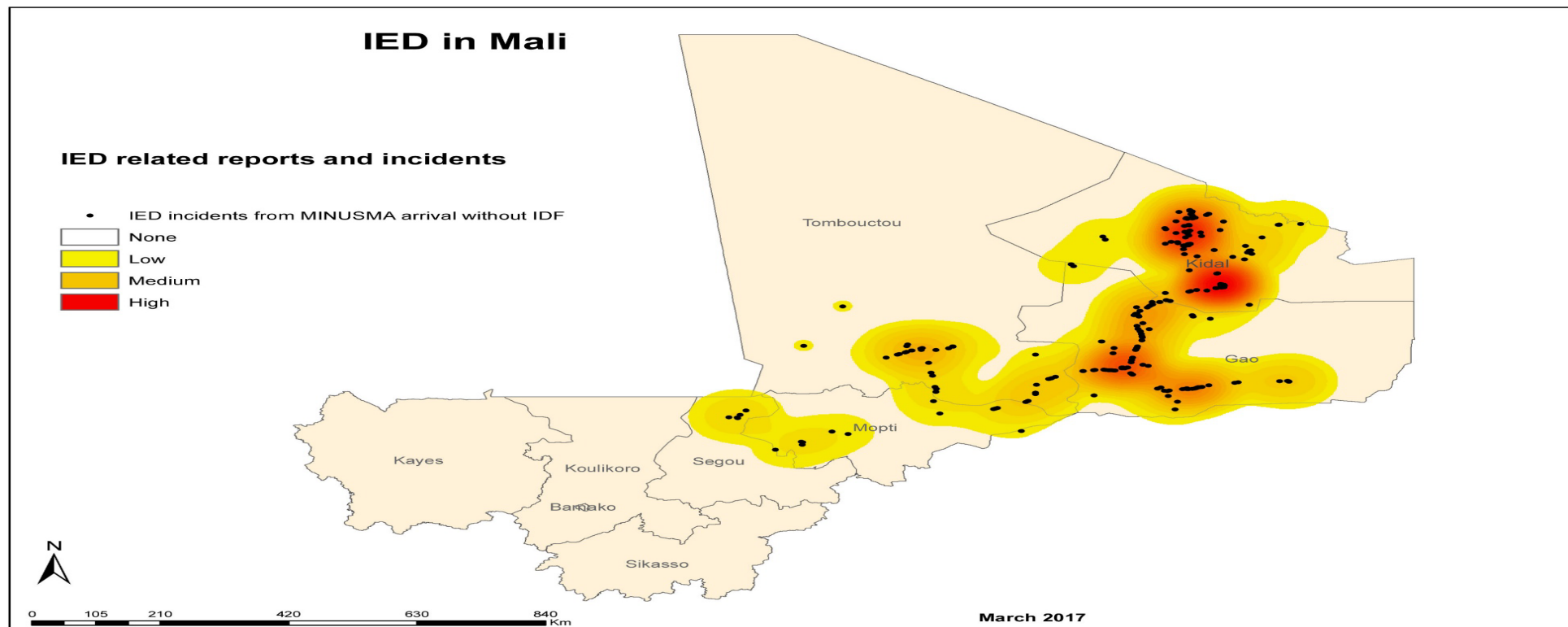

Sector North (Kidal & Tessalit) and Sector East (Gao) remain the focal points for TAG



The Threat in Mali – IED Threat

- Incidents by region

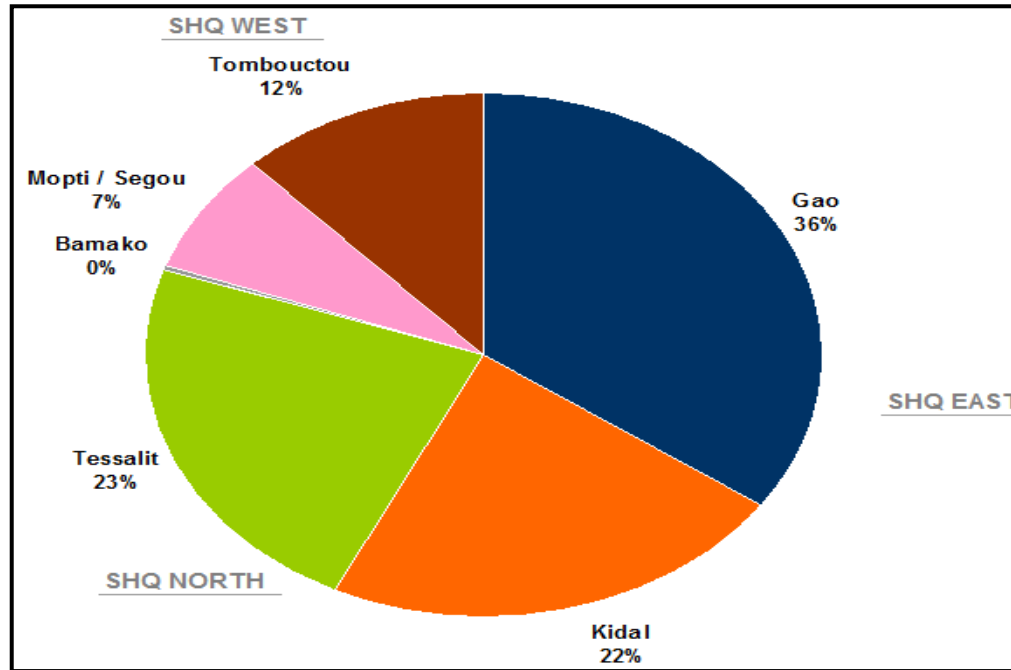



The Threat in Mali – IED Threat

- Incidents by month

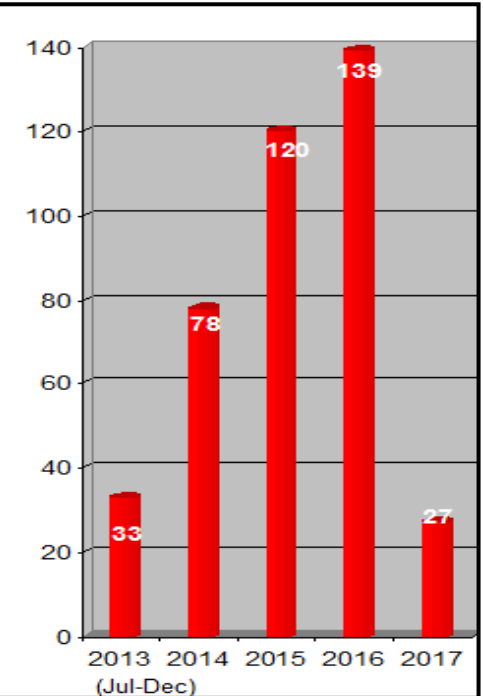
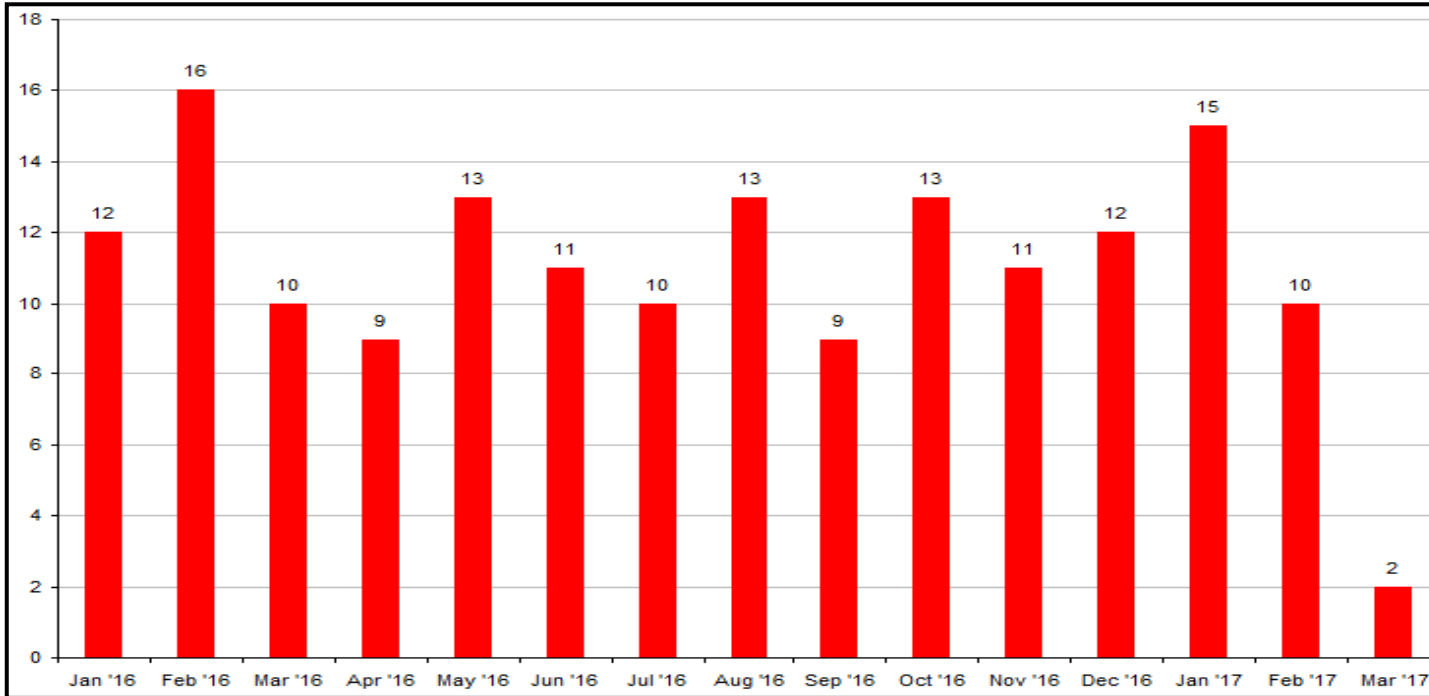



The Threat in Mali – IED Threat

- IED - Detonated, collected and neutralised

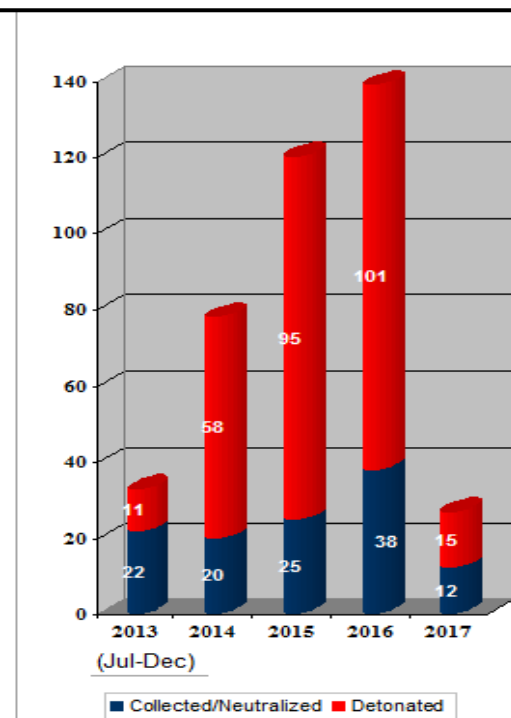
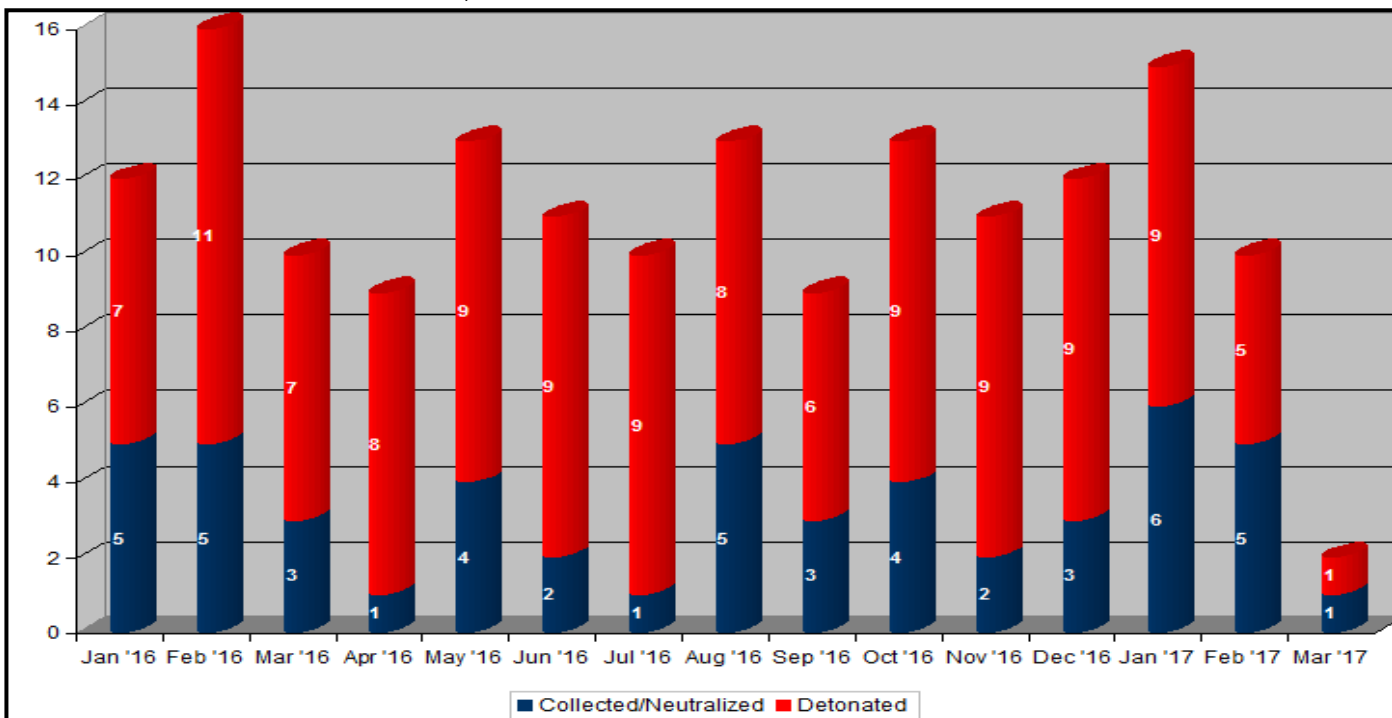



The Threat in Mali – Methods of Attack

- Annual comparison

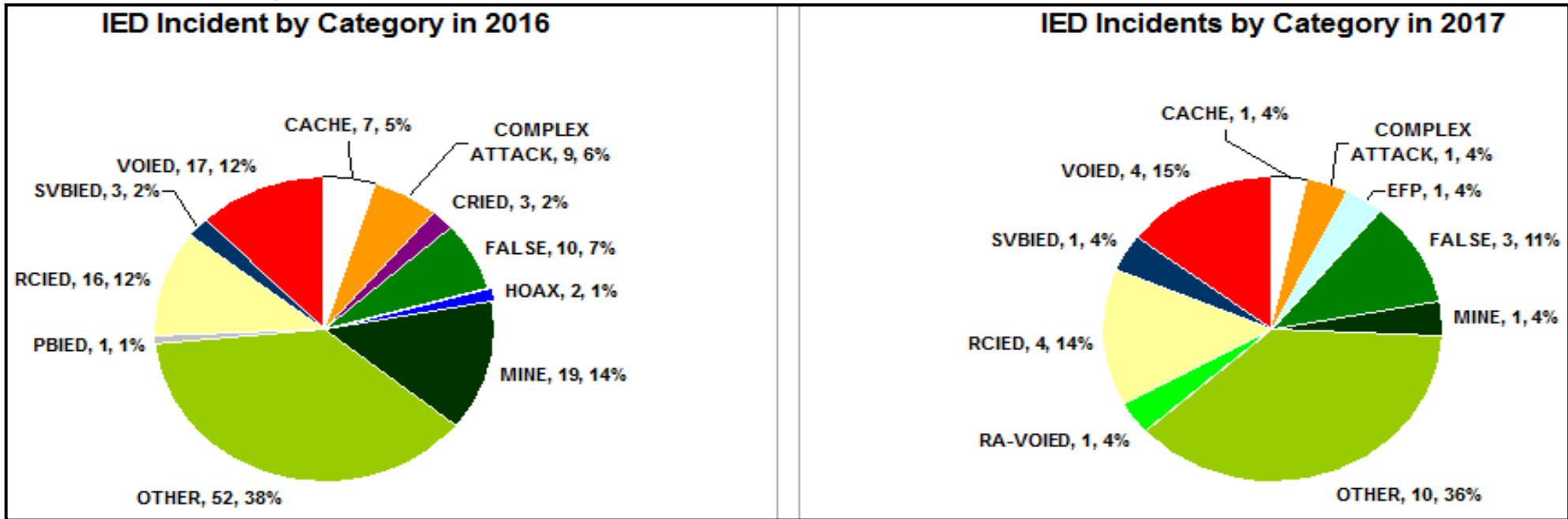



The Threat in Mali – Methods of Attack

- Incidents by category

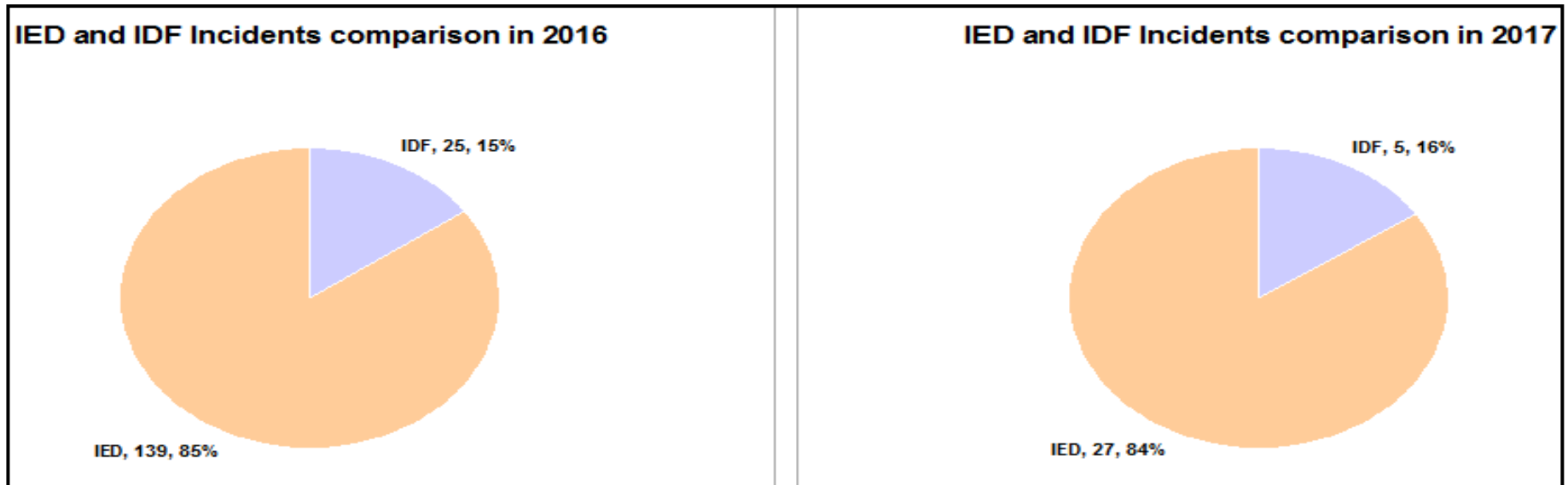

IEDs and Mines are the greatest threat to MINUSMA.



The Threat in Mali – Methods of Attack

Small Arms Fire (SAF)

- Force protection
- Unarmed civilian logistical vehicles
- All round defence
- Likely firing positions
- Mobile attacks





The Threat in Mali – Methods of Attack

Complex Attack

- Becoming more common
- IED used as a pre-cursor
- Follow up attack could include:
 - Heavy weapons
 - Mortars
 - Rockets





The TAG Attack Cycle

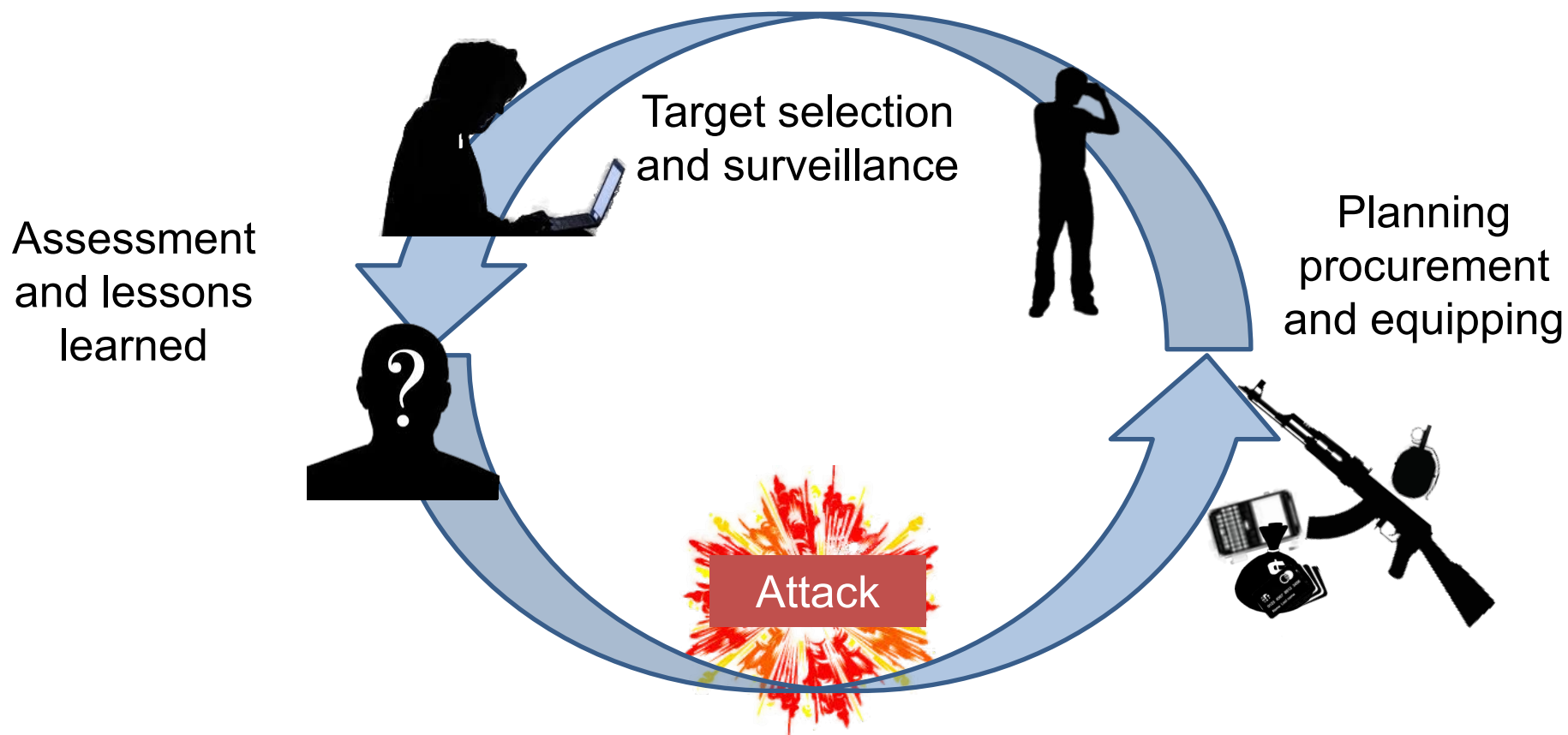



The TAG Attack Cycle

TAG watch results, assess effectiveness, adjust future attacks to be more effective

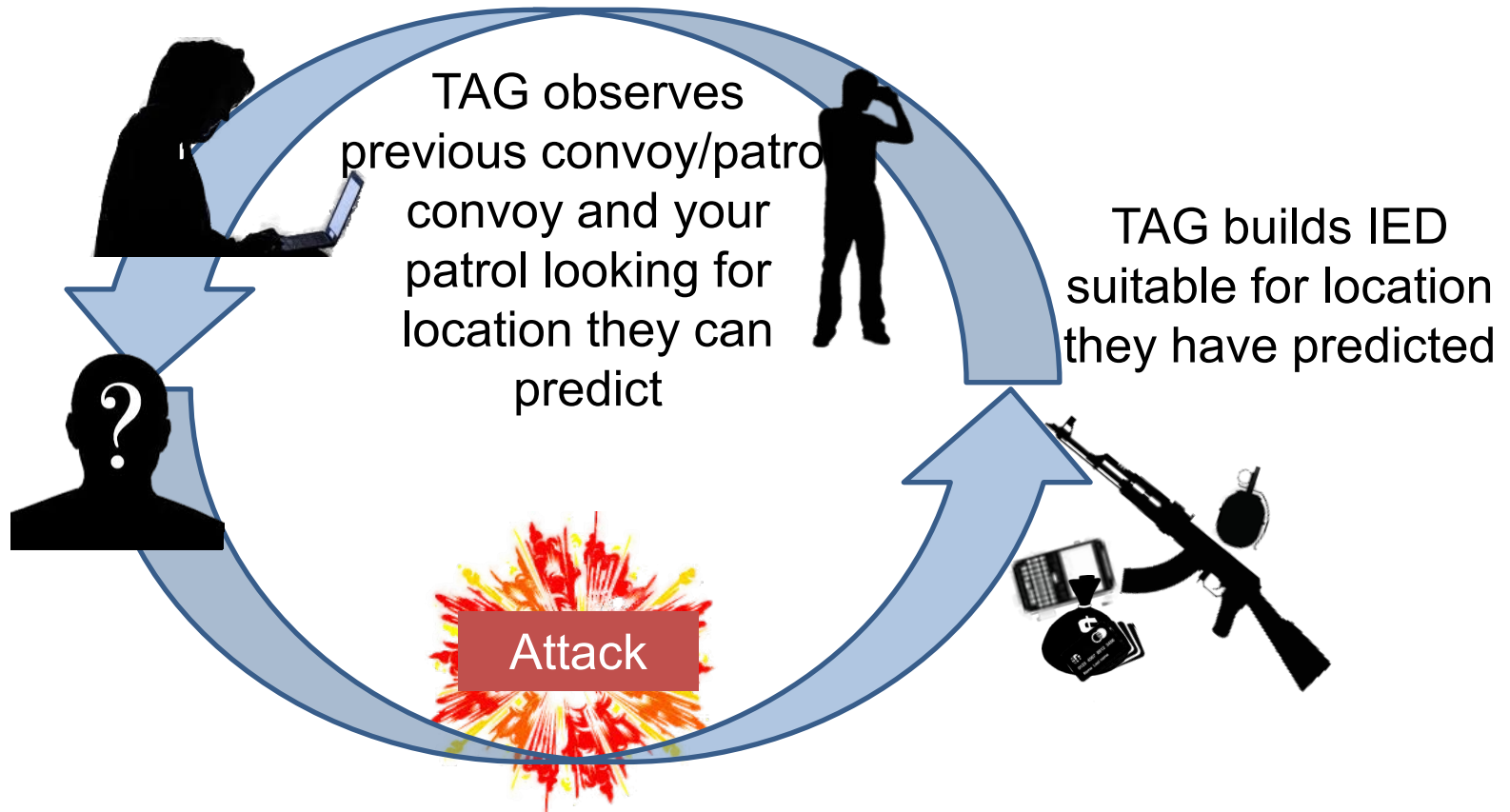



Lessons Learned

CORRECT APPROACH TO IED DEFEAT

- Pre-Deploy / Continuous Training
- IED Brief before any Operation
- Mobility Planning with IED Update
- EOD guidance in Operations
- Ground Domination is key
- Hold Areas Liberated

Enemy TTPs

- Increase use of RCIED
- Possible “Lures” to attract EOD
- Good Ground Intelligence
- Deploy IEDs fast and in large quant.
- Adaptation Capacity to new TTPs
- Remains Successful in IED Tactics



Summary

Throughout history, and with varying effectiveness, groups have resorted to the use of IEDs to advance a particular cause or wear down an adversary. IEDs are used by terrorists to strike soft targets and by insurgents as weapons against a stronger enemy. They can be made at relatively low cost, are relatively easy to construct and emplace, and can achieve both strategic and tactical results.



Look forward to...

Module 1.2
Explosive Hazard Awareness,
Threats and Explosive
Remnants of War



All Arms Search Course (AASC)

Module 1.2 Explosive Hazard Awareness, Threats and Explosive Remnants of War



Ground Rules

- Time
- Safety
- Questions
- Notes
- Phones/Devices
- Food/Drink
- Previous knowledge
- Assessment



Scope of Lesson

1. Definitions
2. Classification
3. The Threat





Module Objective

- At the end of this module, the participants will be able to recognize areas that may contain Explosive Remnants of War (ERW).



Definitions

- Explosive Ordnance (EO)
- Ammunition / Munition
- Unexploded Ordnance (UXO)
- Explosive Remnants of War (ERW)
- Abandoned Explosive Ordnance (AXO)



Definitions

- Explosive Ordnance (EO)

All munitions containing explosives, nuclear fission or fissionable materials and/or biological/chemical agents.



Definitions

- Ammunition / Munition
 - Complete device charged with explosives, propellants, pyrotechnics, initiating composition, or nuclear, biological or chemical material for use in military operations, including demolitions.



Definitions

- Unexploded Ordnance (UXO)
 - Explosive ordnance which has been primed, fused, armed or otherwise prepared for action, and which has been fired, dropped, launched, projected or placed in such a manner as to constitute a hazard to operations, installations, personnel or material and remains unexploded either by malfunction or design or for any other cause.



Definitions

- Explosive Remnants of War (ERW)
 - Unexploded Ordnance (UXO) and Abandoned Explosive Ordnance (AXO).
- Abandoned Explosive Ordnance (AXO)
 - Explosive ordnance that has not been "fired" or used as designed, that has been left behind or dumped. AXO may or may not have been primed, fused, armed or otherwise prepared for use.



ANY QUESTIONS?



Quiz

1. What does the following definition refer to:

explosive ordnance which has been primed, fused, armed or otherwise prepared for action, and which has been fired, dropped, launched, projected or placed in such a manner as to constitute a hazard to operations, installations, personnel or material and remains unexploded either by malfunction or design or for any other cause...’?

– *Unexploded Ordnance (UXO)*



Definitions

2. What is the definition of 'explosive remnants of war (ERW)?

- *Unexploded ordnance and abandoned explosive ordnance.*

3. What is the acronym Abandoned Explosive Ordnance?

- *AXO*



Quiz

4. What is considered a complete device charged with explosives, propellants, pyrotechnics, initiating composition, used in military operations, including demolitions?
 - *Ammunition/ Munitio*n

5. What do you call munitions containing explosives, and / or biological / chemical agents.
 - *Explosive Ordnance (EO)*



Classification

- Placed
 - purposely positioned by hand either on the surface or sub-surface in a specific location.
- Thrown
 - physically thrown by a person.



Classification

- Projected
 - ordnance that is ejected or propelled from a weapon or weapon system.
- Dropped
 - dispensed or dropped from an aircraft or ship.



Examples of Placed

PLACED MINES





Examples of Thrown





Examples of Projected

- Rifle Grenades
- Mortars
- Rockets
- Projectiles
- Missiles
- Small Arms Ammunition (SAA)



Examples of Projected





Examples of Dropped

- Sub-Munitions
- Dispensers
- Bombs



Examples of Dropped

DISPENSER

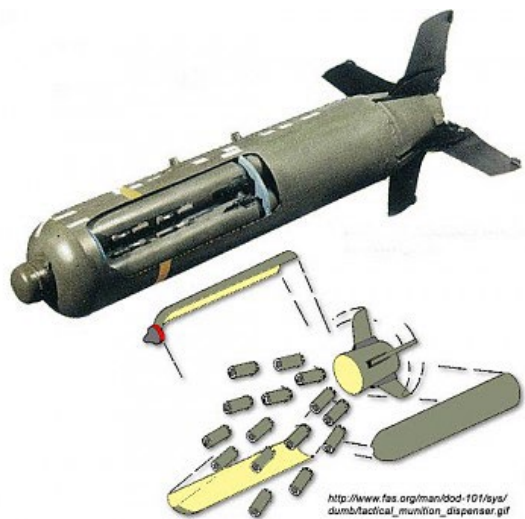

SUB-MUNITIONS



General Purpose Bomb



Classification

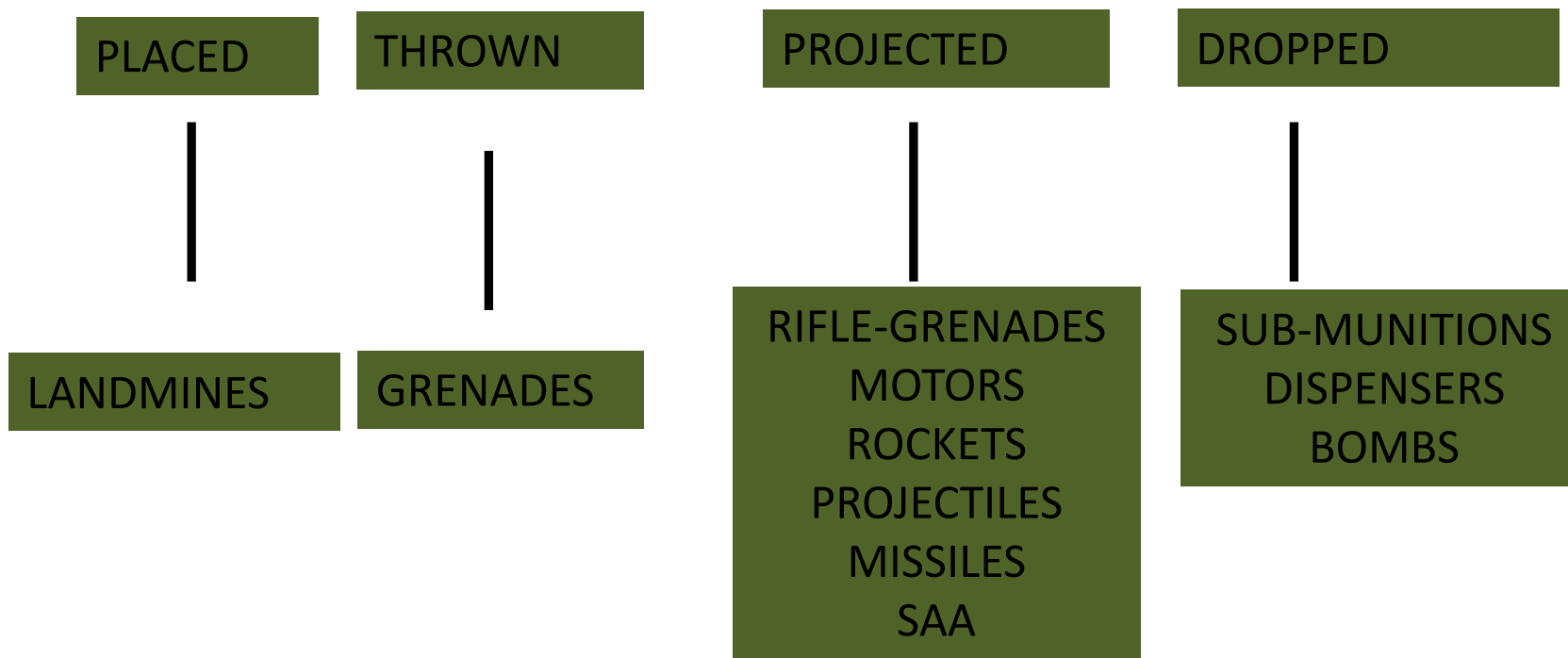



Types of Ordnance

It is determined by type of effect:

- Projectile
 - HE (High Explosive)
 - HEAP (High Explosive Armor Piercing)
 - IL (Illumination)
 - WP (Smoke)
 - HEAT (High Explosive Anti-Tank)
 - HEP (High Explosive Plastic)
 - RAP (Rocket Assisted Projectile)



ANY QUESTIONS?



Quiz

1. How is Ordnance classified?

–The method of delivery

2. What are the different classifications of UXO?

–Placed, Thrown, Projected, Dropped



Quiz

3. What are the types of ordnance that are classified under DROPPED ?

–Sub-munitions, Dispensers, Bombs

4. What are the types of ordnance are classified under PROJECTED ?

–Rifle grenades, Mortars, Rockets, Projectiles, Missiles



Explosive Remnants of War

Strike indicators

- Skins. The skins will normally be at the start of the strike area.
- Wpn Components. Next to the skins will be the associated container furniture.
- Impact area. The impact area will be found next.
- Container/ Tail. The carcass of the container will be found at the furthest point



Explosive Remnants of War





Explosive Remnants of War





UXO

- Explosive ordnance which has been primed, fused, armed or otherwise prepared for use or used. It could have been fired, dropped, launched or projected yet remains unexploded either through malfunction or design or for any other cause.



UXO





UXO





UXO





ANY QUESTIONS?



EXPLOSIONS OVER A PERIOD OF TIME WITH NO SIGN OF DELIVERY





ERW

ENTRY HOLES





ERW

Damage caused by delivery, no sign of explosion





Presence of UXO indicated by:

- The UXO, or part of it, being visible
- Explosions over a period with no sign of delivery
- Entry holes
- Damage caused by delivery, no sign of explosion
- Packaging and remains of delivery system



ANY QUESTIONS?



Questions

- What is UXO?
- What Categories of LSA are there?
- What are the combat indicators of UXO?



Summary

- Identification of LSA, UXO and Explosive Remnants of War is a component of the C-IED Threat Assessment. Understanding what you have seen and being able to describe that to the EOD operator is vital in ensuring the safety of yourself and your comrades.



Look forward to...

Module 1.3 –
5/25s
Vulnerable Points
And Vulnerable Areas
CAGE & CMSA



All Arms Search Course (AASC)

Module 1.3 –
5/25s

Vulnerable Points
And Vulnerable Areas
CAGE & CMSA



Range

- Time
- Safety
- Questions
- Notes
- Phones/Devices
- Food/Drink
- Previous knowledge
- Assessment



Module Objective

At the end of this module, the participants will be able to recognize Vulnerable Points (VPs) and Vulnerable Areas (VAs) concerning explosive hazards along with how these areas and points factor into their personal threat assessment and to conduct the 5/25s drill.



Teaching Points Covered

- 5/25s
- Definitions
 - Vulnerable Points
 - Vulnerable Areas
- Discussion of common VPs and VAs
- Google Street View / Map Exercise of VP/VA Identification
- Introduction of CAGE
 - Channeling
 - Aiming Markers
 - Ground
 - Environment / Atmospherics
- Demonstration of 5/25s



Conduct C-IED Checks

- Conduct 5/25m checks
- Conduct additional security checks
- Actions on IED Find/Suspected



5 & 25m Checks

Explosive effect (full PPE)

- Greatly reduced at 5m
- Further reduced at 25m

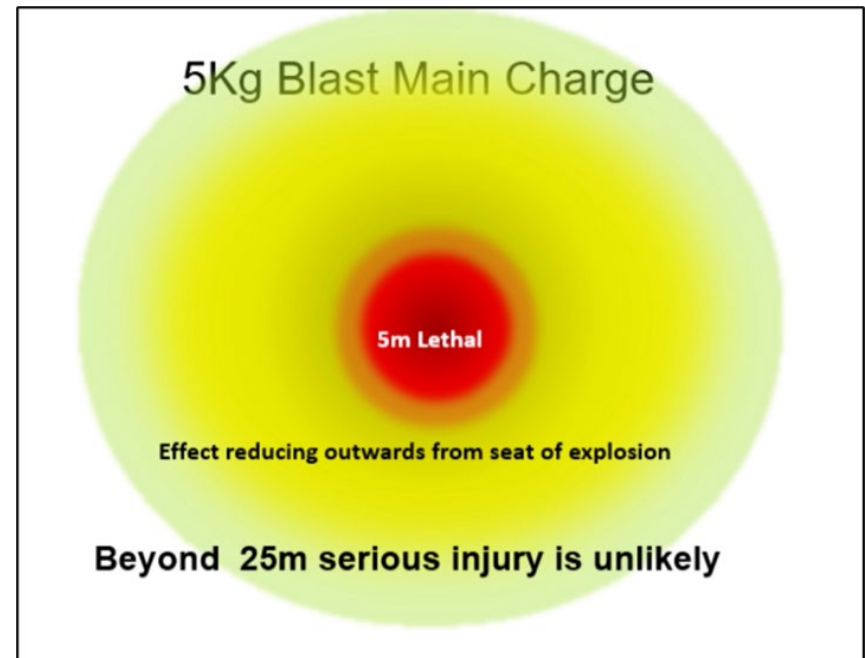



5 & 25m Checks





5 & 25m Checks

- Considerations:
 - Number and type of vehicles
 - Number of troops available
 - The ground
 - The threat
- The basic principles remain the same



5 & 25m Checks

Procedure:

- A single vehicle
 - Driver
 - Commander
 - Gunner
 - 4 personnel
- Can be adapted





5 & 25m Checks

Procedure

- Observe the route
- Select a stop point
- Observation





5 & 25m Checks

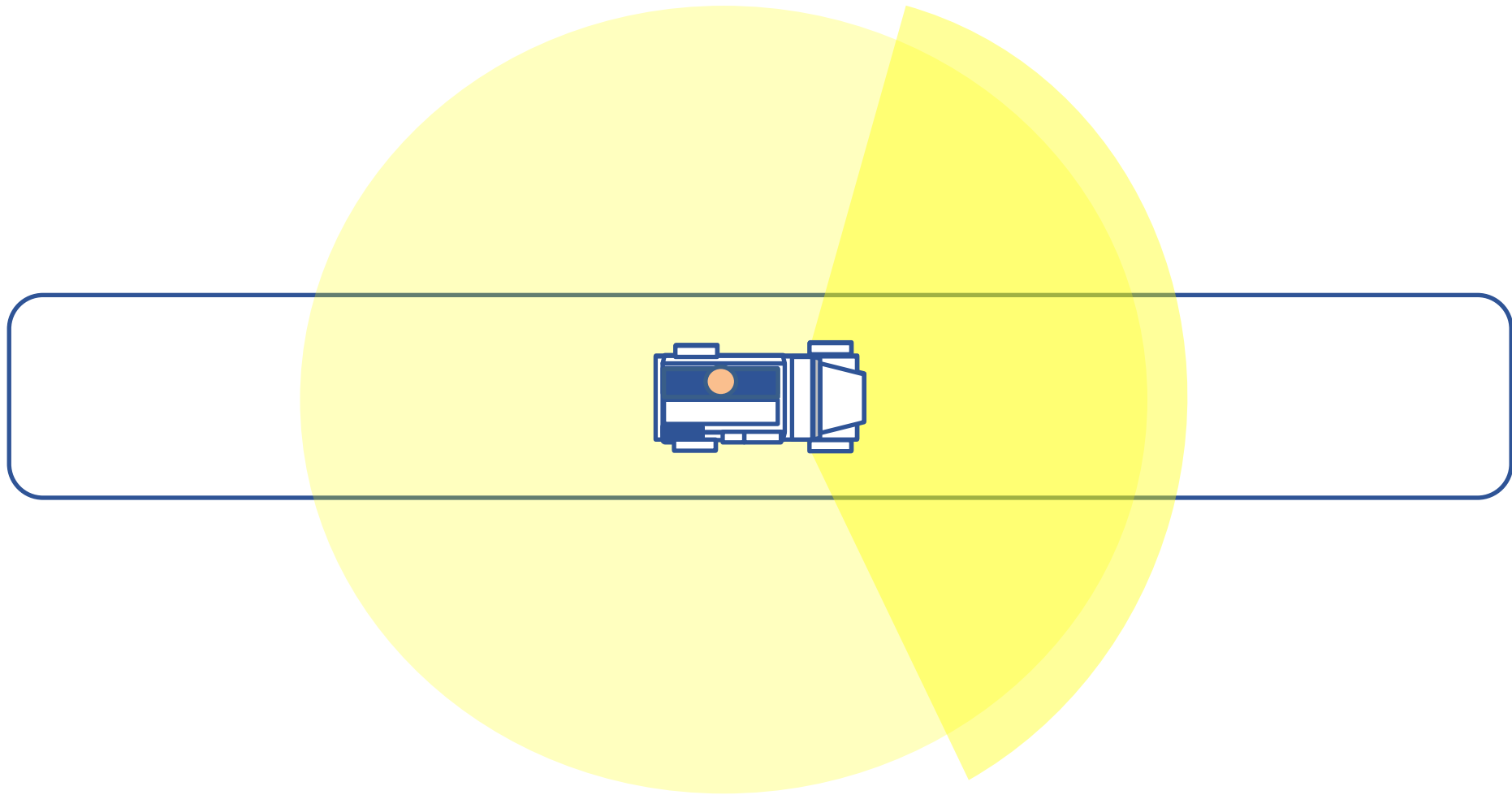



5 & 25m Checks

Procedure

- Observe the route
- Selects a stop point
- Observation
- 5m check



5 & 25m Checks

5m Check

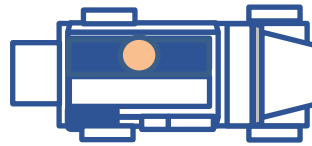



5 & 25m Checks

5m Check

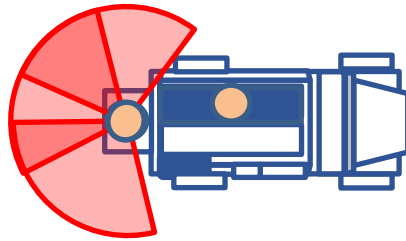



5 & 25m Checks

5m Check

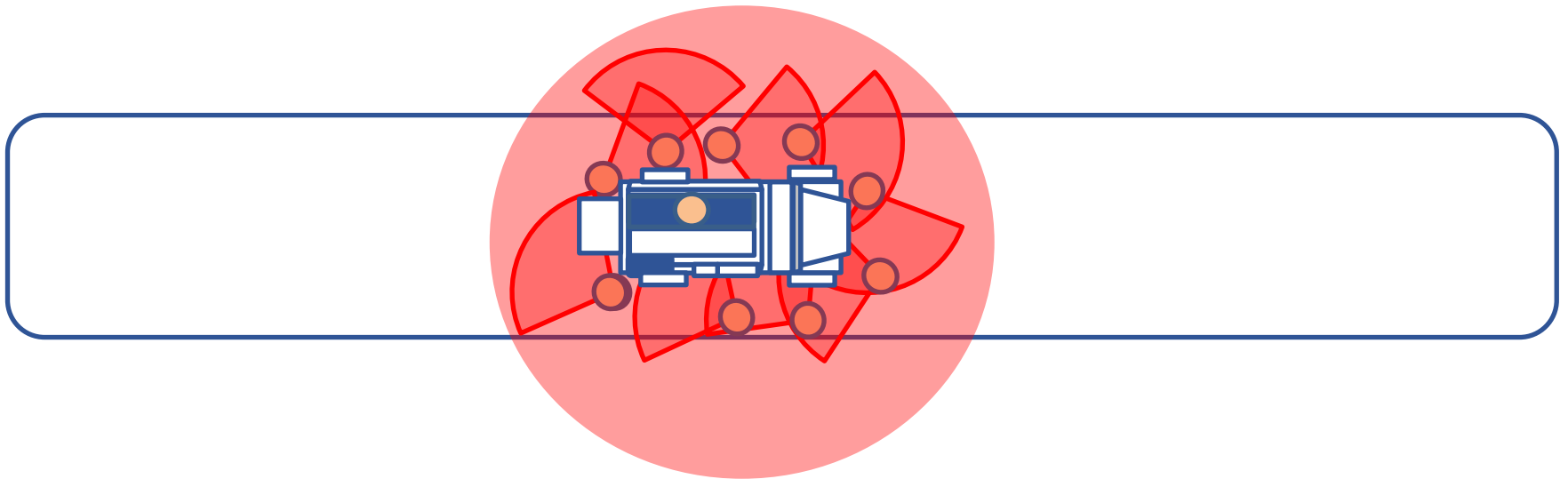



5 & 25m Checks





5 & 25m Checks

Procedure

- Commander observe the route
- Commander selects a stop point
- Gunner completes a 360 observation
- 5m check
- 25m check



Stage Three – 25 Check

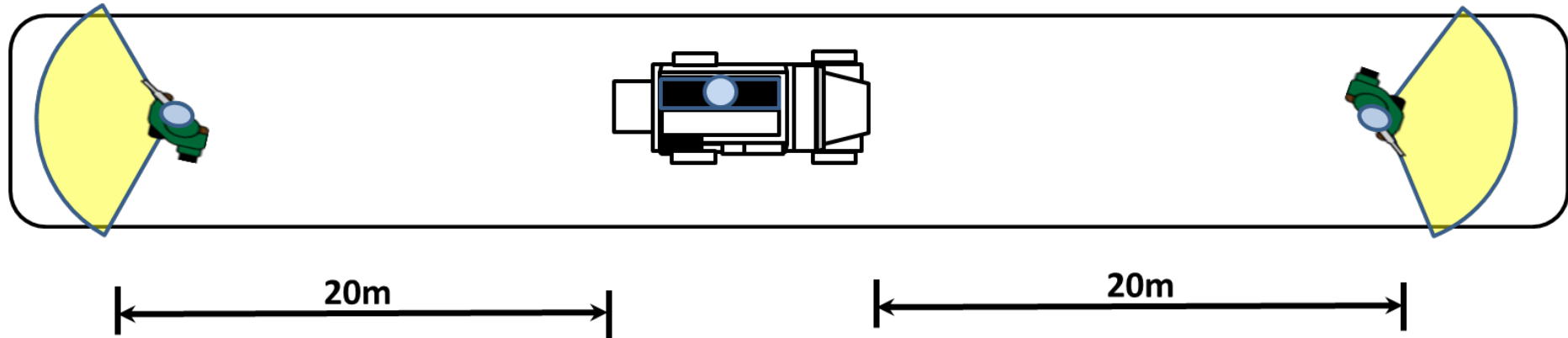



Stage Three – 25 Check

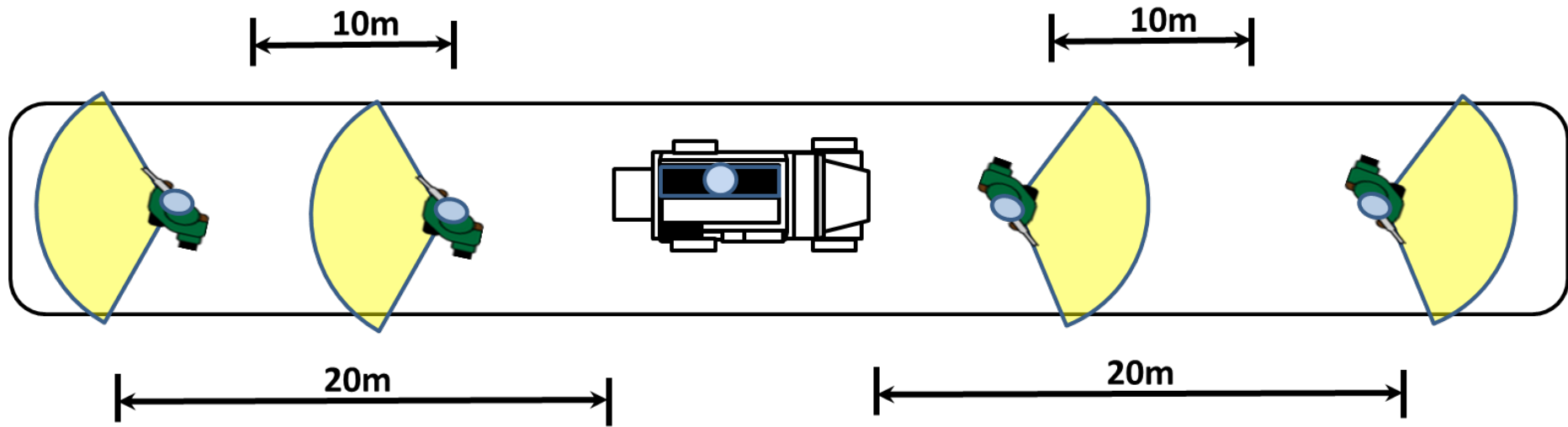

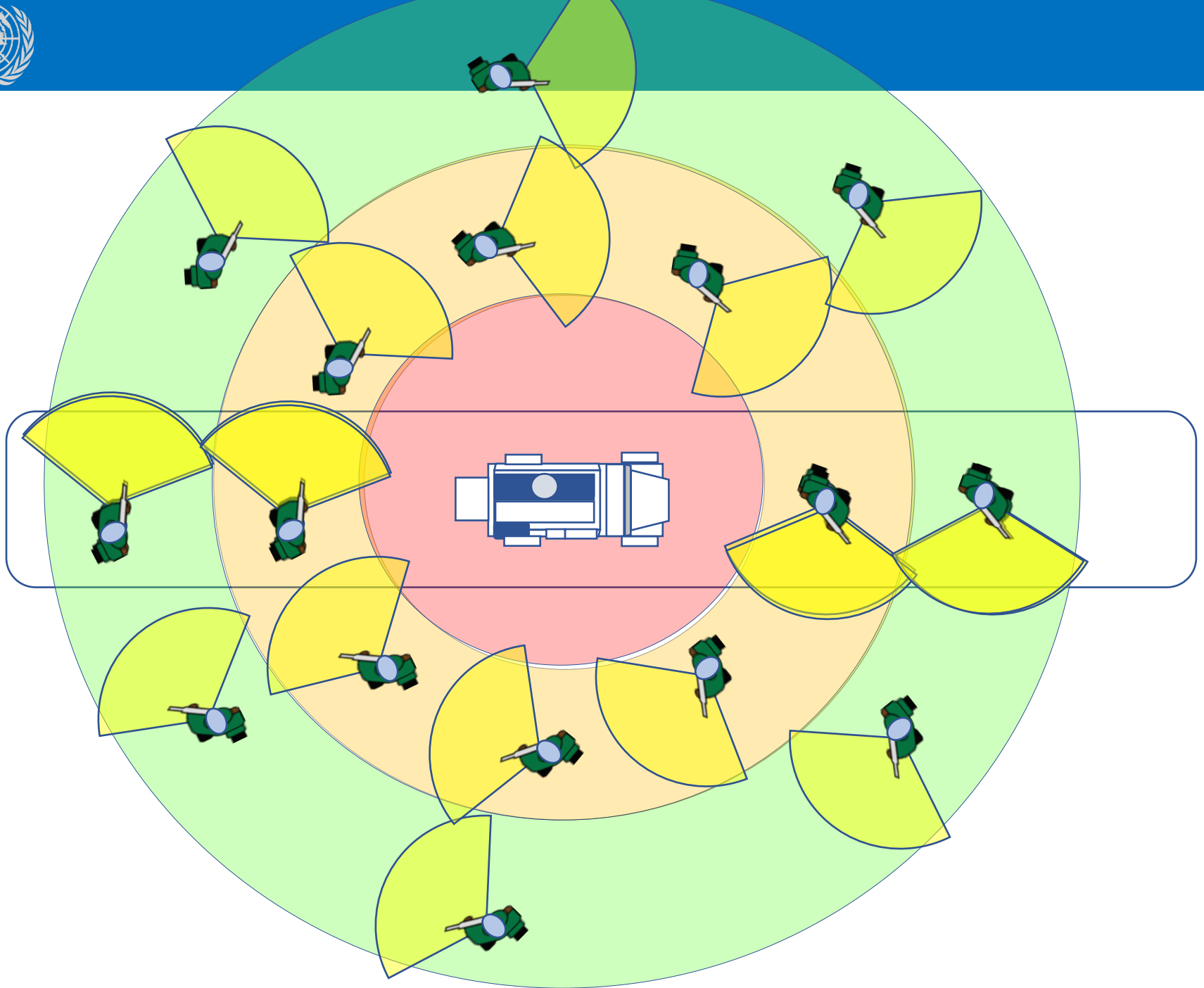



Stage Three – 25m Check





5 & 25m Checks

Procedure - revision

- Commander observe the route
- Commander selects a stop point
- Gunner completes a 360 observation
- 5m check
- 25m visual check



5 & 25m Checks

General points

- Look for ground sign
- Look up as well as down
- Overlap areas
- Communication
- Spacing
- Overwatch
- Actions on a find





5-25 m check



Approved for Public Release



ANY QUESTIONS?



Understanding VAs and VPs

- **Vulnerable Points**

‘VPS are points along a route where it is advantageous for the Enemy to initiate an attack using IEDs, Small Arms Fire (SAF) or both.’

- **Vulnerable Areas**

‘VAs are those areas where a target (you) can be predicted to be, but where no specific point offers obvious advantage’



Understanding VAs and VPs





Understanding VAs and VPs

Route Analysis

Allows us to focus our attention on specific points or areas on a route.

Patterns of roadside attacks:

- Regular patterns set by military and police forces during the move
- Channeled areas
- Slow go terrain/checkpoints
- Site where IED can be easily placed and hidden
- Aiming marker / clear line of sight
- Key terrain that supports follow-on ambush



Understanding VAs and VPs

What are VAs and VPs?

Vulnerable Points

VPS are points along a route where it is advantageous for the Enemy to initiate an attack using IEDs, Small Arms Fire (SAF) or both.

Vulnerable Areas

VAs are stretches of route or areas that present significant advantages to an adversary wishing to mount an attack. The location will directly depend on the adversary's Freedom of Movement, capability and any limitations either self-imposed or by FF actions



Understanding VAs and VPs

Vulnerable Points:

- Obvious road junctions or bends in roads
- High banked roads, culverts or bridges
- Choke points
- River, stream or wadi crossings
- Previous patrol routes.
- Previous and likely ICP locations and cordon positions
- Frequently used/obvious approaches to SF base locations
- Potholes or other known obstructions on roads, tracks or paths



Understanding VAs and VPs





Understanding VAs and VPs

VA Factors:

- Lines of Sight (LOS)
- Targetable patterns
 - Previously used routes
 - Frequently used positions
- Areas that afford the EF an easy escape route
- Roads which are canalized.
- Civilian Patterns of Life





ANY QUESTIONS?



VP/VA Pneumonic

- Channelled
- Aiming Marker
- Ground
- Environment



Am I being Channelled?





Are there possible Aiming Markers?





Ground





Environment Atmospherics





Summary

When deciding where to place an IED to target you, the Enemy will consider the location where he thinks he will have the greatest chance of success. Points where your movement is forced to slow down or is channelled by the environment will increase the Enemy's chance of success and therefore it is more likely that you will be targeted in these locations. All personnel should be able to safely conduct the application of 5/25s.



Look forward to...

CAGE & CMSA



All Arms Search Course

CAGE & CMSA



Range

- Time
- Safety
- Questions
- Notes
- Phones/Devices
- Food/Drink
- Previous knowledge
- Assessment



Module Objective

At the end of this module, the participants will be able to identify IED Indicators (CSMA) and understand how they must conduct their own personal threat assessment in Peace Support Operations.



Teaching Points Covered

- Introduction of CAGE
 - Channeling
 - Aiming Markers
 - Ground
 - Environment / Atmospherics

- Introduction to CMSA
 - Colours
 - Markers
 - Shapes
 - Atmospherics

- Discussion and Practical Display of CAGE/CMSA elements



Ongoing Threat Assessment

- Situational Awareness
- Route of own choosing?
- Identifying VA/VPs



Ongoing Threat Assessment

Intent

(What is the insurgent trying to achieve?)



Capability

(What type of device?)

Opportunity

(Where/When will
the device be located?)

Threat Assessment =

5Ws

- Who & Who
- Why
- What
- Where
- When



Vulnerable Points / Areas

Vulnerable Points

‘VPs are points along a route where it is advantageous for the Enemy to initiate an attack using IEDs, Small Arms Fire (SAF) or both.’

Vulnerable Areas

‘VAs are those areas where a target (you) can be predicted to be, but where no specific point offers obvious advantage’



Possible VP Locations

- Obvious road junctions or bends in roads
- High banked roads, culverts or bridges
- Choke points
- River, stream or Wadi crossings
- Previous patrol routes.
- Previous and likely ICP locations and cordon positions
- Frequently used/obvious approaches to SF base locations
- Potholes or other known obstructions on roads, tracks or paths

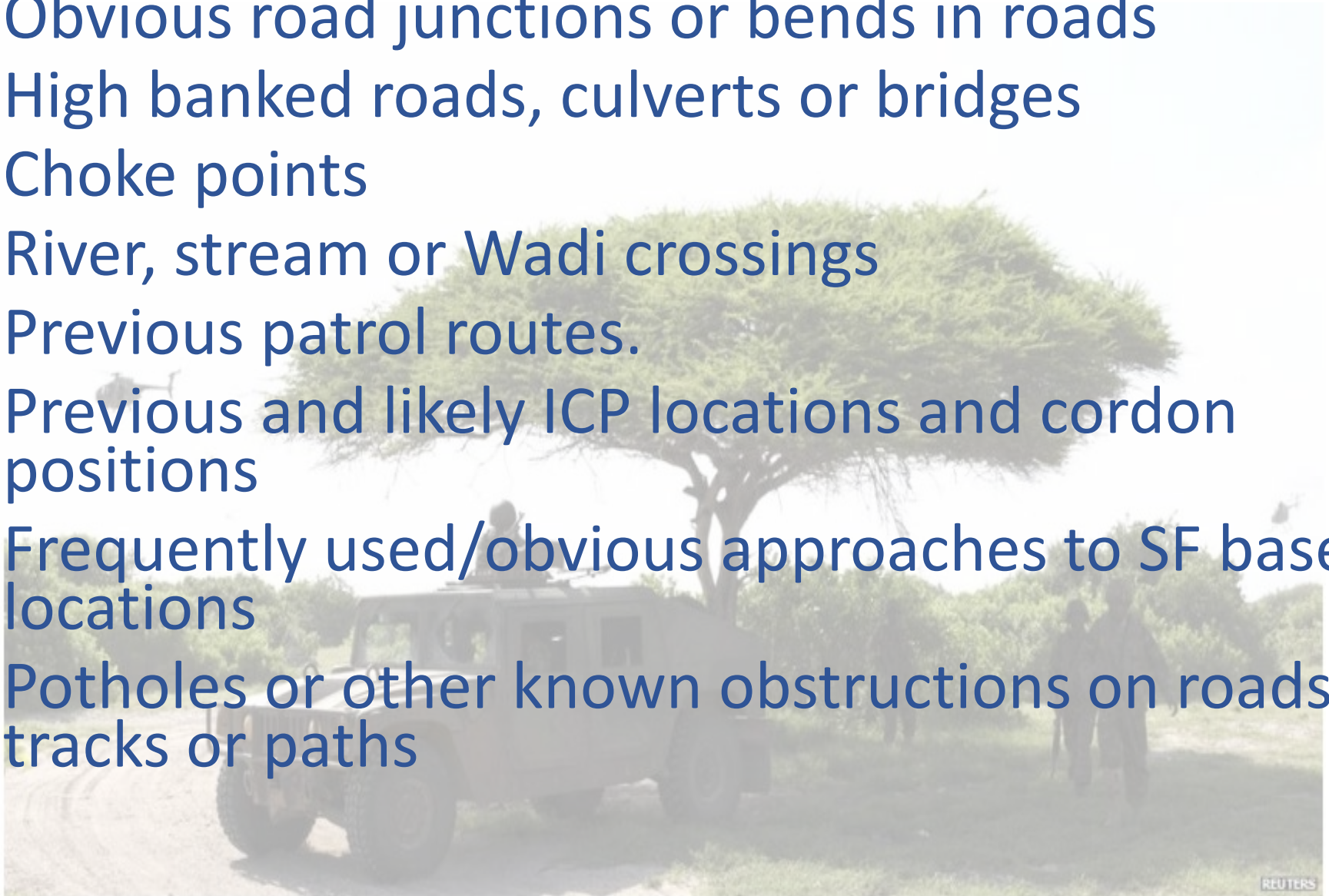



Introduction Of Cage

- Channelled
- Aiming Marker
- Ground
- Environment



Introduction to CMSA

What does the Pneumonic CMSA stand for?

C Colours

M Markers

S Shapes

A Atmospheric



Colours

Red Det Cord





Markers

In-place





Markers

Improvised





Shapes

Shapes

Linear Features

New/Disturbed Earth

Command Wires

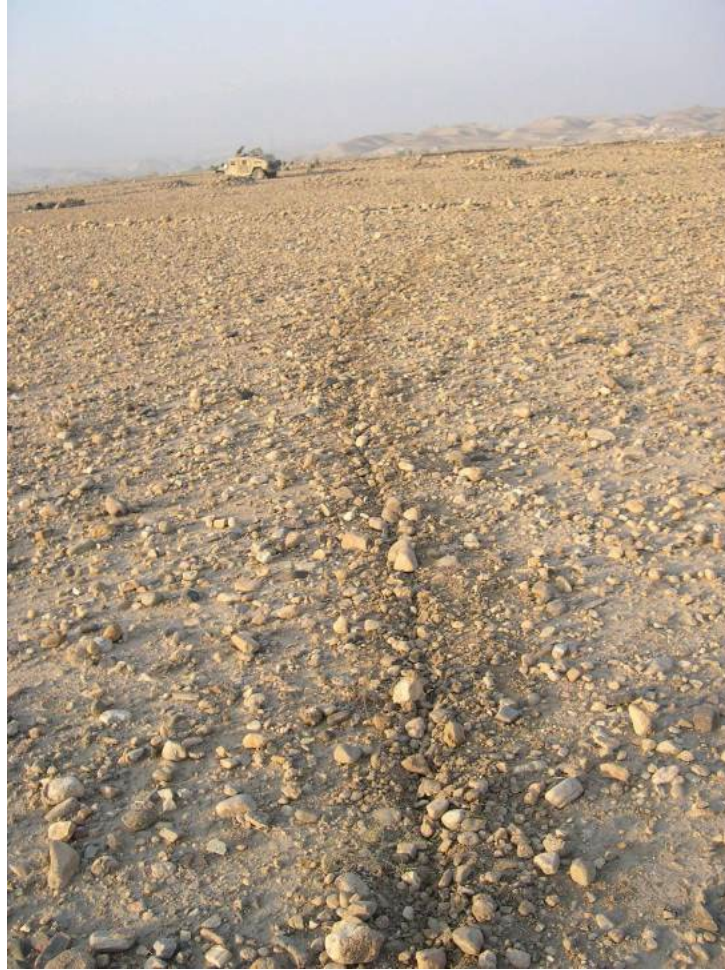



Atmospherics

Atmospherics





Absence of the Normal
or
Presence of the Abnormal?



End of Teaching Points

ANY QUESTIONS?



Questions

What does the Pneumonic CAGE stand for?

- C Channelling
- A Aiming Markers
- G Ground
- E Environment

What does the Pneumonic CMSA stand for?

- C Colours
- M Markers
- S Shapes
- A Atmosphericics



Summary

Identification of UXO and IED Combat Indicators is a component of C-IED Threat Assessment. A knowledge of Combat Indicators, and in particular the likely Colours, Markers, Shapes and Atmosphericics that may indicate the presence of an IED, are important skills that will contribute to effective personal Threat Assessment.



End of Teaching Points

ANY QUESTIONS?



Look forward to...

MODULE 1.4 – Ground Sign Awareness



All Arms Search Course (AASC)

Module 1.4 Ground Sign Awareness



Range

- Time
- Safety
- Questions
- Notes
- Phones/Devices
- Food/Drink
- Previous knowledge
- Assessment



Module Objective

At the end of this module, the participants will be able to recognize and interpret the characteristics of sign and its importance in search operations.



Teaching Points Covered

- Why things are seen
- Methods of observation
- Definition and characteristics of ground sign
- General principles
- Factors effecting Sign
- Judging the age of the Sign



What is sign

Definition

Any evidence of change inflicted upon the natural state of the environment by the passage of man, animal or machinery



Why Things Are Seen

What are the seven S'?

Shape – Familiar shapes recognised easily, Contrast with natural surroundings

Silhouette – Object silhouetted against a contrasted background

Shine/Texture – Surface that contrasts with its surroundings

Shadow – Cast/contained

Spacing – Natural objects are never regularly spaced

Sudden Movement – The eye is attracted to movement

Signature – Thermal output of objects



Methods Of Observations

What are the two methods used to identify enemy locations?

Scanning – general & systematic examination of an area
IOT detects anything out of the norm

Searching – a thorough examination of specific features
in the area

Both require concentration & knowledge of both Why
Things Are Seen and the principles of camouflage &
concealment



Methods Of Observation

Scanning

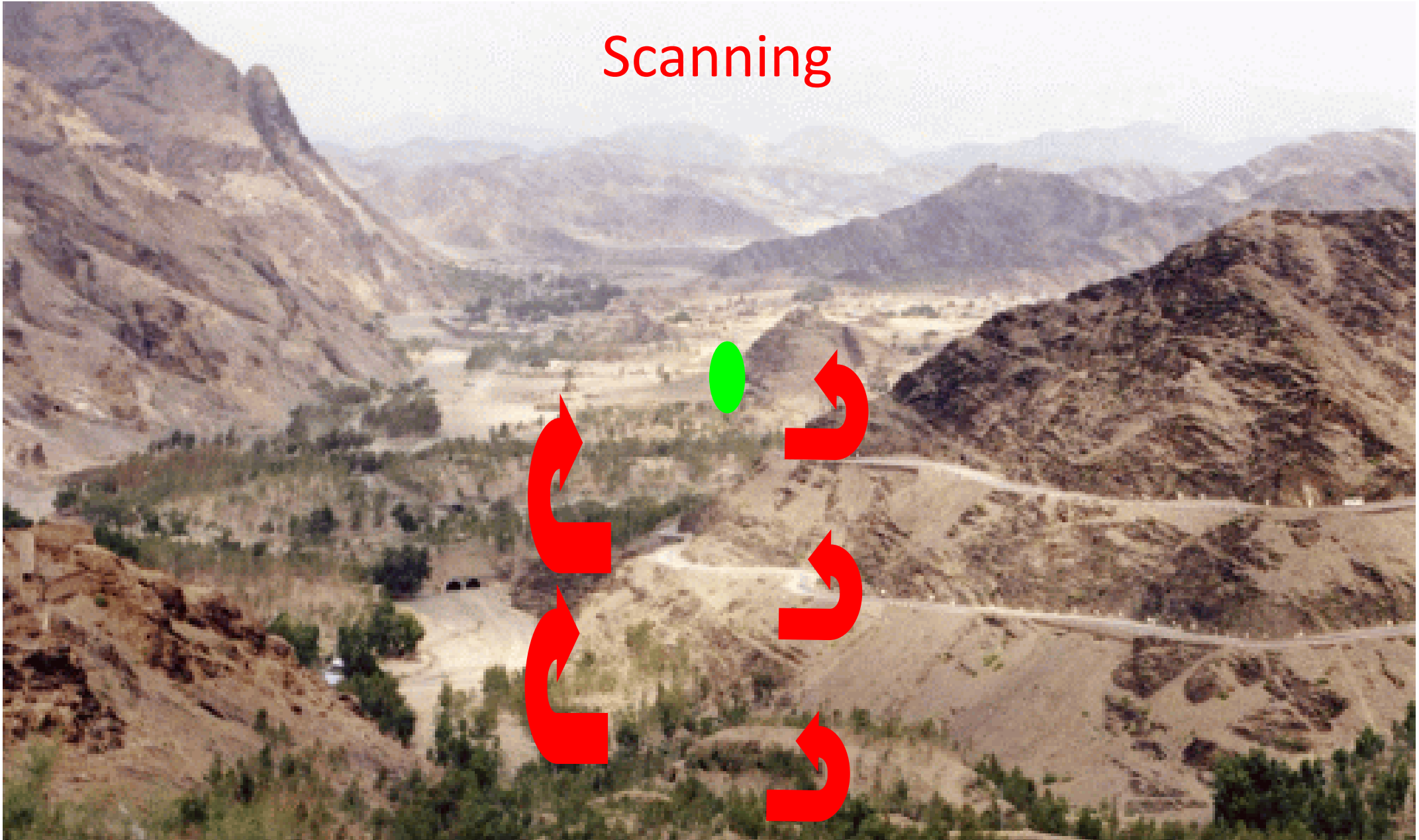



ANY QUESTIONS?



Introduction to GSA

The ability to identify and interpret ground signs is an element of tracking however it is a basic fieldcraft skill that all soldiers should possess. Soldiers should be able to use any means to gain as much information about the enemies' methods and where possible identify changes to the environment that can provide a combat indicator to preempt a dangerous situation.



The Utility Of GSA

- A set of tracks tells a story
- The interpretation of the ground sign, leading to immediate-use intelligence
- Tracks are clues as conclusive as fingerprints



Six Characteristics Of Ground Signs

Regularity

Flattening

Transfer

Colour Change

Disturbance

Discardables



Regularity

Regularity is an effect caused by:

- Straight Lines
- Arches
- Other geometric shapes

N.B. Shapes are not normally found in nature!

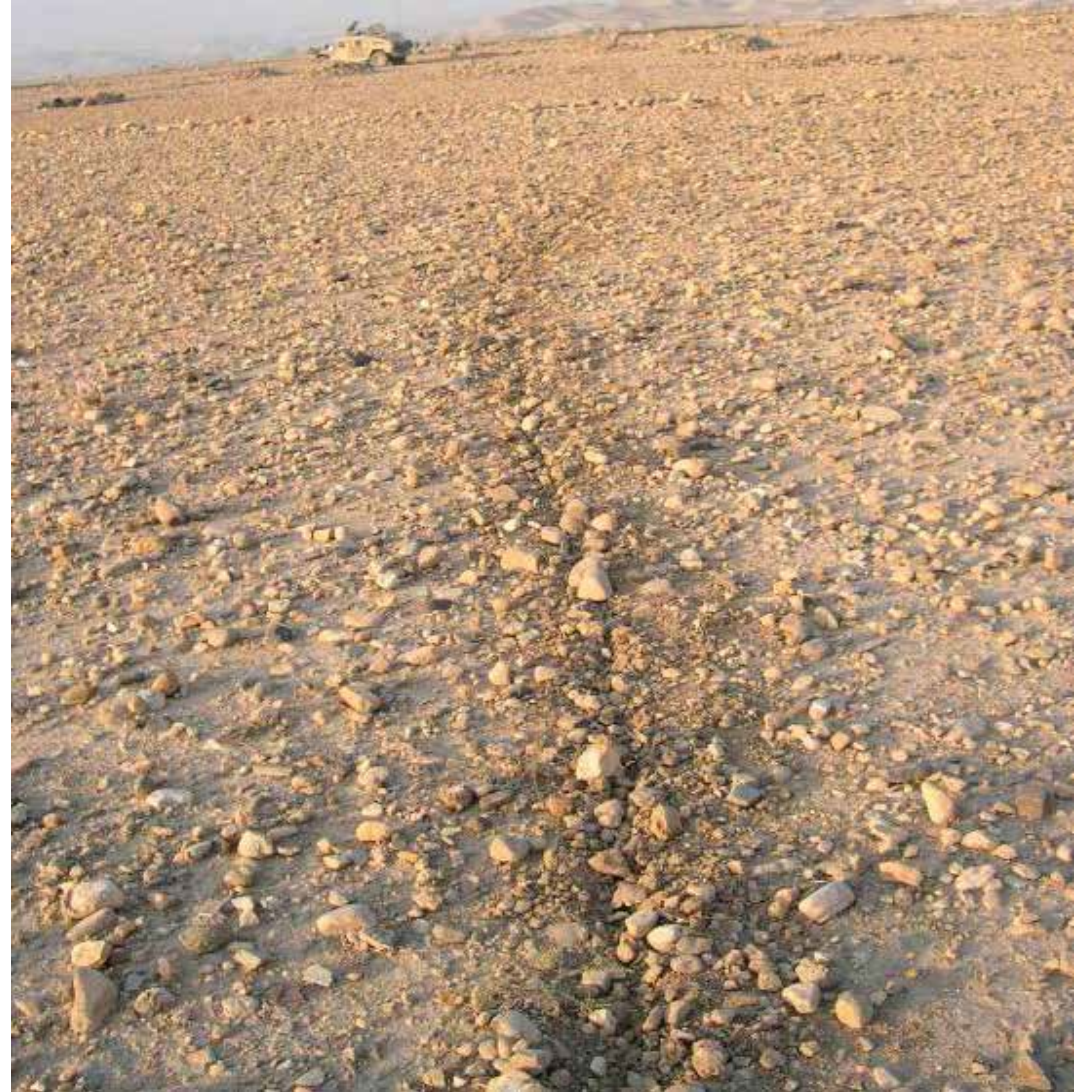



Regularity





Regularity





Flattening

Flattening is the general levelling or depression, identified by comparison of the immediate surrounding.

Where a device may have sunk



Where the earth has been patted down





Flattening





Flattening





Flattening





Flattening





Transfer

Transfer is the transit of materials from one environment to another

- Mud
- Sand
- Grass
- Water
- Leaves





Transfer





Transfer





Transfer





ANY QUESTIONS?



Colour Change

The difference in colour or texture from the area that surrounds it:

- Where earth has been dug up and is moist
- Where the ground has been smoothed to disguise the evidence of digging
- Where water, diesel etc has been used to camouflage the device





Colour Change





Colour Change





Discardables

Any materials that can be confirmed as belonging or attributed to the enemy:

- IED Components
- Rations
- Packaging/Rubbish
- Ammunition
- Weapon associates
- Personal Equipment





Discardables





Disturbance

Any evidence of change or rearrangement from the natural state caused by the passage of the target

- Insects
- Animals
- Leaf litter
- Foliage
- Soil
- Bruised roots





Disturbance





Disturbance





Disturbance





General Principles of GSA

- Direction of travel
- Numbers being tracked
- Age of the track
- Speed and load
- Rations being used
- Types of weapons carried
- Tactics employed
- Habits / Routine
- Sex of target
- General health



ANY QUESTIONS?



Factors Affecting Sign

There are four main factors that affect Ground Sign, and they are all very closely related. This can result in both advantages and disadvantages.

Sign (spoor)

Terrain

Climatic conditions (including snow)

Time



Animal spoor.

A sign left by an animal is known as Spoor. The soldier must consider the animal life in the area and know how to differentiate animal and human signs.



Sign and Spoor





Other Human sign

If other humans sign in the area, the ability to identify the normal from the abnormal activity



Sign and Spoor





Terrain

Grassland

Rocky country

Primary Jungle

Scrub/Secondary Jungle

Wetlands – Marsh, swamp, mangrove

Sand



Terrain

Grassland

- Pointers
- Colour contrast
- Dew
- Transfer
- Dry grass
- New grass
- Short grass





Terrain

Rocky Terrain

- Rolling stones (colour change)
- Scratches/chips
 - Sandstone – boot marks dark
 - Lava – boot marks light
 - Brittle rock – stone chips
- Stones on soft surface – pressed in
- Transfer of particles
- Moss - dislodged

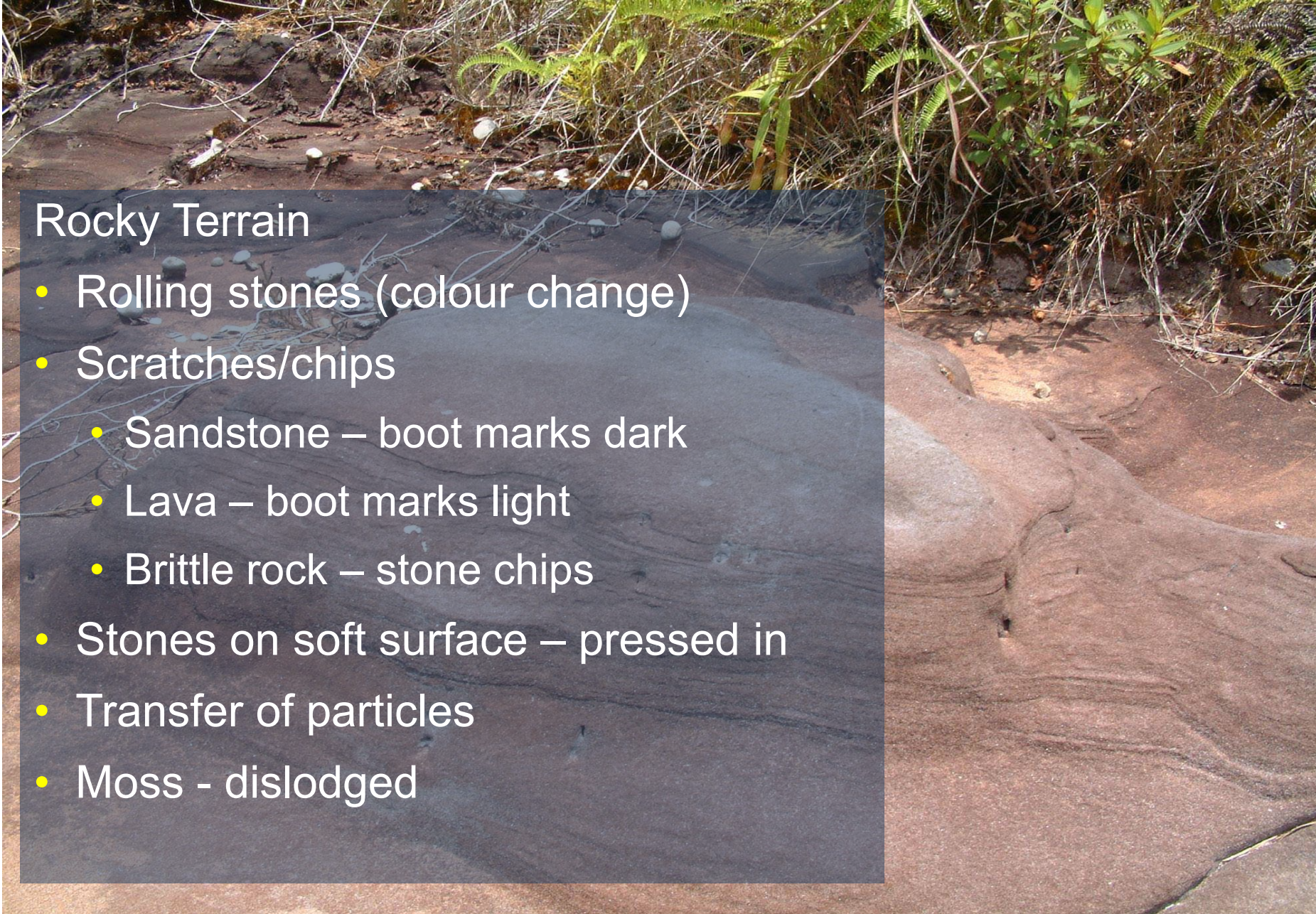



Terrain

Primary Jungle

- Wet leaves
- Dry leaves
- Dead/brittle leaves
- Top sign
- Broken twigs
- Rotten wood
- Fallen logs
- Bruised roots
- Broken cobwebs

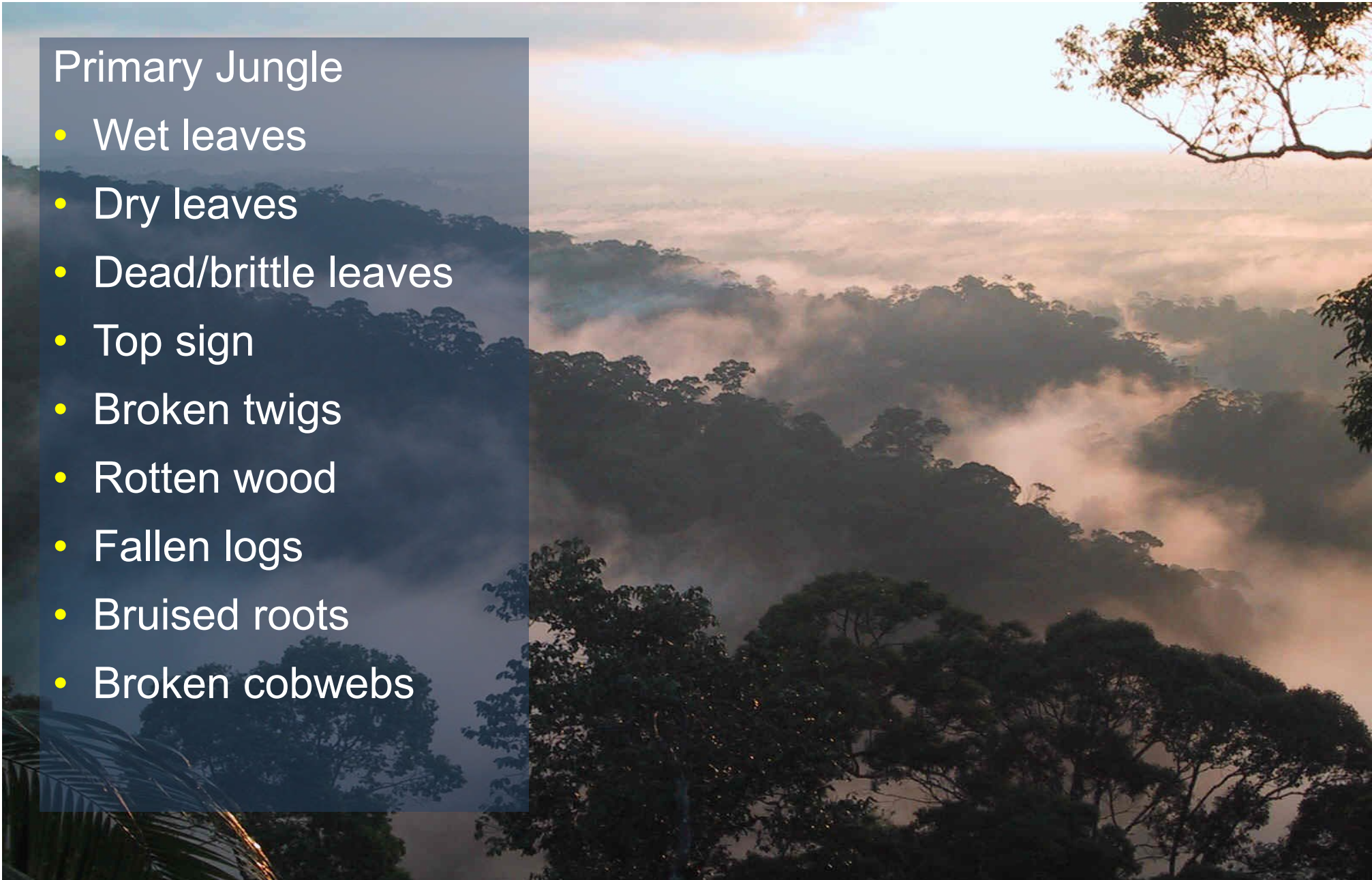



Terrain

Wetlands (Coastal & Estuarine Jungle)

- Footprints
 - Banks
 - Shallow water/mud
- Discoloured water
- Transfer
 - Water
 - Mud/sand
- Crossing points – boots taken off?
- Mangrove swamps
 - Mud stirred up
 - Bent branches where used for support

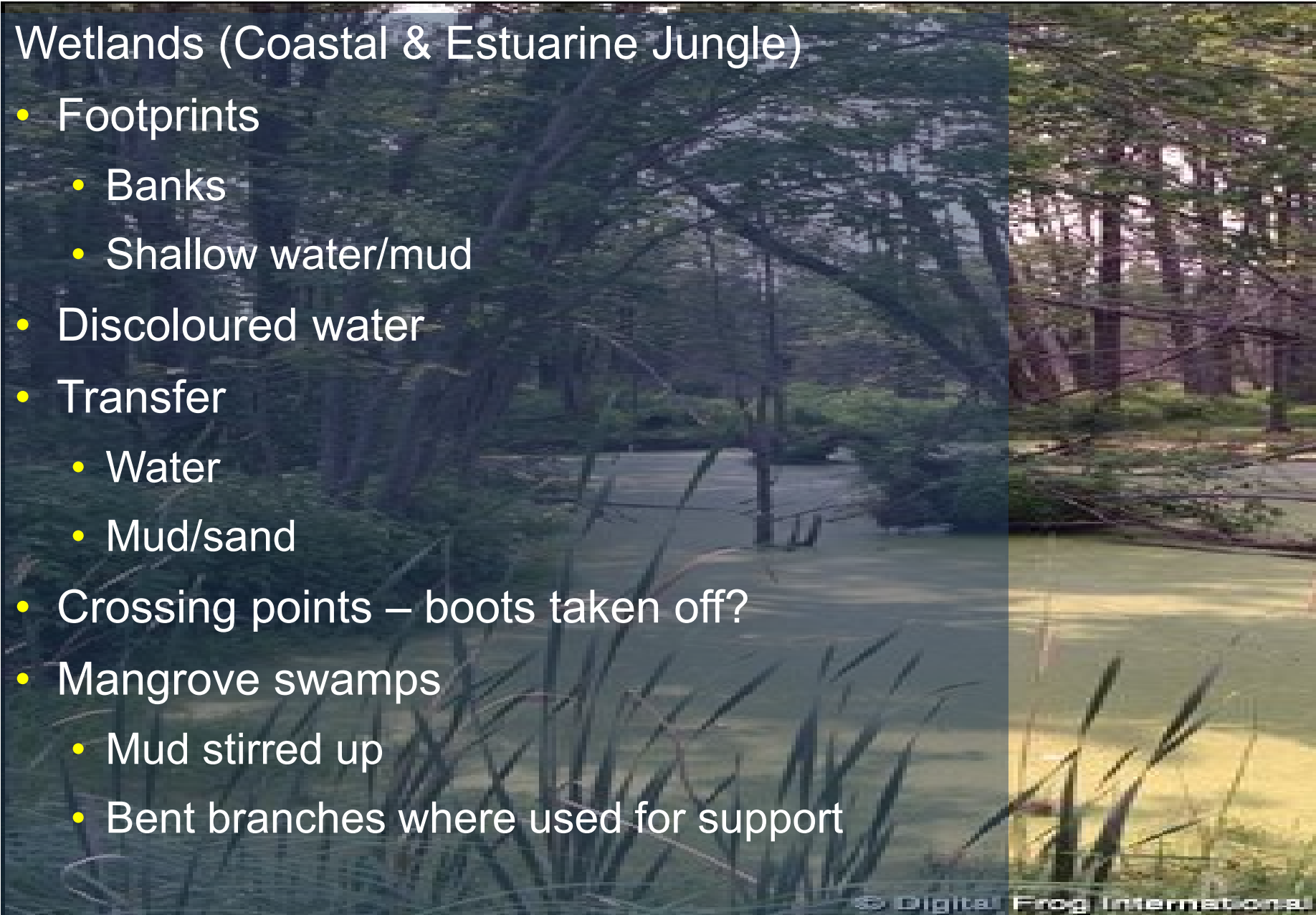



Terrain



Sand

- Hard/damp sand – very clear
- Soft sand – deep
- Wet sand – Soon returns to natural state



Climate Conditions

Direct sunlight

Heat

Contained shadow

Strong wind

Disturbed vegetation

Leaf litter

Heavy rain

Washes away ground sign

Reduces light

Ages sign

Snow



Time

To be able to assess the time between when the sign was first made and when it was located is the hardest part of the task.

Full details are covered within EOT 3- Judging the age of sign, however, experience and practice will help to overcome this difficulty.

Obviously the longer the period since the sign was laid and the time of discovery the more chance there is of the sign becoming fouled or flawed by climatic conditions and as a result the harder the sign will be to locate.



Other Considerations

Animal life

Noise

Disturbed insects

Foul Sign (caused by animals)

Look for likely exit point

Isolating

Sign in Built-up areas (Villages, Roads etc)

Knowledge of Track Traps

Look at the Sign Pattern



Judging the age of sign

For a GSA soldier to be able to judge the age of sign encountered and fulfil the role of an intelligence-gathering asset, he must be able to judge the age of sign accurately.

This will only come with experience and continual practice





Consideration needed to judge Age of Sign

Type of Sign

Hard Sign

Soft Sign

Exposure

Weather



Type of sign – Hard Sign

Hard Sign - Examples of hard sign include:

Marks in sun-baked soil

Marks on stones

Marks in resilient mosses or tussock grass.

Discardables such as plastic or metals

Hard sign takes longer to either deteriorate or return to normal than soft sign so can be identified for longer.



Type of sign – Hard Sign

Sun Baked Soil





Type of sign – Hard Sign

Resilient Mosses





Type of sign – Hard Sign

Plastics or Metals





Type of sign – Soft Sign

Soft Sign – Examples of soft sign include

Marks in soft soil, mud, or sand

Marks inflicted upon green leafy plants

Food discardable such as rice

Soft sign will deteriorate or return to normal more quickly than hard sign, therefore, you will know that if you are identifying soft sign then you are closer to the enemy.



Type of sign – Soft Sign

**Marks On Green
Leafy Plants**





Type of sign – Soft Sign

Food Discardable





Sign impacted by its exposure

Exposure

The degree of exposure to the elements will have differing effects on the sign.

Exposure to direct sunlight and heavy winds sign will change rapidly (return to normal/age) which must be taken into account.

In exposed areas there may be minimal signs and any sign found is likely to be fresher than it appears.



Sign impacted by its exposure





Sign impacted by the weather

Weather

The condition of the sign will be directly connected with the climatic conditions it has been subjected to. You will know if the track was laid before or after heavy rain or showers.



Sign impacted by the weather

Post Rain





ANY QUESTIONS?



How to judge the age of the Sign

Comparison of colour

Comparison of impression

Bracketing

Local knowledge of fauna/flora



Comparison of colour

Compare the colour of sign in relation to colour of the surrounding area

Cracks in bent leaves/grass



Breaks in sticks/twigs





Judging the age using bracketing

- Weather - Time of rain/Overnight dew/Strong winds





Judging the age using pattern of life

- Game Sign superimposed - Animal and human pattern of life / Active at night





Local knowledge of flora & fauna

Vegetation





Local knowledge of flora & fauna

Insects





ANY QUESTIONS?



Questions

What are the 6 characteristics of Sign and describe them?

What methods can be used for judging the age of Sign?

What factors have an effect on sign?



Summary

Minimal skill fade of ground signs is important for individual threat assessment in AO. Patience & tuning in while in Ops area for the soldiers, this is not an immediate skill. Soldiers must continuously be proactive looking for Sign, doing so will make it second nature, remember from your other lessons, presence of the abnormal and absence of the normal.



References

The following references are available to support this module:

- CJTF – 7 (January 2004). OIF Smartcard Version 1.A. Retrieved from: <https://fas.org/irp/doddir/army/iedsmartcard.pdf>
- Diaz, D., McCann, V. L. (2005). Tracking Signs of Man, Signs of Hope . A systematic Approach to the Art of Tracking Humans. USA
- Donelan, S. (1988). Tactical Tracking Operations: The Essential guide for military and police Trackers. Colarado – USA
- Multi-National Corps (2004). Improvised Explosive Devices, Smart Cards: ASOF27OCT2004. Iraq
- UNDPKO/DFS Guidelines (2016). Improvised Explosive Device (IED) Threat Mitigation in Mission Setting. Newyork: Author
- UNMAS, GICHD (2003). Mine Action and Explosive Hazard Management: Humanitarian Impact, Technical Aspects, and Global Initiatives. Geneva, Switzerland: Author
- UNMAS (2018). United Nations Improvised Explosive Device Disposal Standards. Document Reference no. 2018.05. NewYork. USA: Author



Look forward to...

Module 1.5

Threat Assessment



All Arms Search Course (AASC)

Module 1.5

Threat Assessment



Range

- Time
- Safety
- Questions
- Notes
- Phones/Devices
- Food/Drink
- Previous knowledge
- Assessment



Module Objective

At the end of this module, the participants will be able to assess the different threats that will compromise operations in PSO.



Teaching Points Covered

- Introduction to Threat assessment
- Initial Planning
- Factors to consider
- Source of information and intelligence
 - Maps
 - Historical Data
 - Enemy intelligence
 - Human terrain analysis
- Threat triad
 - Enemy intent
 - Enemy capability
 - Ground
 - Threat summary



Threat Assessment

Introduction

- C-IED Threat Assessment is a relatively simple process that allows us to fuse the output Intelligence analysis with knowledge of the local environment and also knowledge of Enemy Force (EF) IED capability.
- This allows us to make an assessment of the potential IED threat posed during any given operation or operational phase.



Threat Assessment

1. Initial Assessment (Mission Planning)
2. Ongoing Assessment (On Patrol)



PLANNING

Planning Responsibilities

–Search Coordinator

- Overall risk assessment
- Identification of appropriate assets

–Search Advisor

- Specific risks
- Procedural counter-measures



Search Co-ordinator

- Provide tasking advice to Formation/Unit Commander
- Co-ordinate Search Operations
- Maintains Search Records and Database
- Acts as the Search focal point for supporting agencies and subordinate coordinators/advisors
- Monitors continuation training and quality of documentation.



Search Advisor

- Provide tactical advice to Incident Commander
- Plan Search Operations
- Control Search Operations
- Plan and conduct continuation training
- Administer Search Teams



The Threat Triad

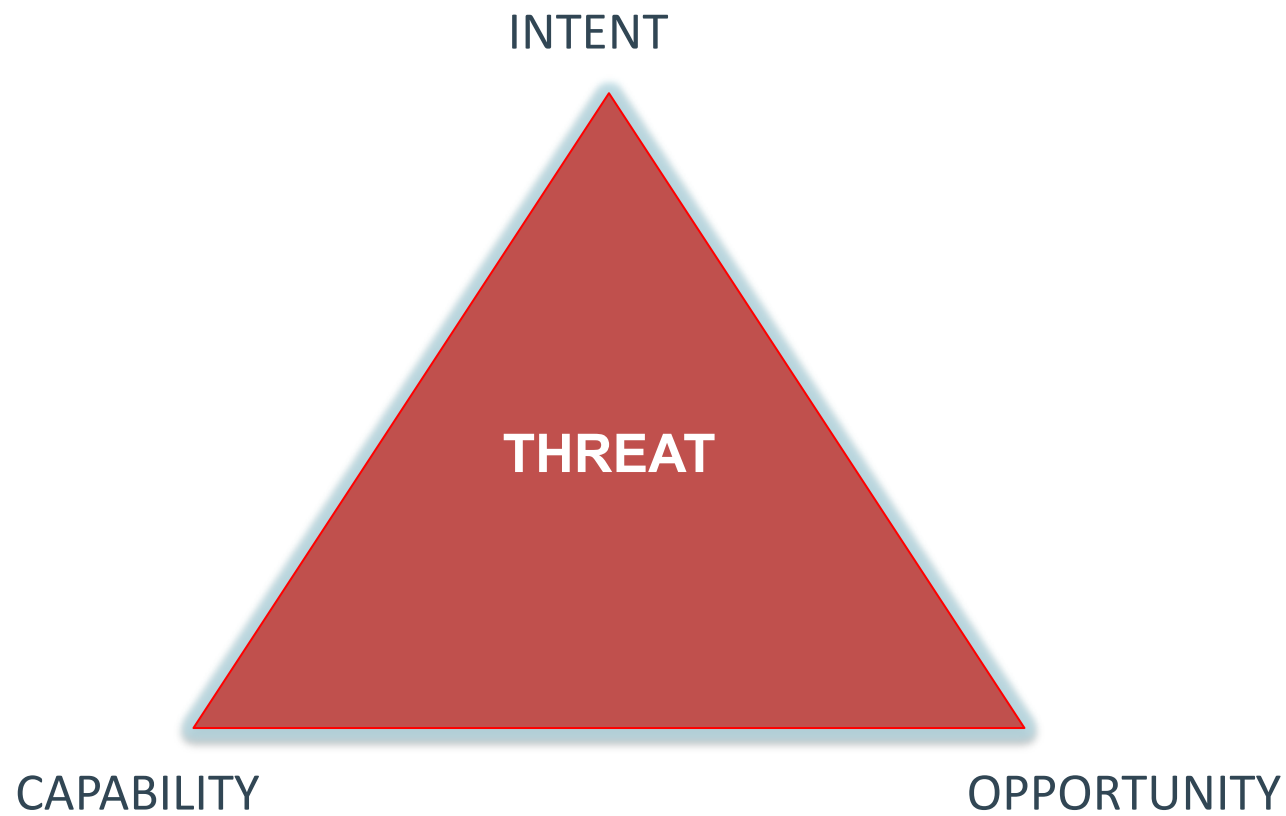



Enemy Intent

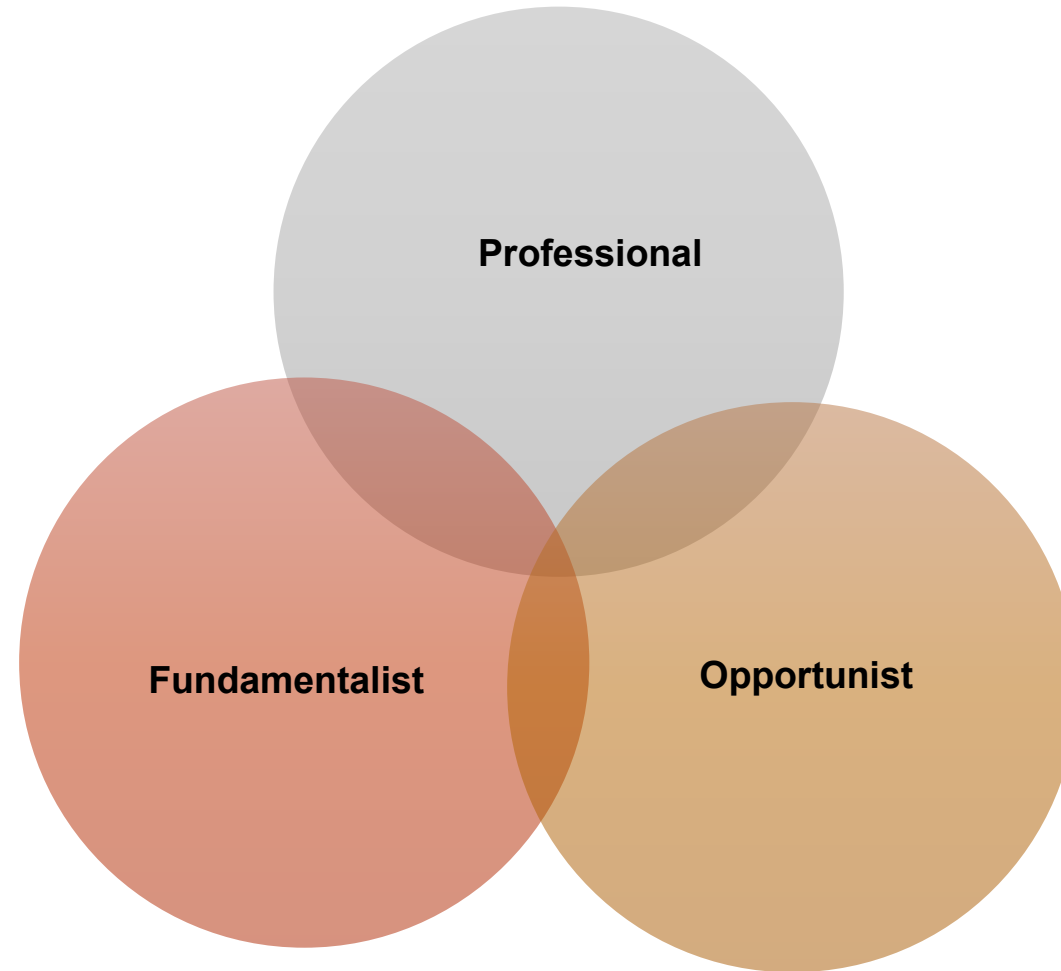

Who is the enemy?



Initial Planning

- Ground
 - Locations
 - Aerial Imagery/Satellite Imagery
 - Maps & Plans
 - Extraordinary features



Factors to Consider

- Locations
 - Location of search including boundaries
 - Previous searches in the same area
 - Local or known terrorist personnel
 - Possible Contact & Firing points



Aerial Imagery/Satellite Imagery





Maps & Plans

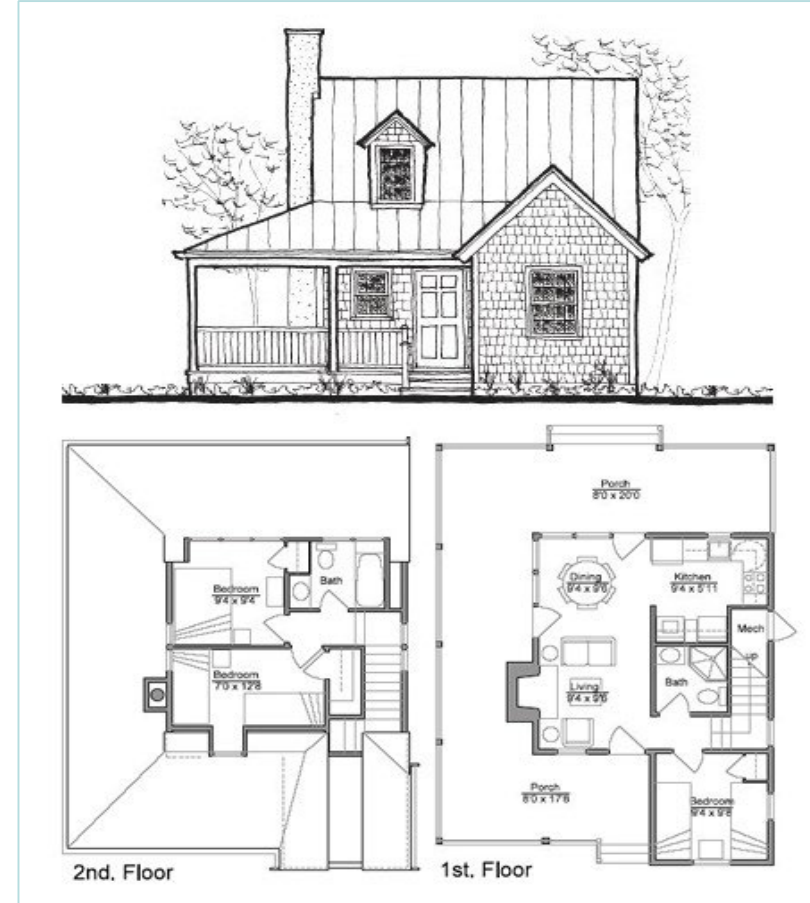
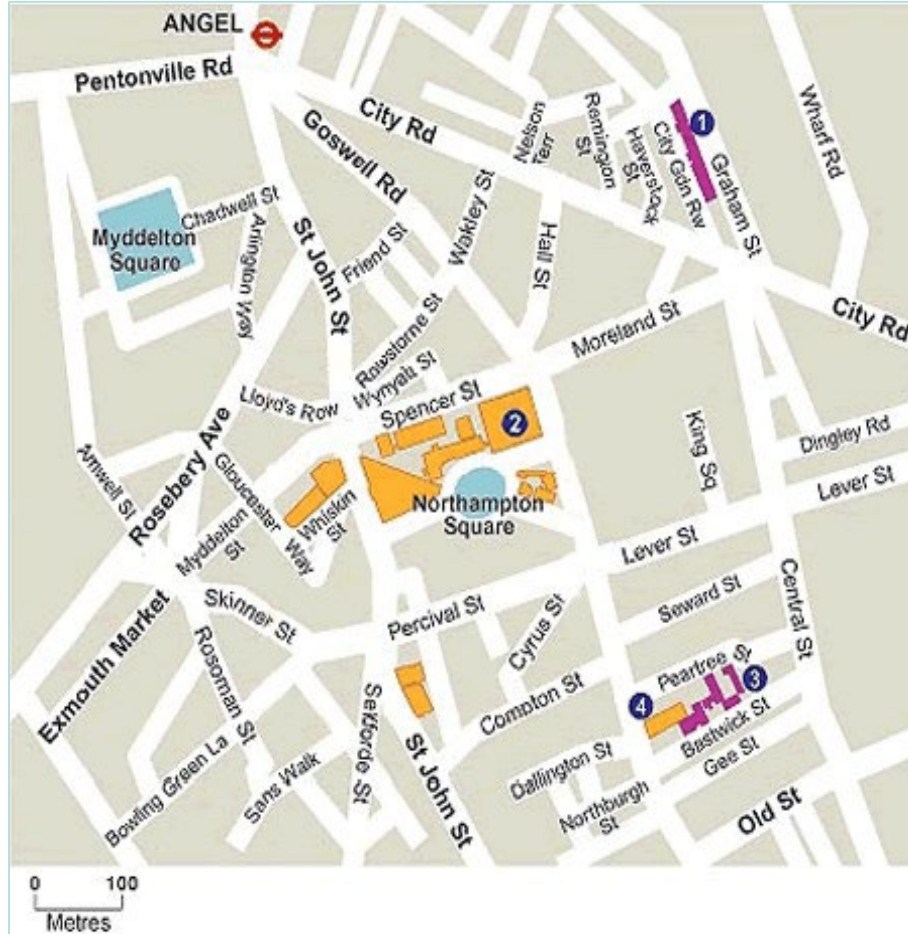



Extra-ordinary features

- Ponds/Slurry Pits
- Industrial & technical Areas
- Farms
- Wells
- Rivers & Streams



Factors

- Factors which may be considered:–
 - Routes of the VIPs or SF
 - Defiles and avoidable routes
 - Channeling of potential targets
 - Concealment potential for the terrorist
 - Structural analysis of buildings
 - Routes
 - Means of travel
 - Explosive effects
 - Weather/going.



ANY QUESTIONS?



The Threat Triad

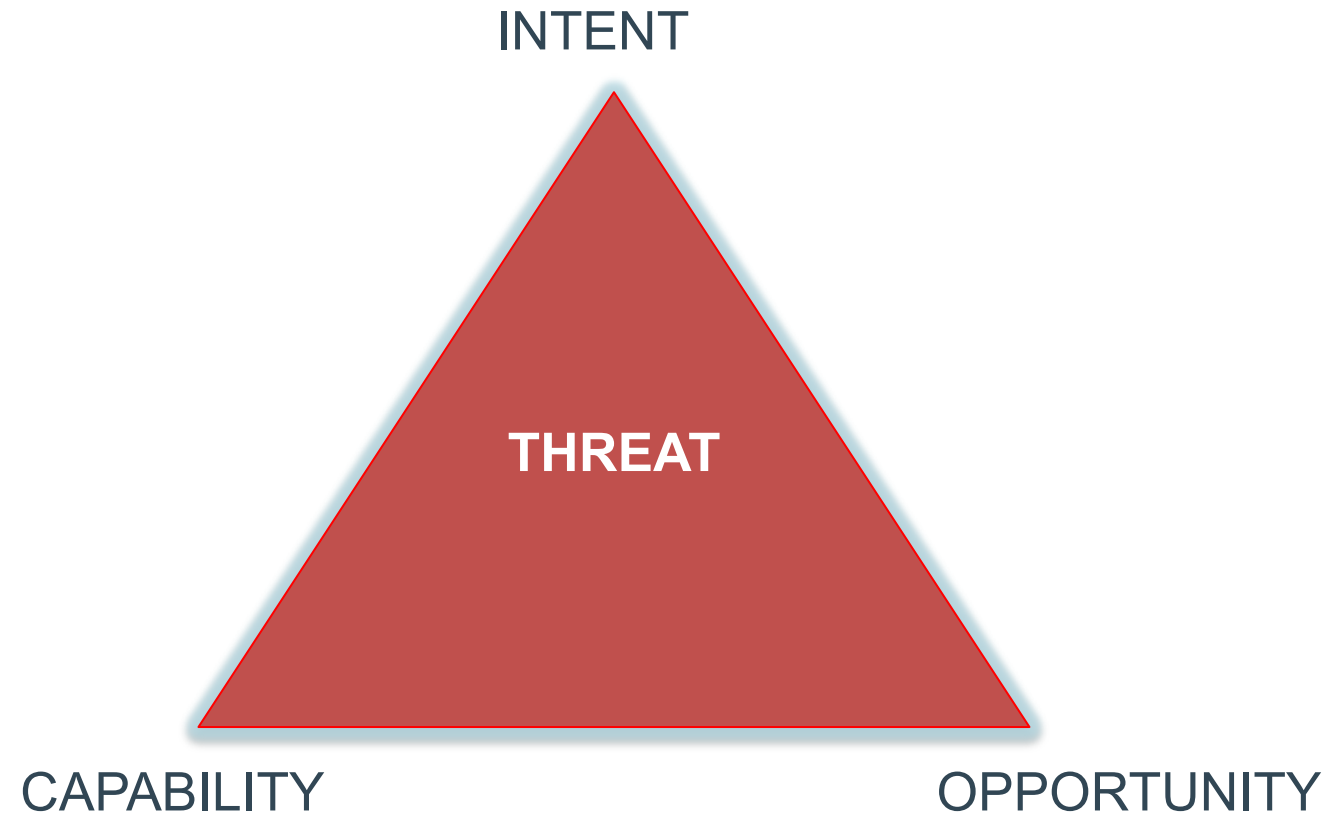



Terrorist Intent

- What are they trying to achieve?
- What training & equipment do they have?
- Where is the best place for them to strike?
- Who/what is the target?
- What are they capable of achieving?



Enemy Capability



What type of device will they try to use and how will it be initiated?

- What capabilities do they have in theatre?
- What training & equipment do they have?
- What assistance are they getting?
- What are they capable of achieving?



Enemy Capability

Consider Type of Device and Means of Initiation:

- Time IED
- Command IED
- Victim Operated IED
- Projected Weapon/IED

Consider

- What has EF successfully used?
- What is he capable of using?
- What resources does he have access to?



Enemy Capability

Time





Enemy Capability

Time

Are you presenting ideal targets for a timed attack?

- Static targets such as SF bases with ease of access to EF?
- Patrols/activities that happen at the same place and time each day/week?

Consider the options, in line with EF capability, intent and resources

Consider Countermeasures



Enemy Capability

Command





Enemy Capability

Command

- Are you presenting frequent and trackable targets (either mobile, on foot or static targets) that EF can easily engage with command IEDs?
- Think of your posture – are you high profile and fairly inflexible in the routes you use?

Consider Countermeasures.



Enemy Capability

Victim Operated (VO)





Enemy Capability

VO

Are you setting exploitable patterns in any way?

- Using the same
 - Routes
 - Entrance/exits
 - SOPs etc.

Nearly any pattern you set is exploitable by a
VOIED

Consider Countermeasures



Enemy Capability

PROJECTED





ANY QUESTIONS?



Opportunity

Use of ground –Vulnerable Points/Areas



Where will the device be located & why?



Opportunity

- **Vulnerable Points**

‘VPS are points along a route where it is advantageous for the Enemy to initiate an attack using IEDs, Small Arms Fire (SAF) or both.’



Opportunity

Terrain Oriented VP

A terrain orientated VP/VA is where the ground offers a particular advantage

Situationally Oriented VP

An adversary may use friendly force patterns or predictable actions/responses to mount an attack at a specific point. It may be difficult to fully understand the adversary's intent during planning; where this is the case, Advanced Search assets should be tasked or advice sought from a Search Advisor.



Opportunity

Vulnerable Points:

- Obvious road junctions or bends in roads
- High banked roads, culverts or bridges
- Choke points
- River, stream or Wadi crossings
- Previous patrol routes.
- Previous and likely ICP locations and cordon positions
- Frequently used/obvious approaches to SF base locations
- Potholes or other known obstructions on roads, tracks or paths



Opportunity





Opportunity





Opportunity

- **Vulnerable Areas**

VAs are stretches of route or areas that present significant advantages to an adversary wishing to mount an attack. The location will directly depend on the adversary's Freedom of Movement, capability and any limitations either self-imposed or by FF actions



Opportunity

VA Factors:

- Lines of Sight (LOS)
- Targetable patterns
 - Previously used routes
 - Frequently used positions
- Areas that afford the EF an easy escape route
- Civilian Patterns of Life



Opportunity

Routes dominated by high ground





Opportunity

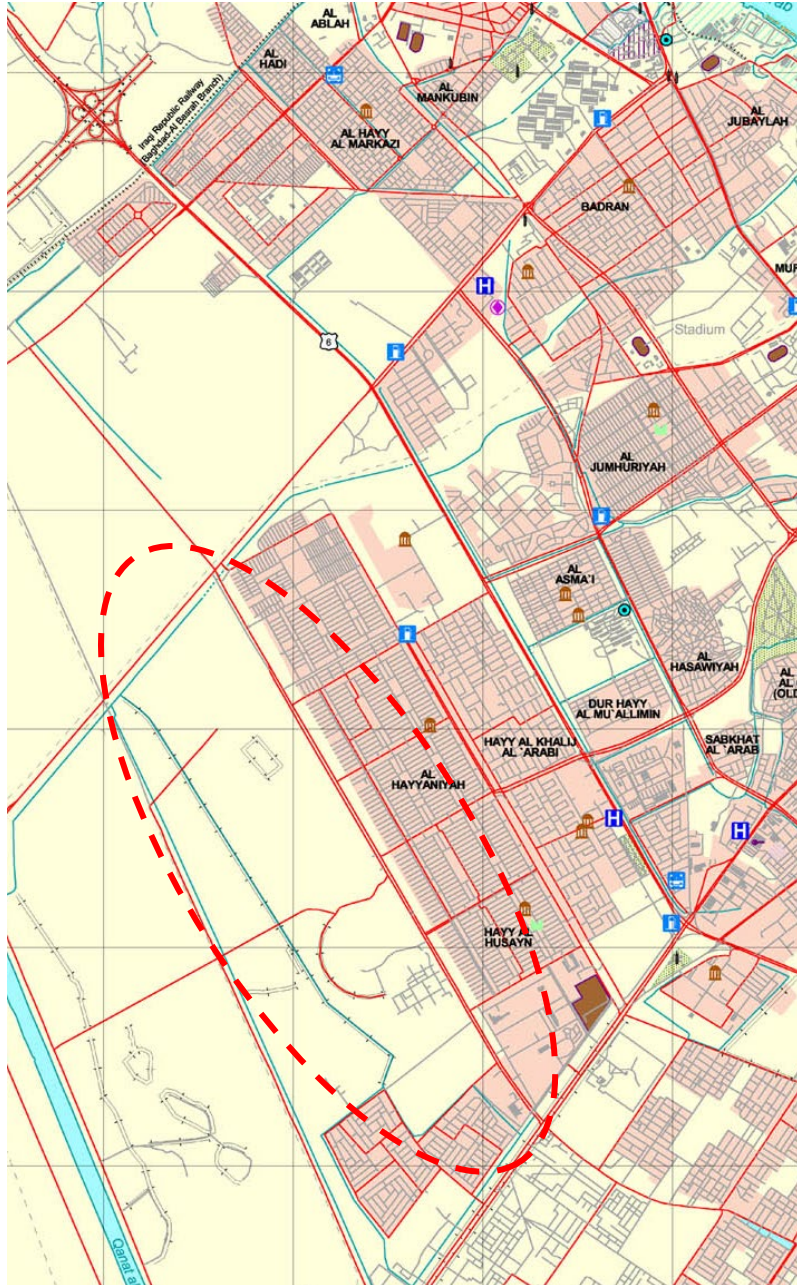



Location of the Threat/Ground

- Where is the threat most likely to be?
 - VPs/CPs





Threat Summary

- After investigating the Threat Triad, it is the Advisors job to produce the THREAT SUMMARY for the team/s
 - For Example:

The most likely threat is from religious extremists seeking to kill or maim Coalition Forces (CF) to undermine the security situation and affect morale through the use of prepositioned Command Initiated IEDs (most likely RC) with large blast or EFP charges at major intersections on the urban/rural interface



Threat Summary

- For Example:

The most likely threat is from insurgents seeking to kill or maim Friendly Forces (FF) protecting Rte PURPLE through the use of pre-positioned VOIEDs incorporating HMC switches and 5 kg MCs on junctions/Check Point areas. There is also a threat of a Long-Range Shoot onto the cordon.



Threat Summary

- The worst-case threat is that first responders will also be targeted through the use of Pre-positioned VO or Command Initiated IEDs with blast and fragmentation charges in likely ICP Locations.



ANY QUESTIONS?



Friendly Forces

- **FF (incl Close Serv Sp)**
 - Own force capabilities
 - Search teams available
 - Agencies available.





Factors for Search

- **Surprise and Security**

- Cordon requirements
- Electronic Counter Measures (ECM)
- Use of UAV
- Use of MWDs/Agencies/Atts/Dets
- Time on ground
- Other ongoing operations.



Factors for Search

Health & Safety





Factors for Search

Time

- Time required for the search
- Soak times
- Pre-search time:
 - Time constraints including legal restrictions
 - Time required by IEDD teams
 - Recovery and debrief time



Factors for Search

- Summary of possible tasks
- Considered Courses of Action
- Formulate your Plan



- **General Points**

- Must have carried out an element of your planning prior to the conference
- Must have conducted a Threat Summary
- United front with EOD/IEDD if involved
- Likely duration of task
- Assistance of cordon with the search.



General Points contd...

- Assistance of search for assets for the cordon
- Cordon timings for new flight
- Escorts - RV time and place
- Administration arrangements
 - accommodation
 - re-supply of batteries and water
 - faulty equipment
- Come away with all relevant timings



General Points contd...

- Use the Incident Commander to mediate when there are conflicts of interest
- When conducting Multi-National Operations remember OPSEC



Planned Operations Sequence

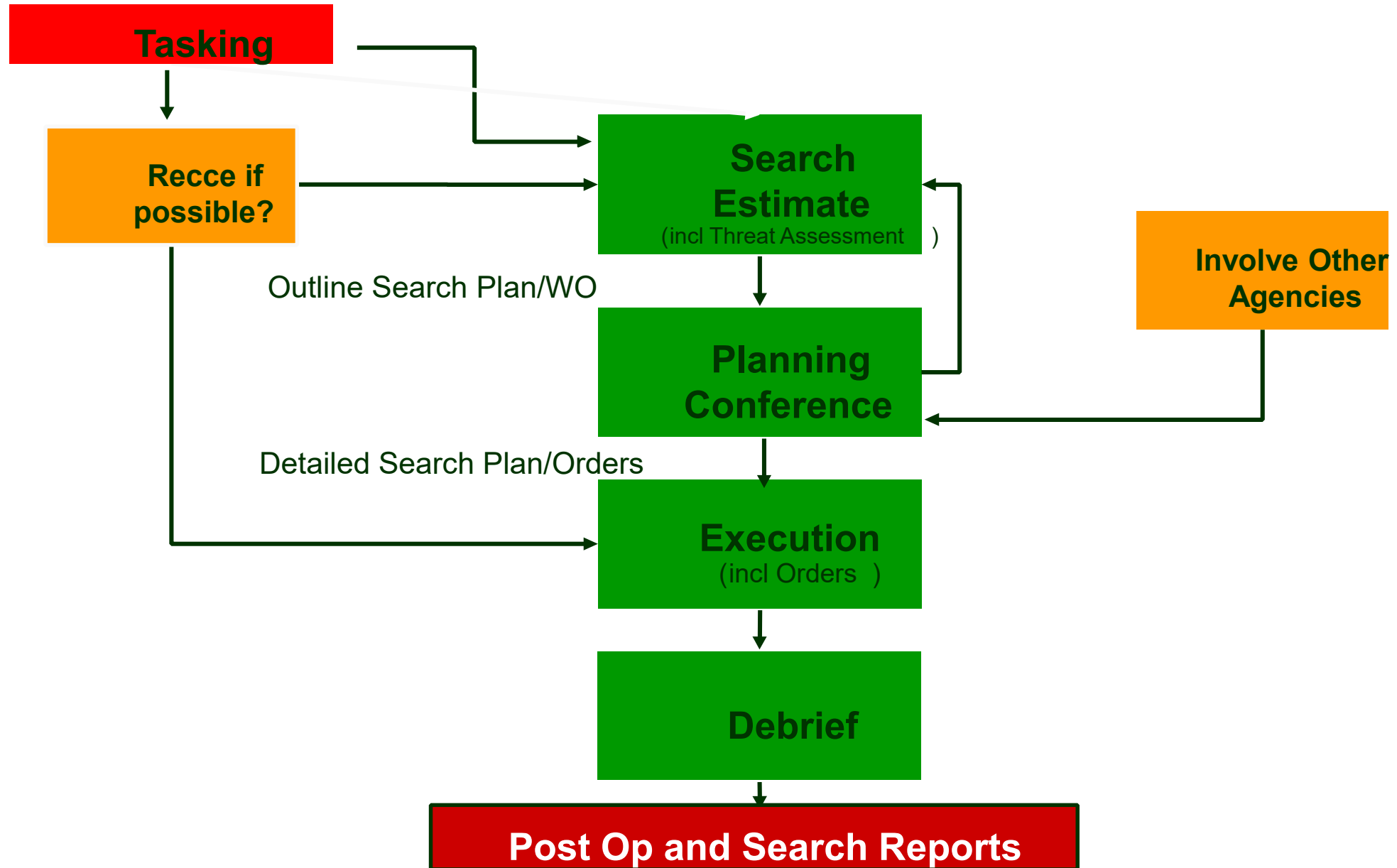



End of Teaching Points

ANY QUESTIONS?



Summary

Understanding the different threats that will compromise operations in PSO is key to a successful operation. The factors should not be ignored and as such should also involve IED planning being conducted throughout the operation. Failure to do so will result in more IED incidents and increased inactivity.



Look forward to...

MODULE 1.6 – Incident Reporting



All Arms Search Course (AASC)

Module 1.6 Incident Reporting



Range

- Time
- Safety
- Questions
- Notes
- Phones/Devices
- Food/Drink
- Previous knowledge
- Assessment



Module Objective

At the end of this module, the participants will be able to demonstrate the application of the 5Cs in responding to explosive hazard emergencies and how incidents should be reported.



Teaching Points Covered

- Introduce and explain 5Cs
 - Confirm
 - Clear
 - Call
 - Cordon
 - Control
- Incident Reporting



Teaching Points Covered Cont'd

- Key information in an incident report
 - 5 Ws & H
(Who, What, Where, When, Why and How)
- UN 10 liner
- Importance of information sharing



5Cs

- Confirm
- Clear
- Call
- Cordon
- Control



5Cs

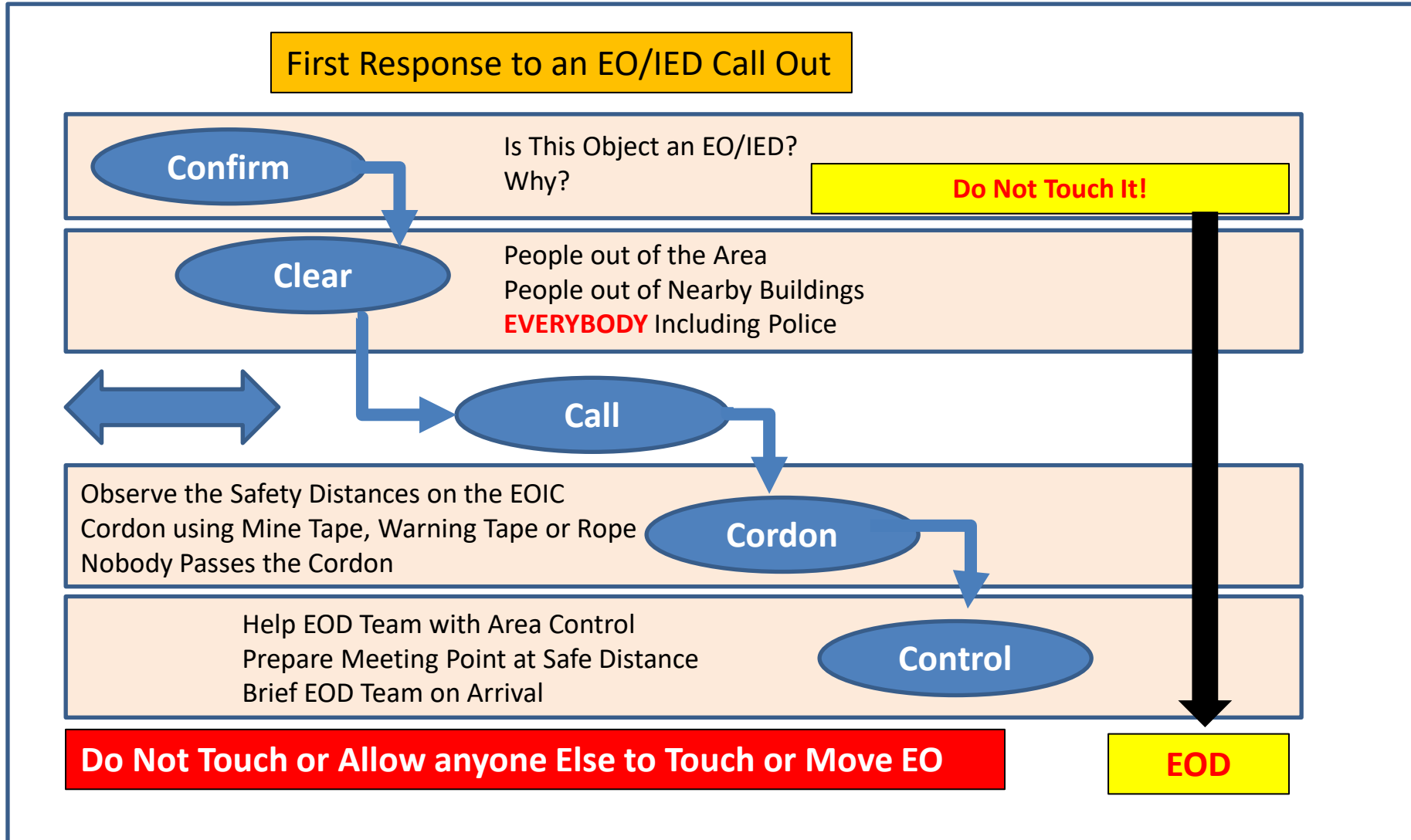



5Cs

Confirm:









- Visual
- From a Distance
- Never touch
- Look for
Secondaries
- Min numbers
- If unsure?
- Reporting





5Cs

Clear: Distance and Evacuation

 UNMAS		Evacuation Distance Guide		
Threats		Explosive Weights Kg/lbs	Min Evacuation Distance M/Ft	Suggested Evacuation Distance M/Ft
Pipe Bomb		2.3kg/5lbs	130m/430ft	375m/1200ft
Suicide Bomber		9kg/20lbs	150m/500ft	525m/1700ft
Briefcase/Backpack		23kg/50lbs	190m/600ft	575m/1900ft
Compact Car		230kg/500lbs	270m/870ft	600m/2100ft
Full Size Car		460kg/1000lbs	300m/1000ft	725m/2400ft
Van/SUV		1800kg/4000lbs	375m/1275ft	1160m/3800ft
Small Truck/Moving Van		4600kg/10000lbs	440m/1450ft	1560m/5100ft
Water Tanker		13600kg/30000lbs	525m/1725ft	2410m/7900ft
Semi Trailer		27200kg/60000lbs	575m/1875ft	2840m/9300ft

CALL EOD AS SOON AS POSSIBLE



5Cs

Call:

REPORTING AN EO/IED

INFORM YOUR SUPERIORS THROUGH THE CHAIN OF COMMAND



A	Priority for requesting unit	Immediate <input type="checkbox"/>	urgent <input type="checkbox"/>	routine <input type="checkbox"/>	no threat <input type="checkbox"/>
B	Priority reported by	1	Rank or position		
		2	Contact name		
		3	Unit identifier/Call sign		
		4	Contact method		
C	POC for further information	1	Rank or position		
		2	Contact name		
		3	Unit identifier/Call sign		
		4	Contact Method		
		5	Rendezvous location for EOR/EOD team		
D	DTG of EO/IED discovery	EO/IED was discovered			
E	Location / area of EO/IED	1	Grid Reference		
		2	Additional location info		
		3	Underwater	Yes <input type="checkbox"/>	No <input type="checkbox"/>
		4	Buried	Yes <input type="checkbox"/>	No <input type="checkbox"/>
F	EOD Identification estimate	What? How many? (use ID Guide codes)			
G	Safety measures undertaken	1	Evacuation distance in meters		
		2	Other protective measures taken		
H	Effect on operation	Totally disrupted <input type="checkbox"/>	major <input type="checkbox"/>	minor <input type="checkbox"/>	nil <input type="checkbox"/>
I	Other significant info				
J	Date and signature				

NEVER



- TOUCH, MOVE OR DISTURB THE EO/IED
- USE A MOBILE PHONE OR RADIO WITHIN 50 M OF THE EO/IED
- ALLOW **ANYONE** TO RE-ENTER THE CORDON
- GIVE INFORMATION TO CIVILIANS OR TO THE MEDIA



Cordon:

- Robust
- Safety
- Think forensics
- Manpower
- Routes
- Patrols
- Reinforcements





5Cs

Control:

Incident Control Point
(ICP)





ICP criteria:

- ICP should have a line of site to the incident
- ICP should have cover and hard protection if possible
- ICP should be of sufficient size:
 - EOD
 - Additional troops, witnesses
 - Police
 - Medical



ANY QUESTIONS?



Introduction to Incident report

When the presence of a probable IED has been confirmed, the commander should inform their higher command of the situation and request assistance. The assistant call must be preceded by 5Cs and be done as soon as possible

Depending on the AO one of 3 reporting methods will be used, UN 10-liner, 10 LINER or a simple 5 W&H.



Introduction to Incident report

- After an attack the incident commander has to win the firefight and secure his position
- He should order for attention to the injured personnel and any first aid applicable
- Clear any immediate enemy threat posed to the location
- Any checks on equipment for any damage incurred
- Element of concurrent activity to be carried out
- Exploitation of the scene should follow
- Submission of the incident report and controlling of the scene follows

REMEMBER... Not all IED incidents will occur through an attack, many IEDs are found these must also be reported



Action on IED Find – Call – UN 10 LINER

REPORTING AN EO/IED

INFORM YOUR SUPERIORS THROUGH THE CHAIN OF COMMAND



A	Priority for requesting unit	Immediate <input type="checkbox"/> urgent <input type="checkbox"/> routine <input type="checkbox"/> no threat <input type="checkbox"/>			
B	Priority reported by	1	Rank or position		
		2	Contact name		
		3	Unit identifier/Call sign		
		4	Contact method		
C	POC for further information	1	Rank or position		
		2	Contact name		
		3	Unit identifier/Call sign		
		4	Contact Method		
		5	Rendezvous location for EOR/EOD team		
D	DTG of EO/IED discovery	EO/IED was discovered			
E	Location / area of EO/IED	1	Grid Reference		
		2	Additional location info		
		3	Underwater	Yes <input type="checkbox"/>	No <input type="checkbox"/>
		4	Buried	Yes <input type="checkbox"/>	No <input type="checkbox"/>
F	EOD Identification estimate	What? How many? (use ID Guide codes)			
G	Safety measures undertaken	1	Evacuation distance in meters		
		2	Other protective measures taken		
H	Effect on operation	Totally disrupted <input type="checkbox"/> major <input type="checkbox"/> minor <input type="checkbox"/> nil <input type="checkbox"/>			
I	Other significant info				
J	Date and signature				

NEVER



- TOUCH, MOVE OR DISTURB THE EO/IED
- USE A MOBILE PHONE OR RADIO WITHIN 50 M OF THE EO/IED
- ALLOW **ANYONE** TO RE-ENTER THE CORDON
- GIVE INFORMATION TO CIVILIANS OR TO THE MEDIA



Incident reporting basic information

INCIDENT REPORTING		
UNIT FORMATION:	DATE & TIME:	
SUMMARY OF INCIDENT:		
ACTIVITY:	ITEMS SEEN/RECOVERED:	
REQUESTS:	REQUESTING CONTACT DETAILS/CALL SIGN:	
SAFE ROUTE:		
ADDITIONAL INFORMATION:		
NAME:	SIGN:	DATE:



Special teams that will assist in an incident

DETECTION DOGS

Their role is to assist suspected items clear or confirm if its IED

EOD/IEDD

Their role is mitigation of IED hazards and rendering safe of the same.

Advice ICP commander and his team on safety

WTI

Their role will be forensic material collection and submission.

Scene exploitation on non-physical evidence (swabbing)



Special Teams

First Responders

Civilian fire, medical, and police are used to assist during many peacetime IED incidents. These units are there to assist the incident commander and a relationship should be built immediately.

Search (All Arms Search Team)

Additional Search teams and CIED assists may be required, if the suspect item is found by a non-search trained individual, it may be necessary to search for other devices, and clear the ICP and potential area for secondary devices.



ANY QUESTIONS?



Summary

All personnel should be able to safely conduct the application of the 5Cs in responding to explosive hazard emergencies, this is a key drill that will not only save your life, but it will also directly mitigate against threats and the enemy's ability to hit your C/S, you should conduct your drills correctly, so you do not become a soft target.



Look forward to...

**MODULE 2.1 –
Introduction to Search**



All Arms Search Course (AASC)

Module 2.1 Introduction to Search



Range

- Time 4x45
- Safety
- Questions
- Notes
- Phones/Devices
- Food/Drink
- Previous knowledge
- Assessment



Module Objective

At the end of this module, participants will be able to differentiate the levels of search and explain the capabilities and limitations of intermediate search.



Teaching Points Covered

- Definition of Search (What are we looking for)
- Objectives of Search
 - Offensive
 - Defensive
- Levels of Search (Basic, Intermediate, Advanced)
- Different Types of search
- Principles of search (Systematic, Flexible, Focused and Safe)



Teaching Points Covered Cont'd

- Search Team Structure and their roles
- Search documentation
 - Functions of search documentations
 - Types of documentation
 - Examples of search documentation
- List the types of search equipment
 - In-service handheld metal detector e.g Ebinger, hoodlum
 - Hook/Wire detector
 - Under vehicle mirrors



Definition of Search

The capability to locate specific targets
using intelligence assessment,
systematic procedures and
appropriate detection techniques



What are we searching for?

Terrorist resources

- In manufacture
- In storage
- In Transit – Deployed
- The unusual

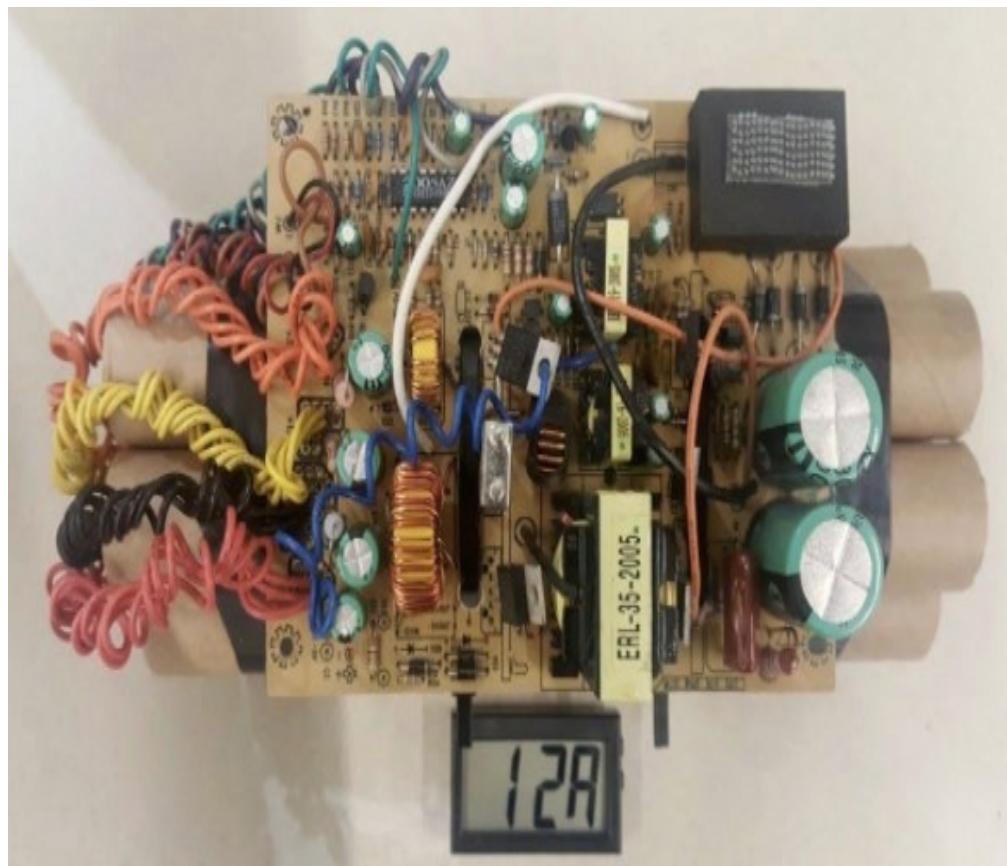



What are we searching for?

- Improvised Explosive Devices (IEDs)
- Component parts for IEDs
- Homemade Explosives (HME)
- Weapons and munitions
- Terrorist/criminal funding/large amounts of money
- Terrorist/criminal propaganda: leaflets, pamphlets



What are we searching for?

- Intelligence
- Plans
- Documentation
- Photos
- Digital information that holds terrorist/Criminal information (DOMEX – Document and Media Exploitation)
- Suspects involved in terrorist/Criminal activity
- Unusually large concentrations of items



Search Objectives

Search Objectives.

Search is a key enabler, providing the means to shape and control the environment in which military assets are active or where there are security interests across the operational framework. Search can be broken down into two distinct elements, offensive and defensive:



Search Objectives

Offensive

- Acquire Intelligence
- Deny Resources and Opportunity
- Gain Evidence for Prosecution
- Why?



Defensive

The objective is to protect potential targets

It has 3 main applications

- Force Protection
- Protection of pre-planned events
- Protection of critical infrastructure



Levels of Search

- Basic search
- Intermediate search
- Advance search



Types of Search

- Person Search
- Vehicle Search
- Aircraft Search
- Vessel Search
- Complex Search Environments (Urban) Defensive Building Search (Venue)
- Hazardous Environment Search
- Covert Search
- Offensive Building Search (Strike Ops)



All Arms Search Course

- Route Search
- Route Check
- Support to IEDD
- Area Search



Principles of Search

- Systematic
- Flexible
- Focused
- Safe



Construct of a Search Team

- Search Advisor (Planner): Sgt – Capt
 - Provides tactical advice to Incident Commander
 - Plan Search Operations
 - Control Search Operations
 - Plan and conduct continuation training
 - Administer Search Teams.
- Search Team (Doer's): Cpl – Sapper/Pte



Search Document Report (SDR) template

SEARCH REPORT MILITARY

Operation:	Serial:
------------	---------

Section A – Pre Task Information

A.1 – Target Details

Type:	Route:	Area:	Building:	Other:
Description:				
Address			GR (Centre or Start)	
			GR (Finish)	
	Nearest Town:		Length or Route	

A.2 – Authority to Search

Authorising Officer	Name:	Rank:	Appt:	Sign:	Date:
Details of authority to conduct search:					



Search Document Report (SDR) template

A.3 – Task Details

Tasked Unit:		HQ Unit:		
		Task AOR:		
Incident Comd:	Name:	Rank:	Unit:	Contact:
Search Adv:	Name:	Rank:	Unit:	Contact:
Police:	Name:	Rank:	Unit:	Contact:
IEDD Op:	Name:	Rank:	Unit:	Contact:
ECM Adv:	Name:	Rank:	Unit:	Contact:
Search Teams:	Team Comd:	Rank:	Unit:	Contact:
	Team Comd:	Rank:	Unit:	Contact:



Search Document Report (SDR) template

SEARCH REPOT MILITARY

Section B – Search Record

B.1 – Access Log

	Number	Rank	Name	Unit	Sign	Search Time
Team A Adv						
Comd						
Scribe						
Searcher						
Searcher						
Searcher						
Searcher						
	Number	Rank	Name	Unit	Sign	Search Time
Team B Adv						
Comd						
Scribe						
Searcher						
Searcher						
Searcher						
Searcher						
	Number	Rank	Name	Unit	Sign	Search Time
Female Searcher						
Dog Handler						
Dog Handler						



Search Document Report (SDR)template

B.2 – Entry Procedure

Explain Process of entry including details of damage caused:

B.3 – Persons Present

Ser	Surname	Forename	Sex (M/F)	DOB	ID Details	Status in Property	Time Searched	Comments
1								
2								

B.4 – Vehicles Present

Ser	Make	Model	Colour	VRN	Owner	Engine No	Comments
1							
2							

B.5 – Authorised Weapons

Ser	Type of Weapon	Serial Number	Certificate Number	Ammo Held	Owner	Comments
1						
2						



Search Document Report (SDR)template

B.6 – Search Log

Ser	Date / Time	Event	Action Taken
1			
2			

Number:	Rank:	Name:	Unit:	Sign:
The above mentioned person, handed this report to the below mentioned person.				
Number:	Rank:	Name:	Unit:	Sign:



Highly used Search equipment

- F3 Metal Detector
- Ebinger magnetometer detector
- Hoodlum metal detector
- Hook/wire detector
- Under vehicles search mirrors



F3 Metal Detector





Learning Objective

The Participants will learn the proper use of the Metal Detector



Introduction

- The F3 is a robust detector that is extremely simple to operate. There are no complicated controls resulting in the operator being able to focus on the vital task of mine detection.
- Understanding the correct operation and use of the detector will aid you in your clearance procedures



Scope

- Description
- Preparation
- Operation
- Maintenance



ANY QUESTIONS?



Description

- The F3 mine detector incorporates Bi-polar technology that enhances Minelab's Multi-Period-Sensing (MPS) technology. Through MPS, the sensitivity of a detector remains consistent regardless of the mineralized content of soil. Additionally, Bi-polar technology assists in eliminating the possibility of initiating a magnetic influence mine.



Description

- Shipping weight: 12.6kg
- Operating weight: 2.3kg
- Operating Length:
- Fully extended length: 1500mm
- Short Mode: 760mm
- Batteries 4 x 1.5V D Cell Alkaline, or; Rechargeable NiCad or NiMH D



Description



Fig 1: Stowed in Transit Case



Fig 2a



Fig 2b

Fig 2: Configured for use:

2a: Short mode (Used in Kneeling or Prone position)

2b: Fully Extended (Used in standing position)



Description

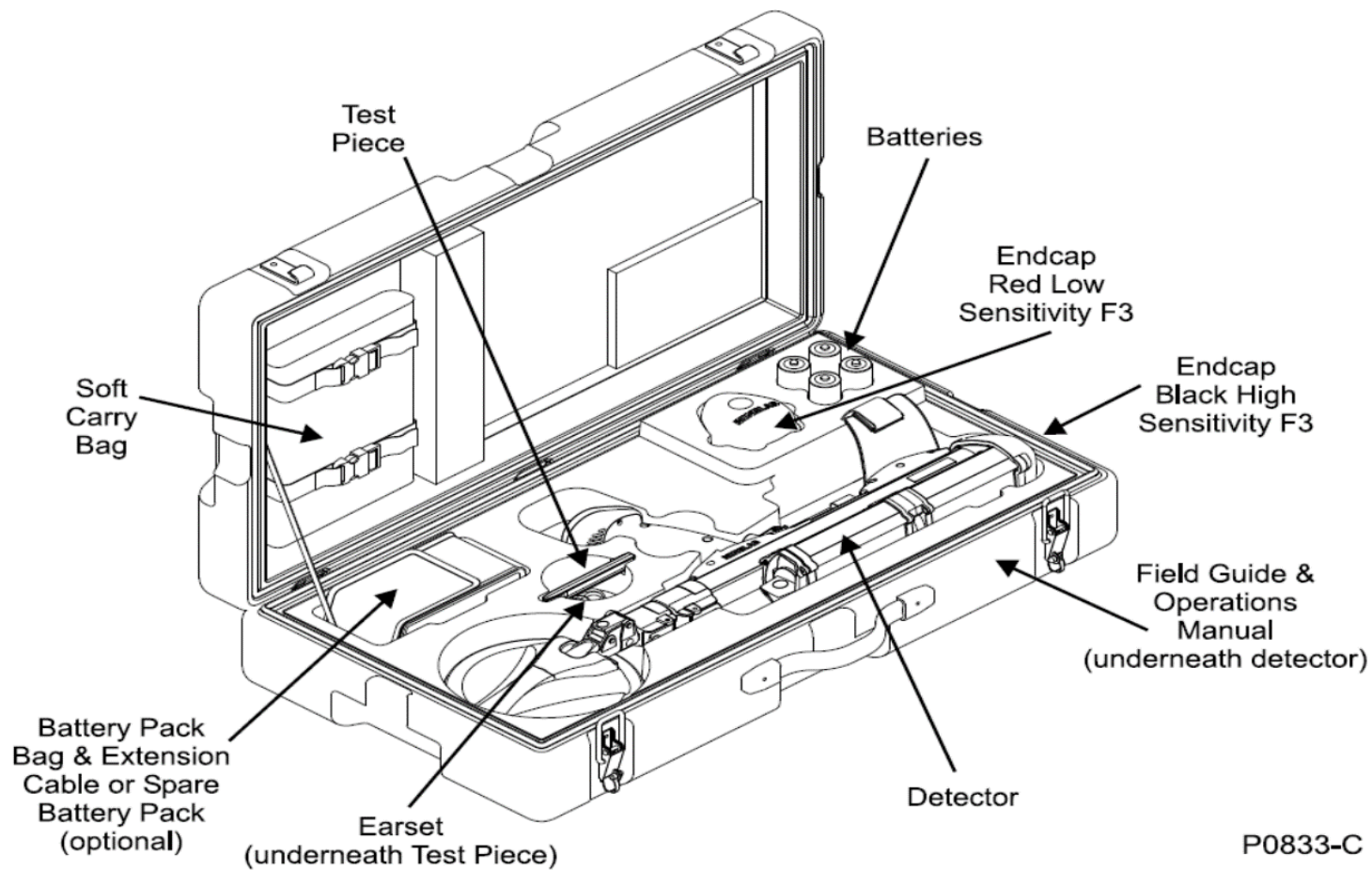



Description

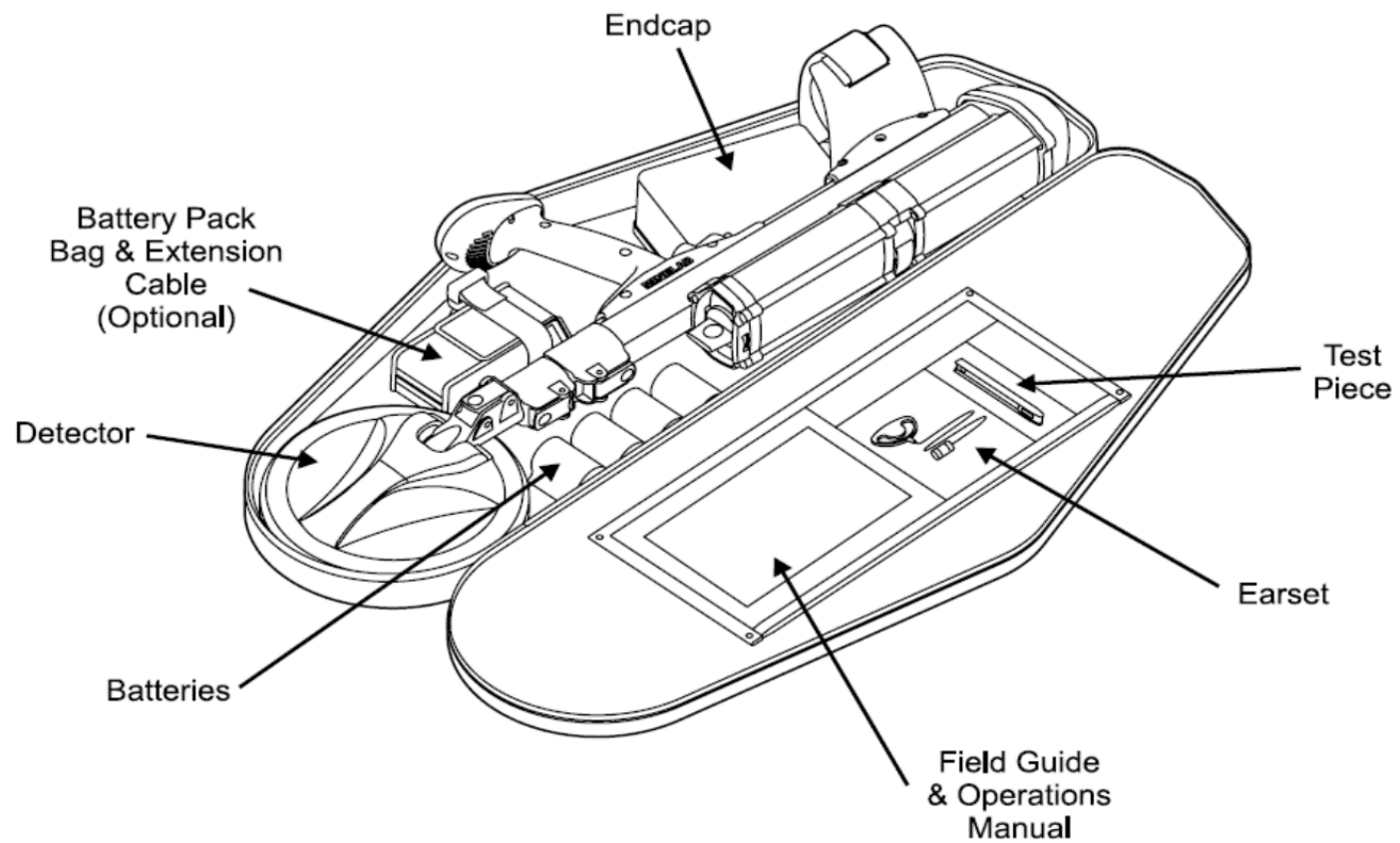



Description

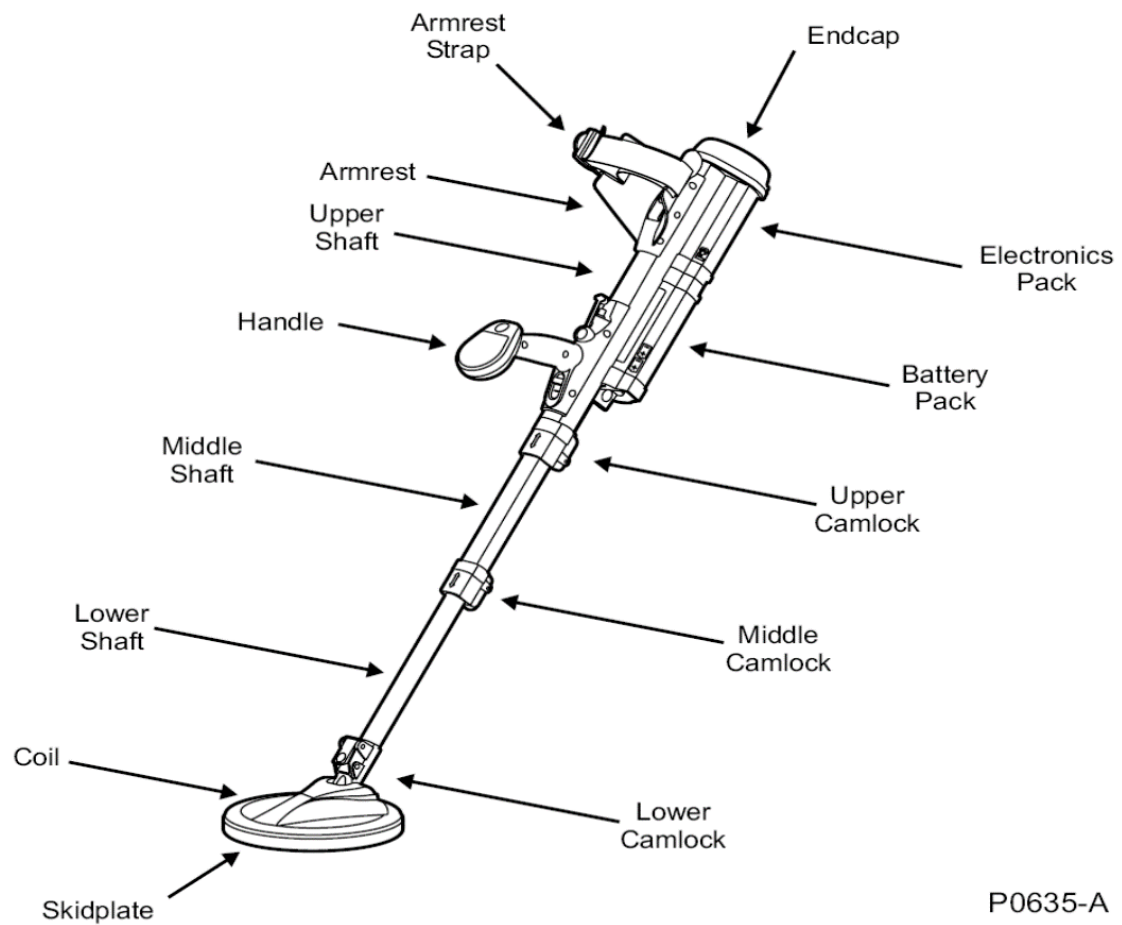

P0635-A



Description

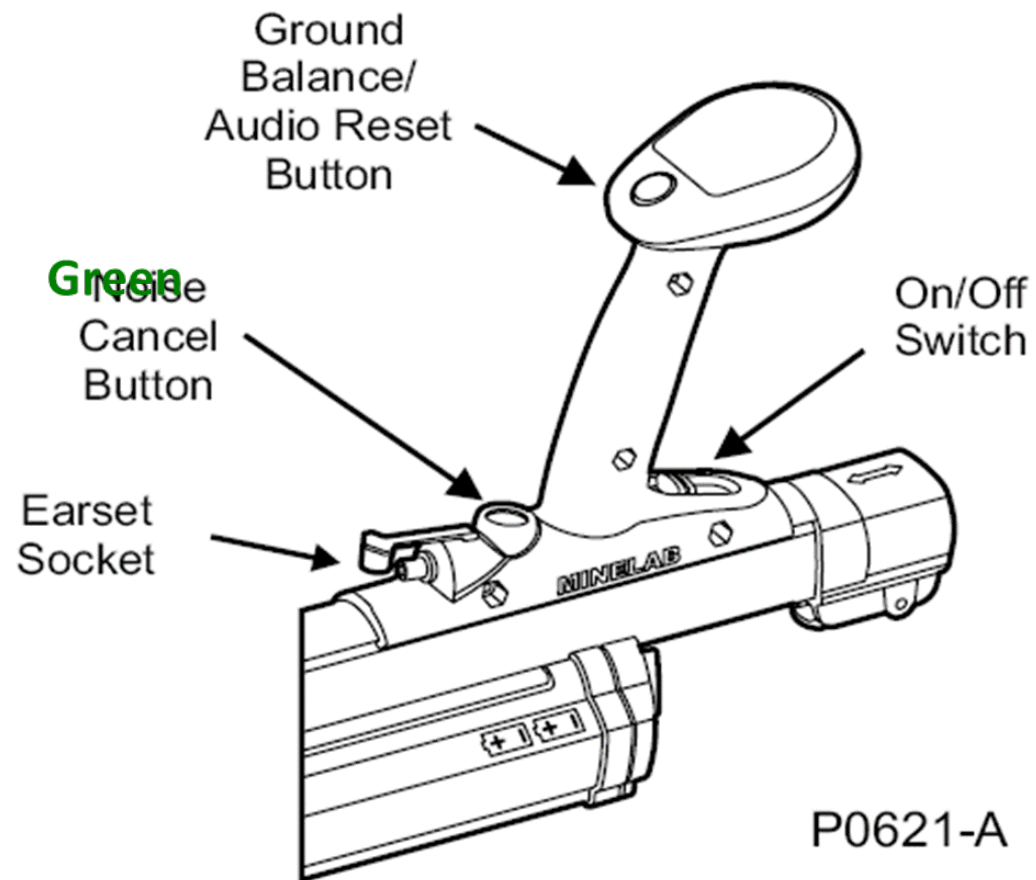



ANY QUESTIONS?



F3 Preparation

- Inspect for obvious signs of damage.
- Ensure correct Sensitivity End-cap is fitted.
- Hold in an inverted position with the End-Cap resting inside of the carry case.
- Unlock Battery Pack Lid by twisting Lock Lever counter-clockwise one-quarter.
- Once unlocked, pull the lid away from the Battery Pack.



F3 Preparation

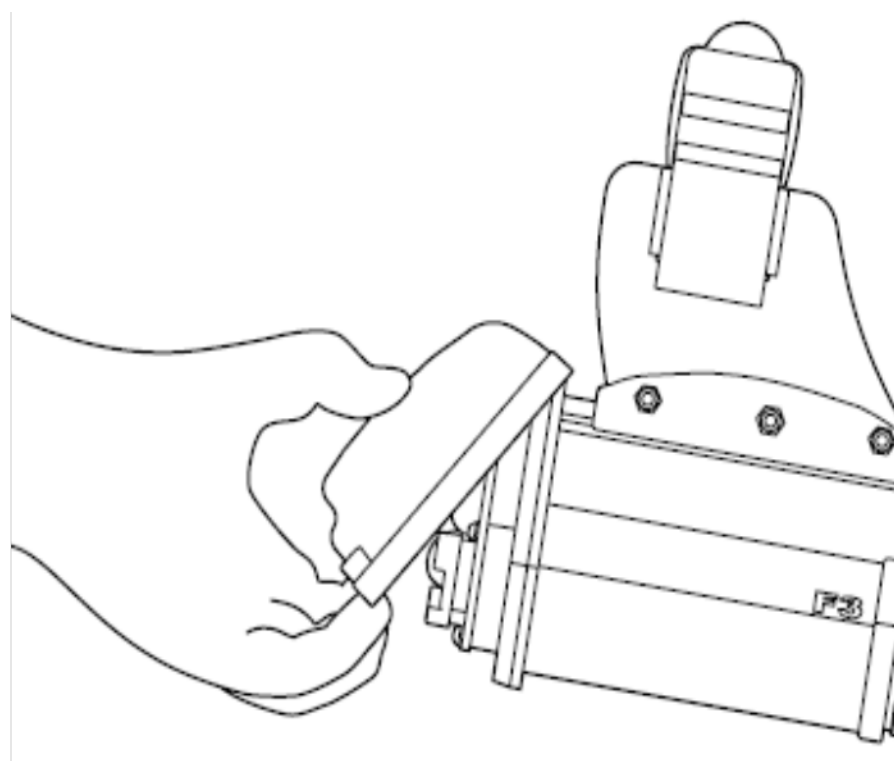
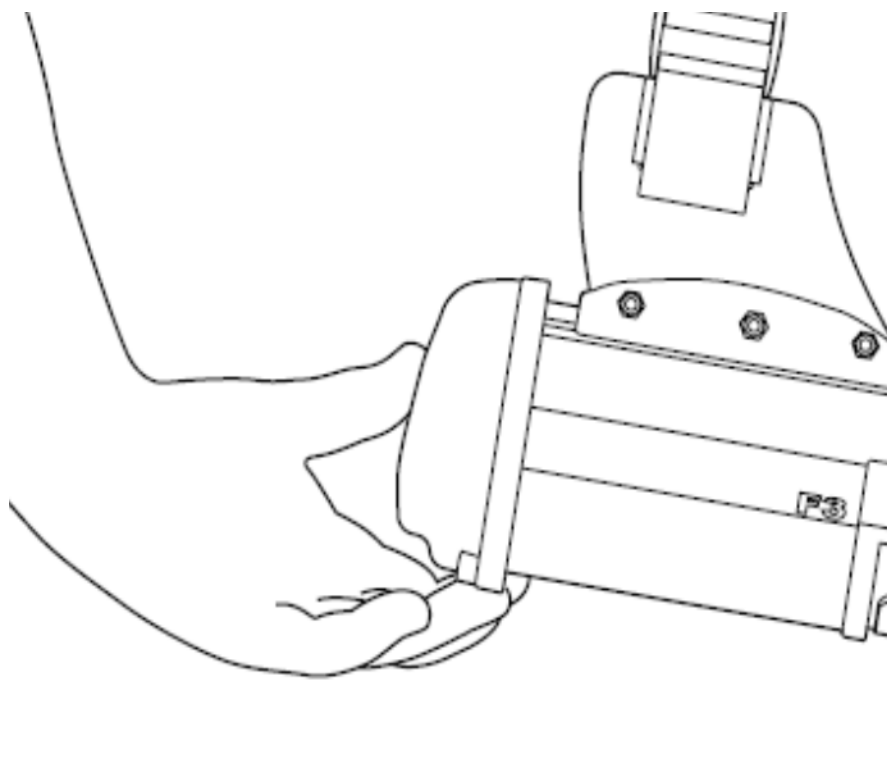

The F3 can be used with Black
or
Red Sensitivity End caps.



F3 Preparation

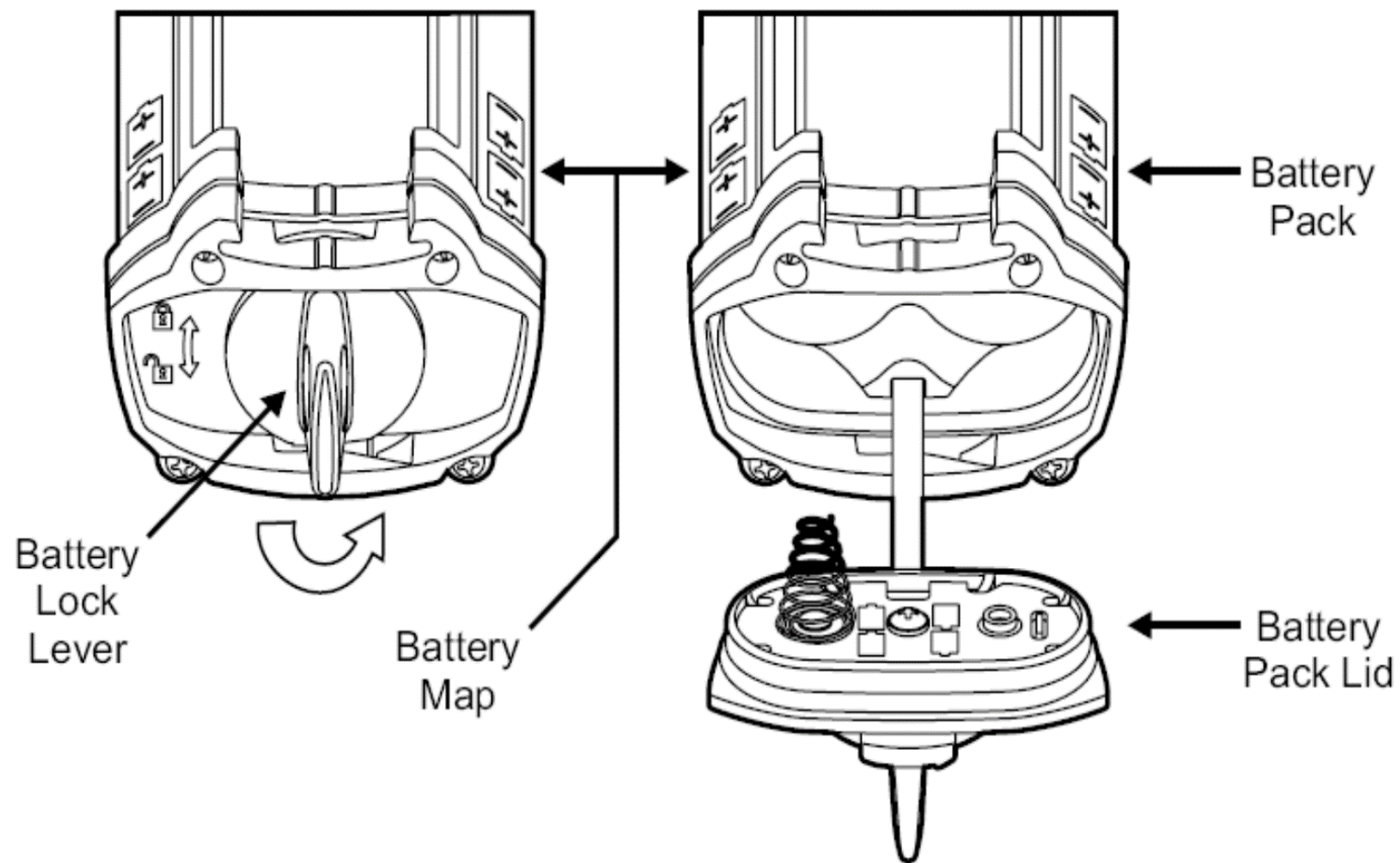



F3 Preparation

- Open Lower Cam-lock, rotate coil to the desired position.
- Normal coil position is in line with the shaft.
- Once position selected, lock coil with the Lower Cam-lock.
- Point coil toward the ground, open Middle Cam-lock, extend Lower Shaft as required then Lock Middle Cam-lock

Note: Lower shaft must extend a Min 100mm.



F3 Preparation

- Open Upper Cam-lock, extend Middle Shaft to required length. Lock Middle Shaft in position using Upper Cam-lock.
- Undo dust caps from the Ear piece set plug and Ear set socket on the detector.
- Hold Ear piece set by the rubber collar with thumb and index finger (raised double arrow should be uppermost).
- Align plug with the Ear set socket and firmly slide the collar onto the socket.
- Confirm plug is locked by gently pulling back on the rubber collar.



F3 Preparation

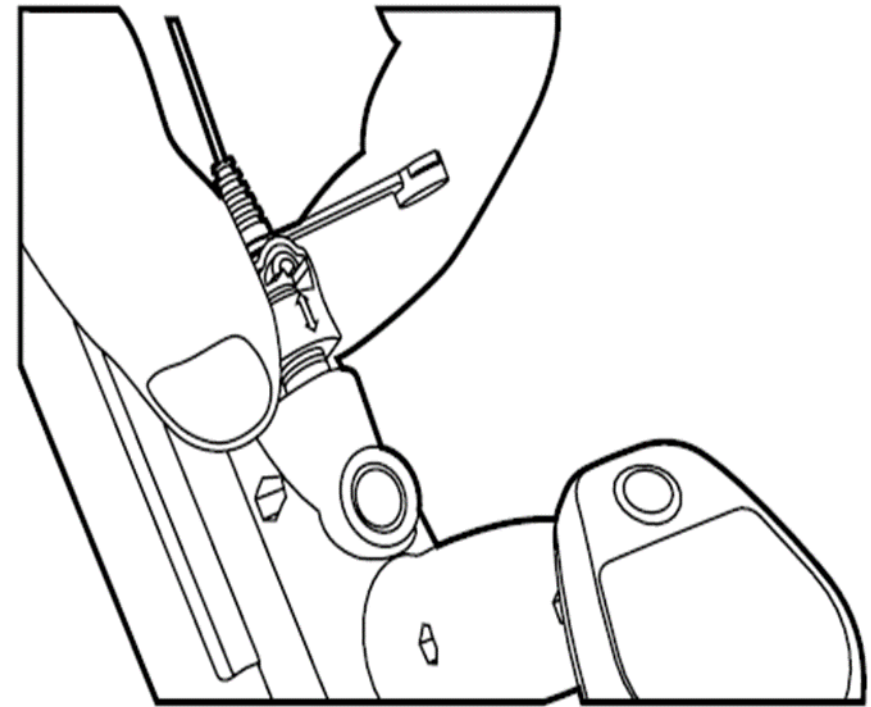
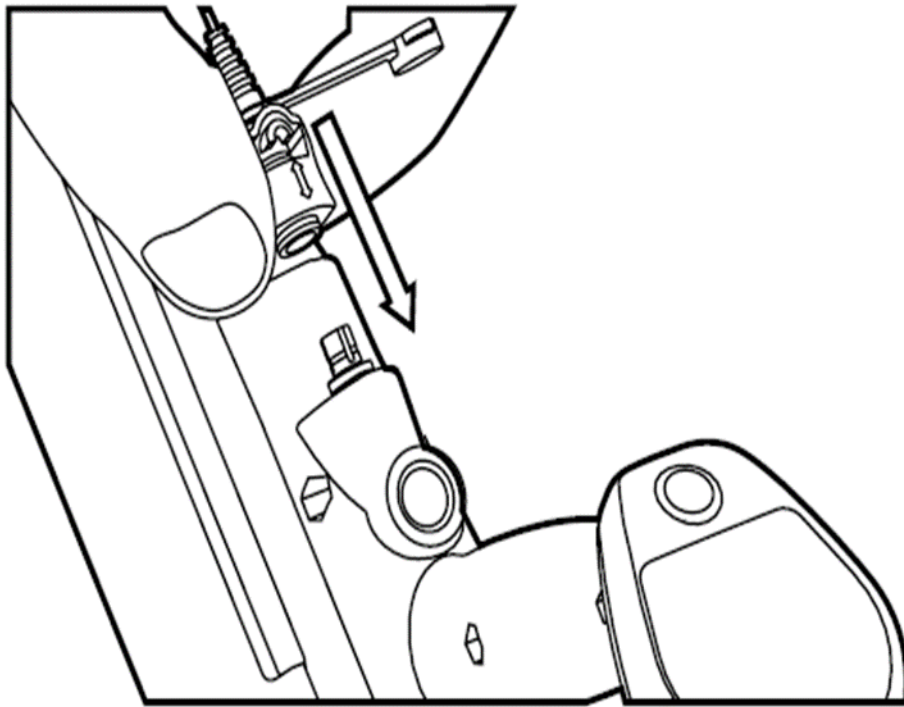



F3 Preparation

- Open the Armrest Cam-lock and slide Armrest to the desired position and Lock the Armrest Cam-lock adjust Arm-strap as required.
- The F3 is now ready for use.

NOTE:

Batteries can be inserted and removed from the Battery Pack while attached to the Upper Shaft Alternatively, the Battery Pack can be removed from the Upper Shaft by pulling down the Lock Lever located between the Battery Pack and the Electronics Pack.



F3 Preparation

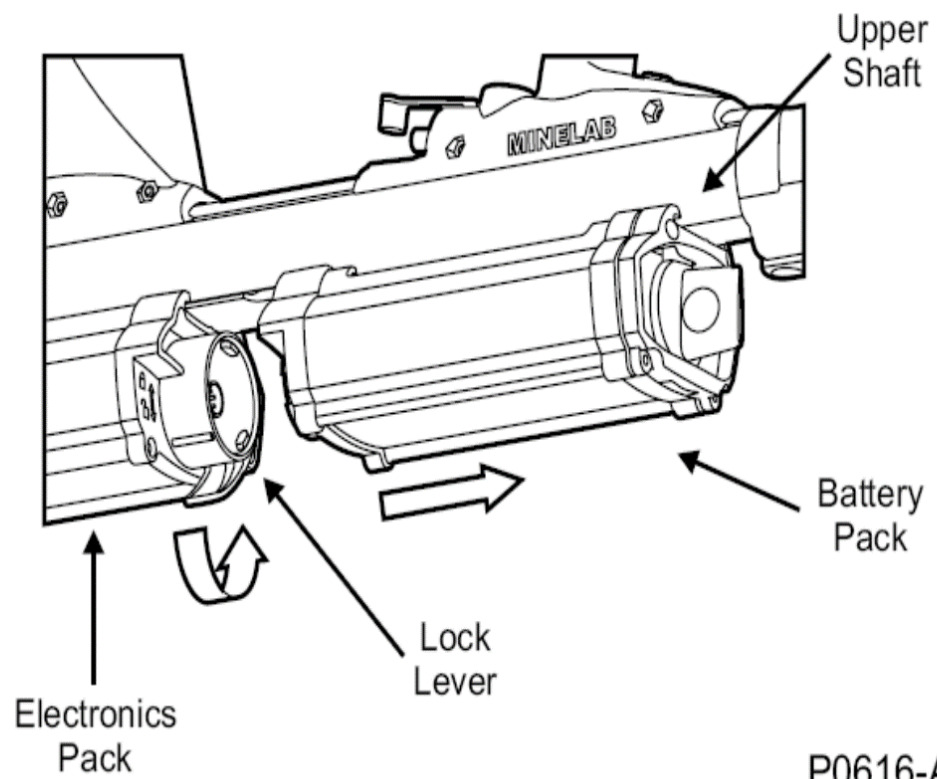

P0616-A



ANY QUESTIONS?



F3 Startup and Operational Controls

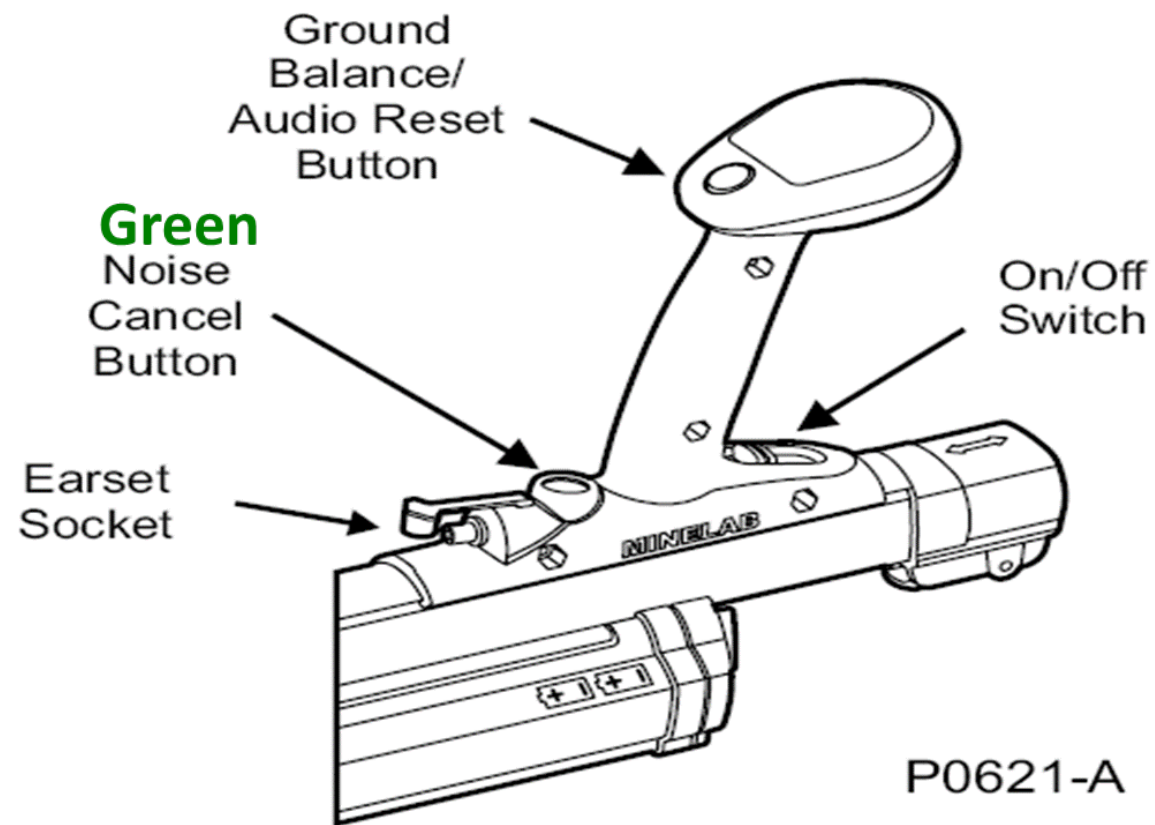



F3 Startup and Operational Controls

- Ground Balance/Audio Reset Button. Green Button on top of the Handle, this dual action button does the following:
 - _ Ground Balance. F3 able to detect metallic mines in all ground conditions. False alarms due to mineralized soils are automatically removed using the Ground Balance function.



F3 Startup and Operational Controls

- Audio Reset. Occasionally, the Threshold Tone may be louder than normal and can be returned to the normal volume using the Audio Reset function
- Noise Cancel Button. Black Button is located to the rear of the Handle. Electrical Interference occasionally causes Threshold Tone to vary in pitch and volume degrading the operator's ability to distinguish targets. Noise Cancel automatically selects a frequency minimizing interference



F3 Functional Tones

Tones	Event	Description
Start-Up	Internal checks when the F3 is switched on	Four rising tones over 12 seconds
Threshold	Signifies correct operation of detector	Steady low volume continuous tone
Ground Balance	Indicates successful Ground Balance procedure completed	One fast high pitched double beep
Target	Indicates metal target detected	Increases volume (compared to Threshold Tone) and high or low pitch depending on target metal composition and depth
Low Battery	Indicates batteries do not have enough charge to continue detection	High pitched fast continuous oscillating tone
Equipment Fault	Indicates failure of detector component or a dislodged Red Sensitivity Endcap	Low pitched slow oscillating tone (ee-aww, ee-aww)
Coil Fault	Indicates coil not connected or not receiving sufficient current	Low pitched double tone every five seconds
Noise Cancel	Indicates Noise Cancel procedure is occurring	Two single beeps followed by 45 seconds of short double beeps finishing with four single beeps



F3 Test Piece

- The F3 is supplied with a Test Piece to confirm that the detector is working to correctly.
- Checked with the Test Piece before, during and after operations, (IAW with SOPs).

NOTE:

Max sensitivity is only available 30 seconds after the Threshold Tone is heard. Do not test the detector with the Test Piece until 30 seconds after the Threshold Tone is heard.



Step One

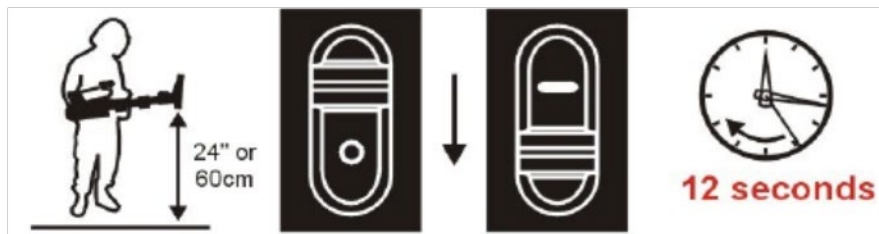
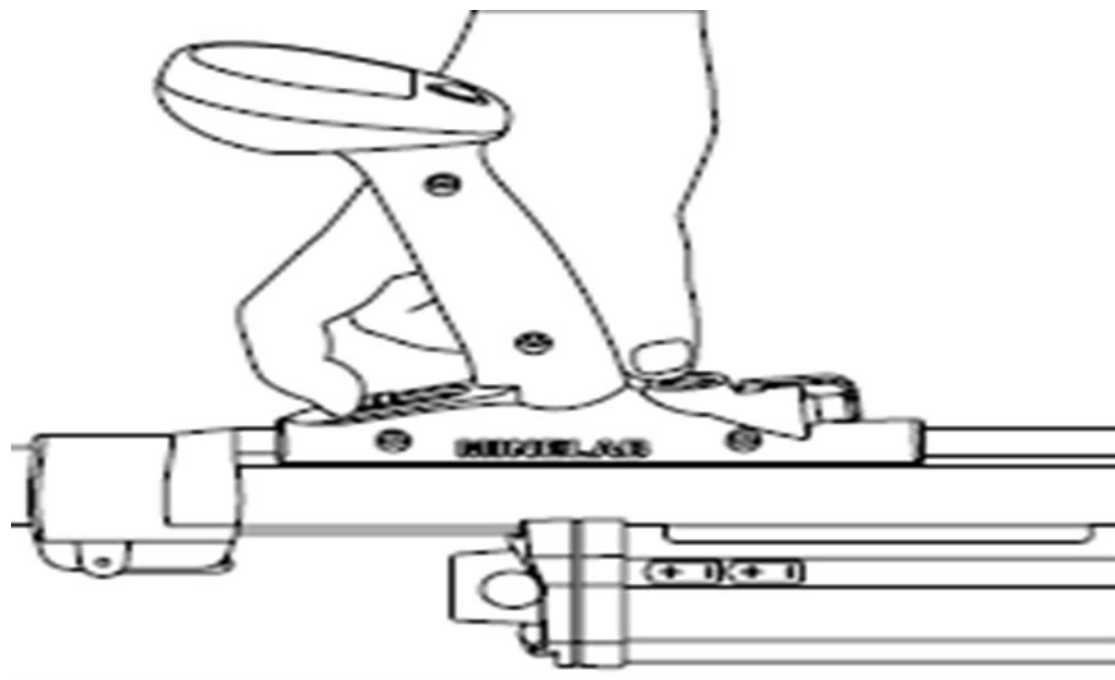



Step Two Ground & Balance

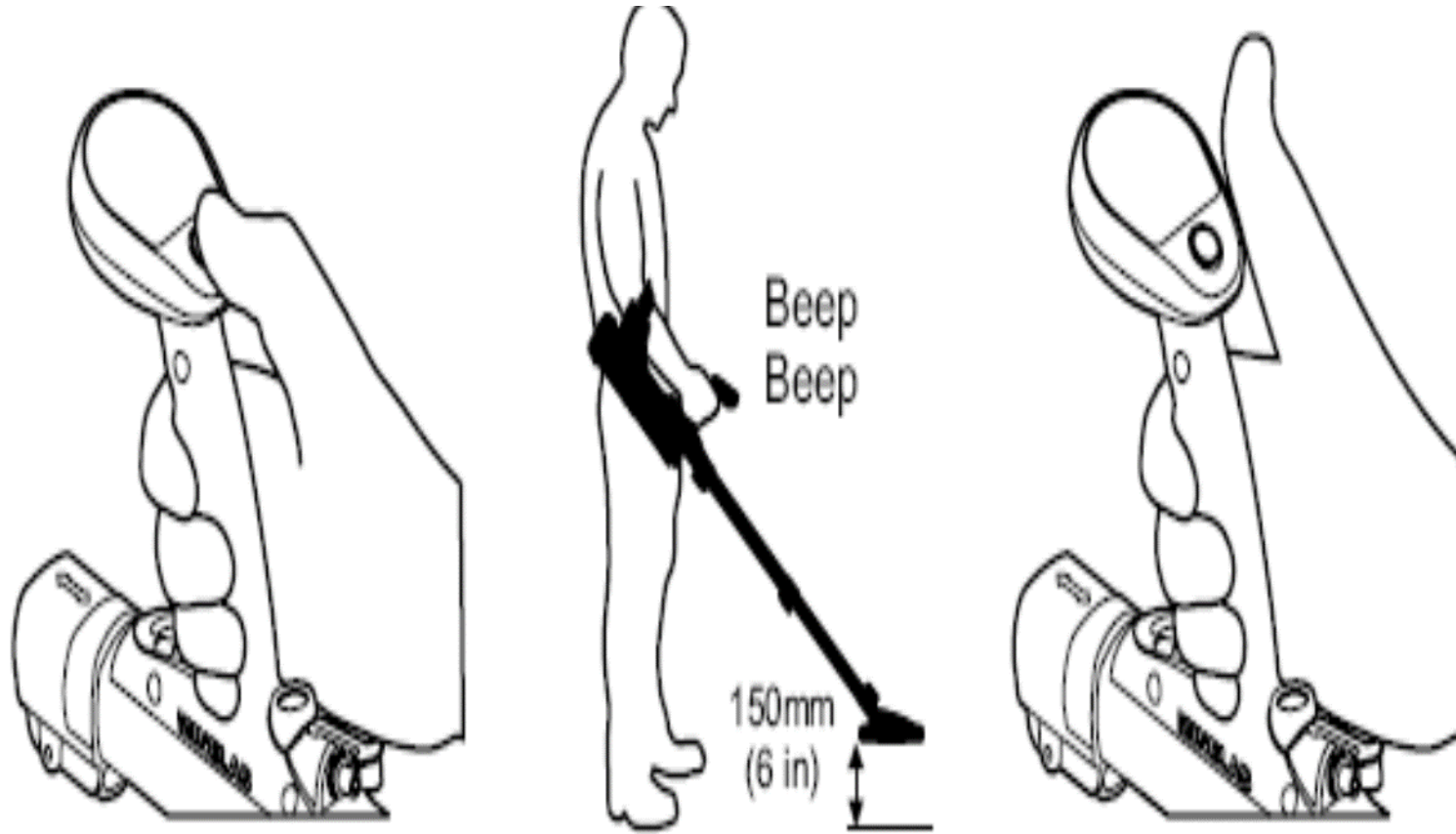



Step Three Test Piece

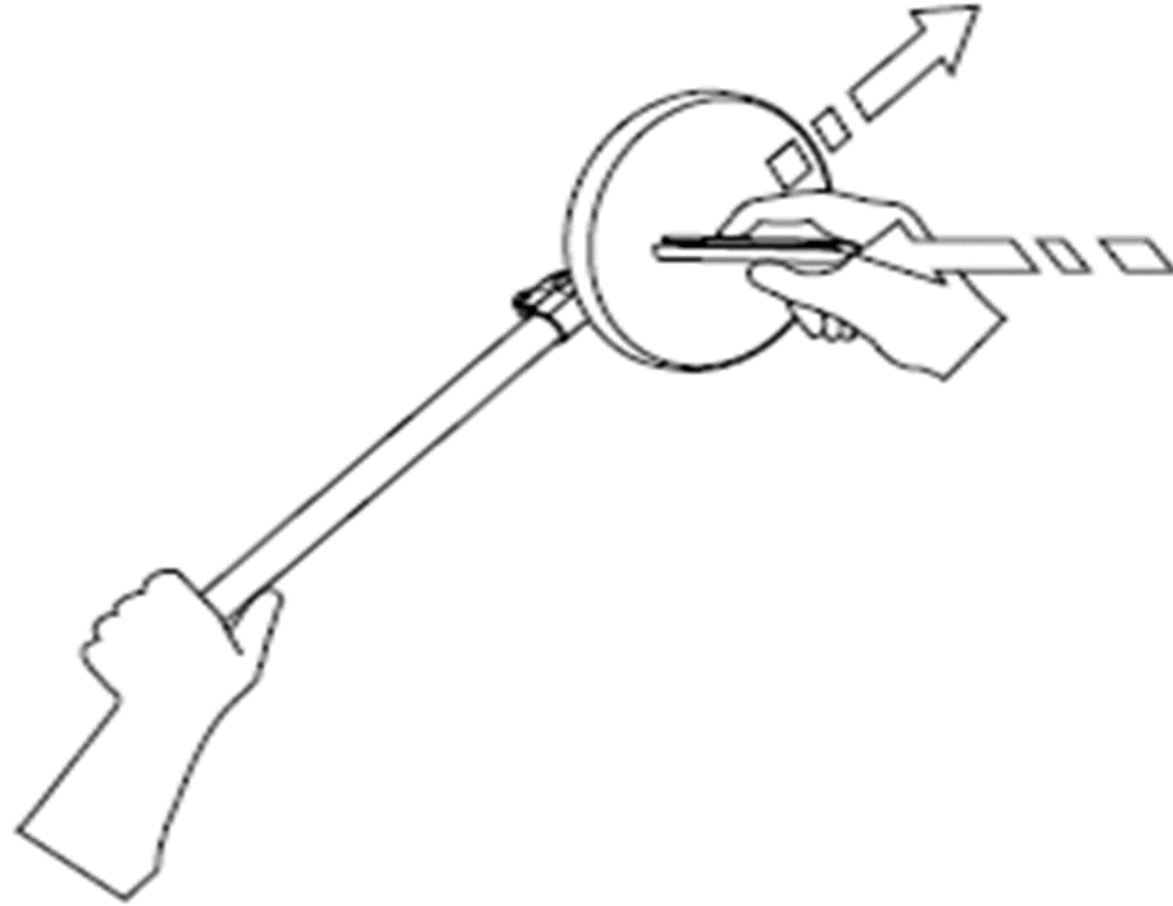



Noise Cancel

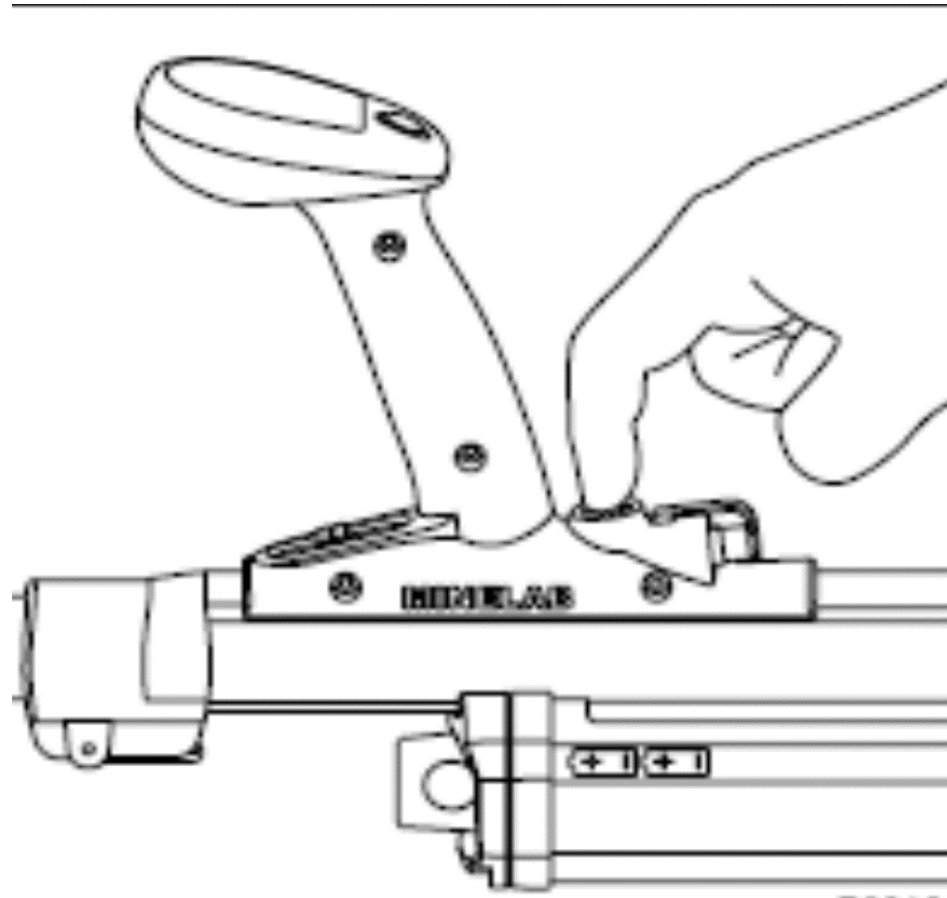



Audio Reset

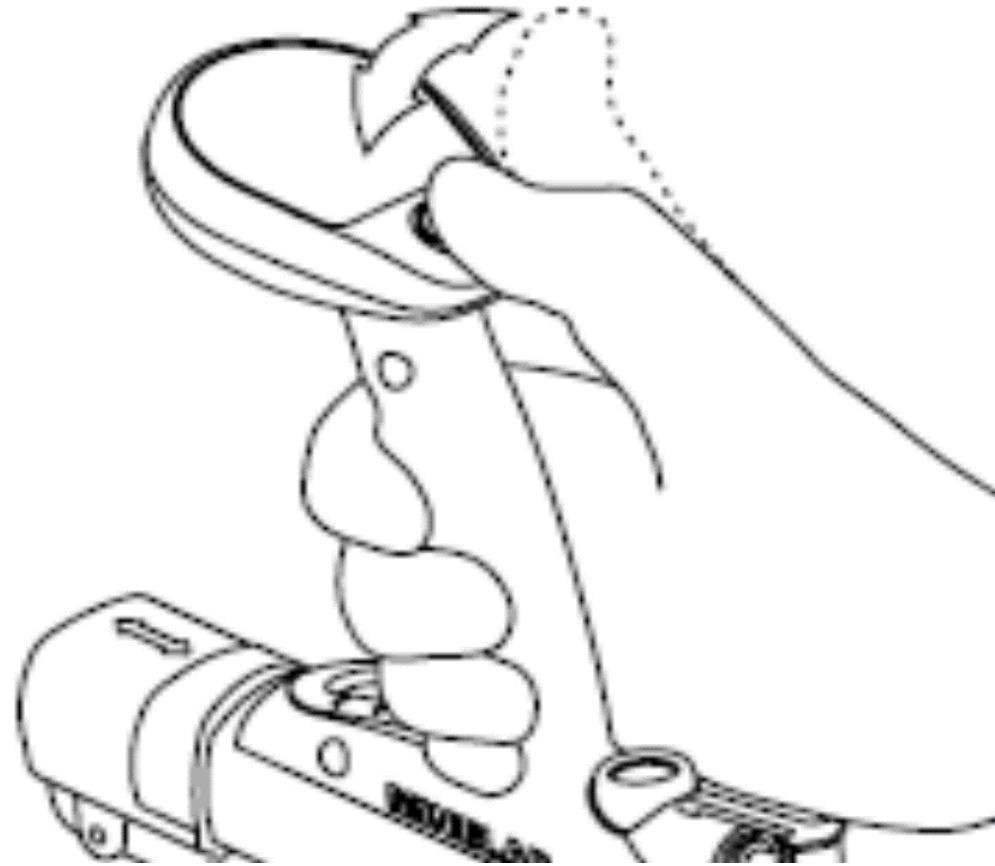



Sweeping Procedures

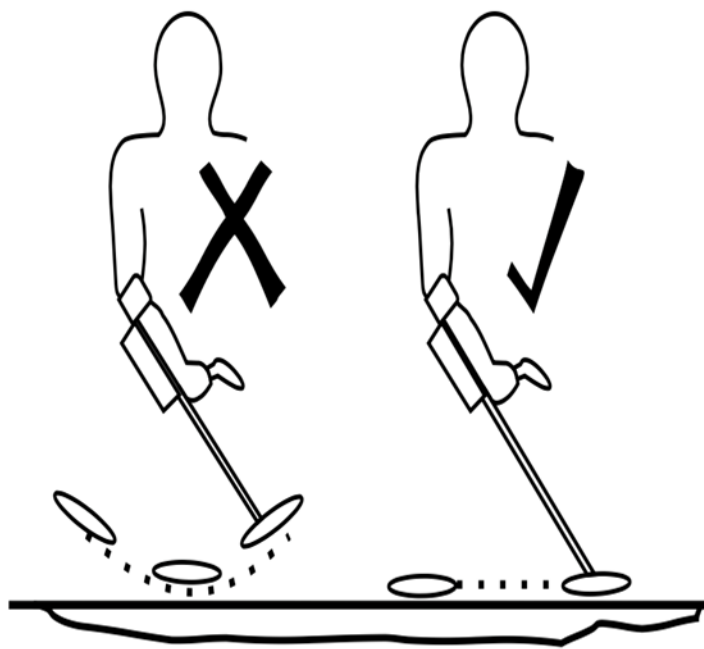

P0624-A

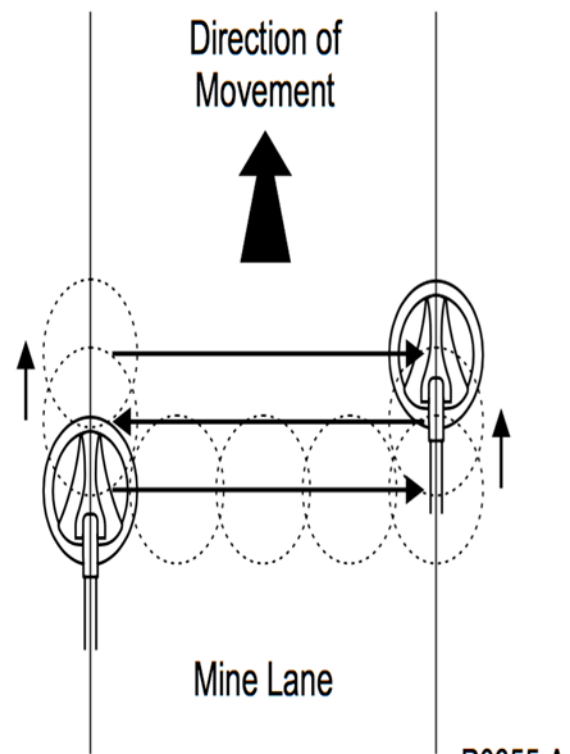

P0655-A



Sweeping Procedures & Pin Pointing

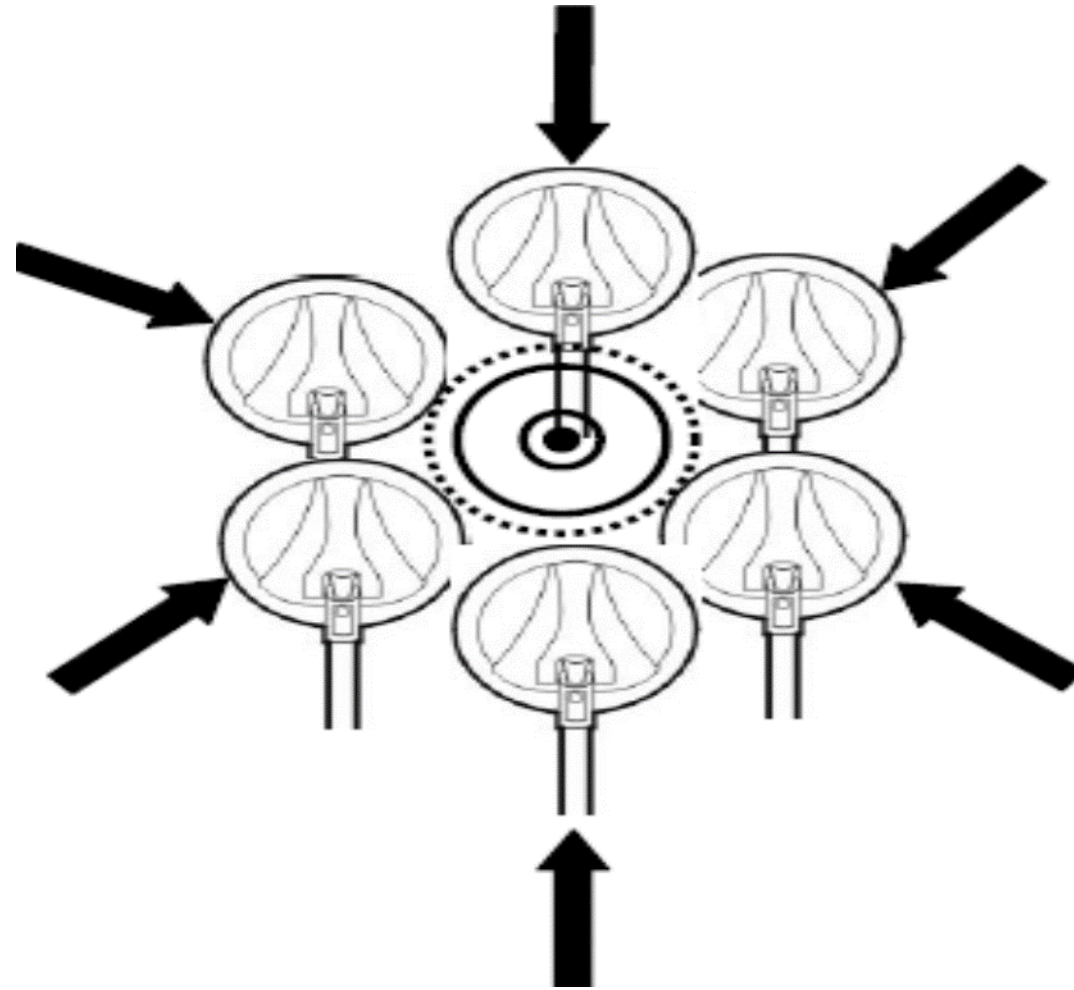



Determine Centre of Target

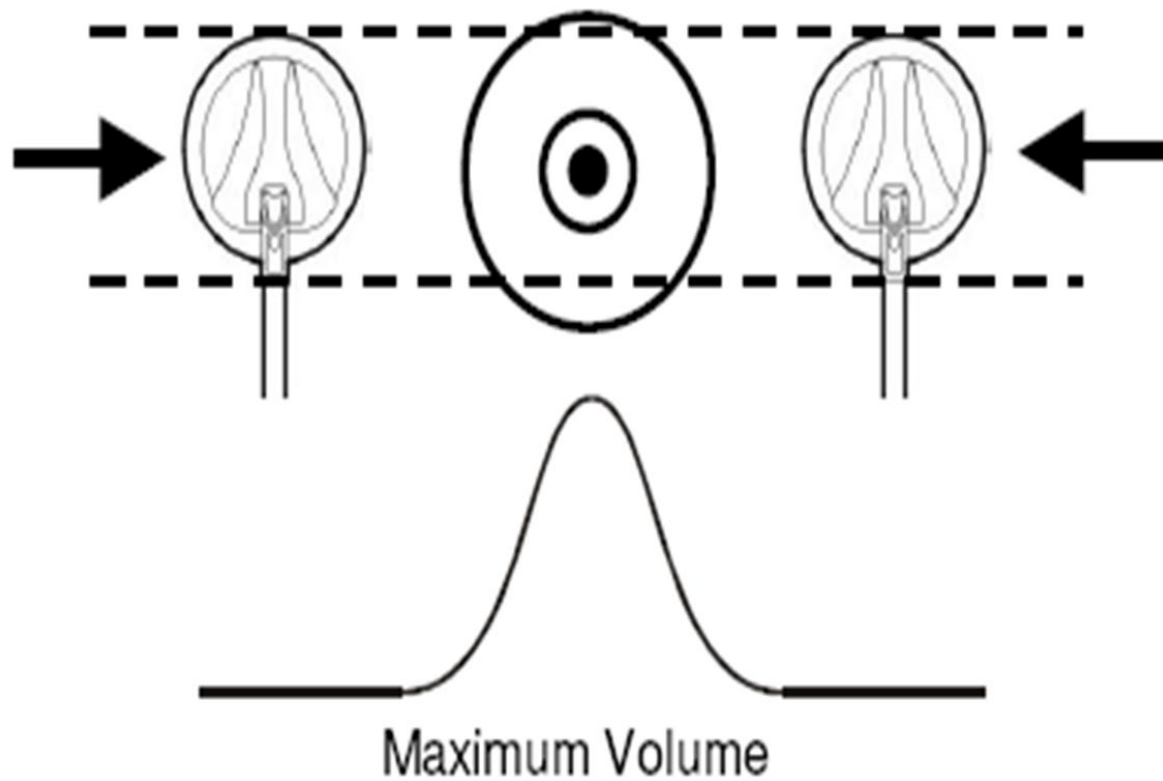



Multiple Targets

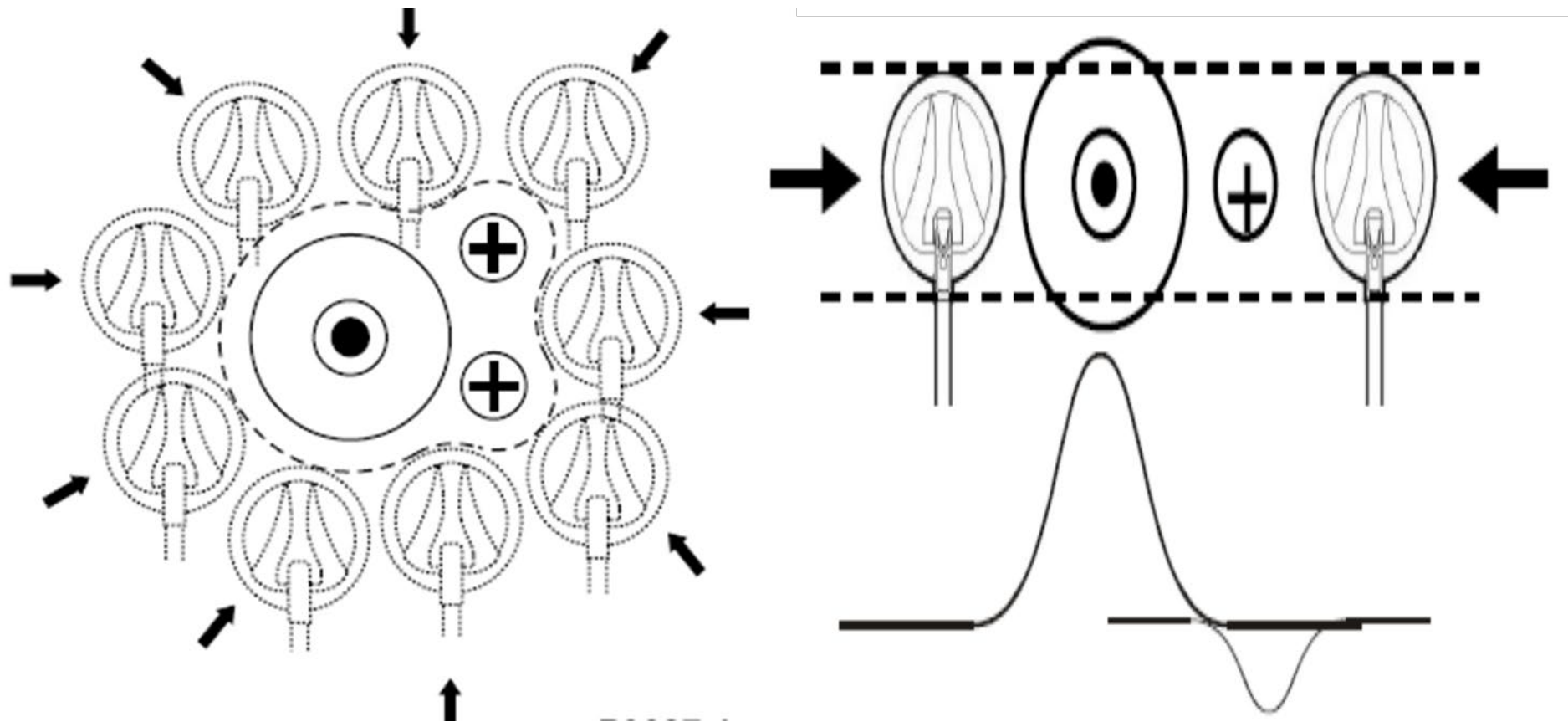



Multiple Targets

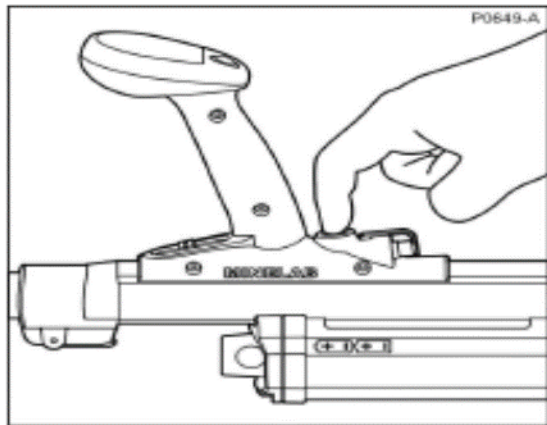

NOISE CANCEL

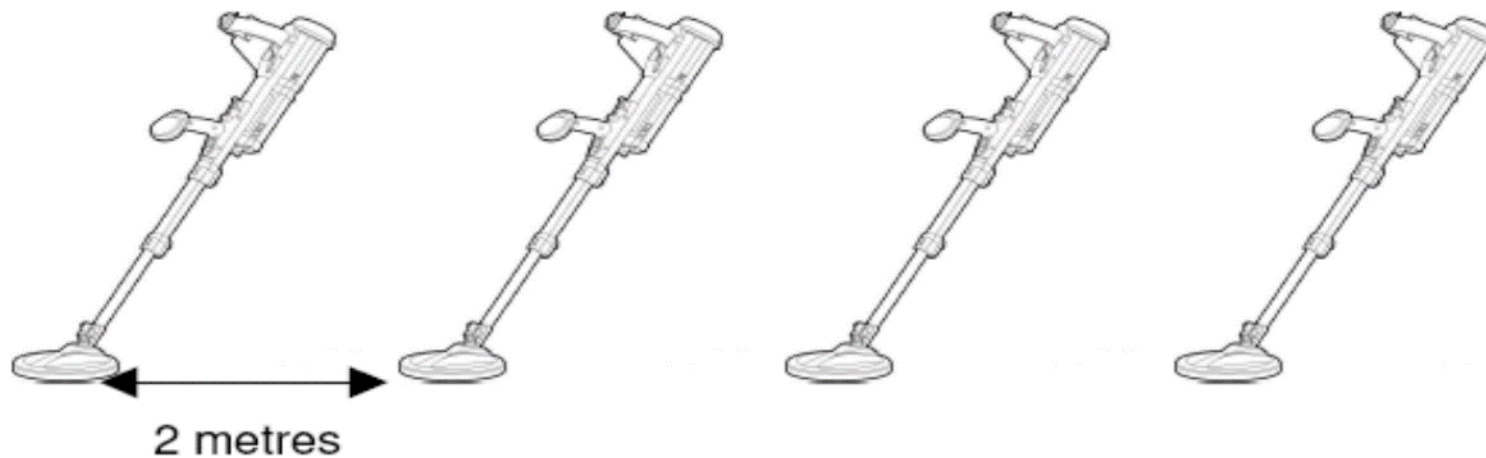



Changing Batteries

- Only when voltage drops to unacceptable level and alarm sounds.
- Stop search, switch off.
- Replace batteries, resume search.
- No need for ground balance, if operating on same ground.



Completion of Operations

- Check with a test piece.
- Switch Off.
- Clean and check for damage.
- Remove batteries.
- Disconnect earpiece.
- Retract shafts.
- Stow in case/bag; ensure components are packed correctly.



Routine Care

During rest periods, if possible, shelter detector from direct sun, rain, snow etc

Before packing and with the F3 fully extended, all shafts should be wiped with a damp clean cloth to remove dirt and dust

Do not use solvents. If the detector comes into contact with solvents (including salt water) clean with fresh water and a dry clean cloth

Ensure F3 dry before packing

Ensure batteries are removed before packing

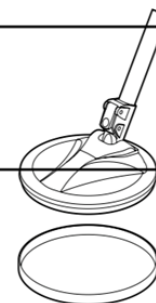

Replace skid plate as necessary to ensure protection of coil surface

P0654-A



Trouble Shooting

Problem	Recommended Procedure
F3 will not switch On	<ol style="list-style-type: none">1. Check batteries have been inserted correctly2. Replace batteries3. Remove Battery Pack and reconnect4. Exchange Battery Packs
After switching On there is a very loud noise	<ol style="list-style-type: none">1. Ensure Lower Shaft is extended at least 100mm (4ins) beyond Middle Shaft2. Conduct Audio Reset
After switching On the Threshold Tone varies in pitch and volume even though the coil is stationary	<ol style="list-style-type: none">1. Conduct Noise Cancel



Trouble Shooting

Problem	Recommended Procedure
There is no sound from the Earset	<ol style="list-style-type: none">1. Disconnect and reconnect the Earset2. Try a serviceable Earset (if problem solved original Earset is faulty)
There is no sound from the Speaker	<ol style="list-style-type: none">1. Switch Off and On2. Disconnect Earset, Switch Off and On
The Start Up Tones keep repeating	<ol style="list-style-type: none">1. Replace batteries
Cannot hear Test Piece with RED Endcap	<ol style="list-style-type: none">1. Repeat Test and ensure metal in Test Piece is pointed toward the coil surface
Cannot hear Test Piece with BLACK Endcap	<ol style="list-style-type: none">1. Ensure that the detector has been switched on for at least 30 seconds.



Magnetometer





Small Handheld metal detector





Hook / Rake





Search mirror





ANY QUESTIONS?



Questions

1. What is the definition of Search?
2. What are we searching for?
3. What information is required on a Search Document Report (SDR)?



Summary

Search is a key component of two of the three pillars of the CIED framework, without the correct application of search you will never be able to get find the device, if you are not able to find the device you will have no hope of attacking the network.



Look forward to...

MODULE 2.2 – BASIC SEARCH



All Arms Search Course (AASC)

Module 2.2 Basic Search



Range

- Time
- Safety
- Questions
- Notes
- Phones/Devices
- Food/Drink
- Previous knowledge
- Assessment



Module Objective

At the end of this module, the participants will be able to apply the correct procedures in conducting person and vehicle searches.



Teaching Points Covered

- Person search
 - a. Categories of person search
 - Initial
 - Detailed
 - Strip
 - Intimate
 - b. Types of equipment
- Vehicle Search
 - Categories of vehicle search
 - Initial
 - Primary
 - Secondary
- Baggage search
- Search Report



Person Search

- Purpose of a person search
 - Deny the enemy the opportunity to move resources on their person
- What are we searching for?
 - Immediate Threats
 - Contraband
 - Exploitable Materials



Person Search

- Inform subject of the reason for the search
- Give them the opportunity to surrender any items voluntarily
- When using an interpreter:
 - “Sir/Ma’am as a member of..... I am going to conduct a person search. If you have any items on your person and you wish to surrender them, you may do so now.”
- Need to check the law for here



Person Search

- Care must be taken to minimize the risk of allegations
 - Brutality
 - Assault
 - Unethical treatment
 - Sexual Harassment



Indicators of Suspicious Behaviour

- Wringing of hands
- Excessive blinking
- Rapid eye movement
- Excessive sweating
- Physical or audible shaking
- Non-Compliance
- Inconsistent answers
- Lack of eye contact
- “Gut instinct”



Categories of Search

This lesson will deal with “Quick” and “Detailed” only. These are the only searches that soldiers may routinely undertake, there are however 4 searches in total.

- Quick - In public eye
- Detailed - Out of public eye
- Strip - In place of confinement – Request approval from higher
- Intimate - By a doctor – Request approval from higher



Quick Search

- Used when dealing with a large number of people
- Ideally used with a handheld metal detector
- Commonly conducted by local police and military



HOODLUM

The individual must be asked if he/she has any personal medical equipment in use (e.g., pacemaker) prior to them being searched

Do not overemphasize body shape or contour the body when searching.





Quick Search

- State reason for search
- Monitor body language of suspect
- Overcoat and hats may be removed
- Check contents of pockets
- Investigate most likely areas of placement
 - Small of back
 - Under arms
 - Crotch area



Quick Search

- Reaction
 - If satisfied with quick search, then no further investigation is needed
 - If suspicion is aroused the next step is the Detailed Search



ANY QUESTIONS?



Detailed Search

- A detailed search may now be undertaken
- The searcher **SHOULD** be of the same gender
 - Mission and situation dependent
- The search is conducted out of the public view
- A female searcher **SHOULD** be available to search children





Conduct of Detailed Search

Have subject empty contents of pockets

- Place in clear container
- Keep in view of subject

Ask if he/she has anything that may cause harm to yourself or me

- Sharp Objects
- Explosives
- Weapons

Begin to systematically search



Search Example

- Special attention paid to
 - Headgear
 - Collar
 - Armpits
 - Cuffs
 - Waistband
 - Groin
 - Trouser cuff
 - Footwear

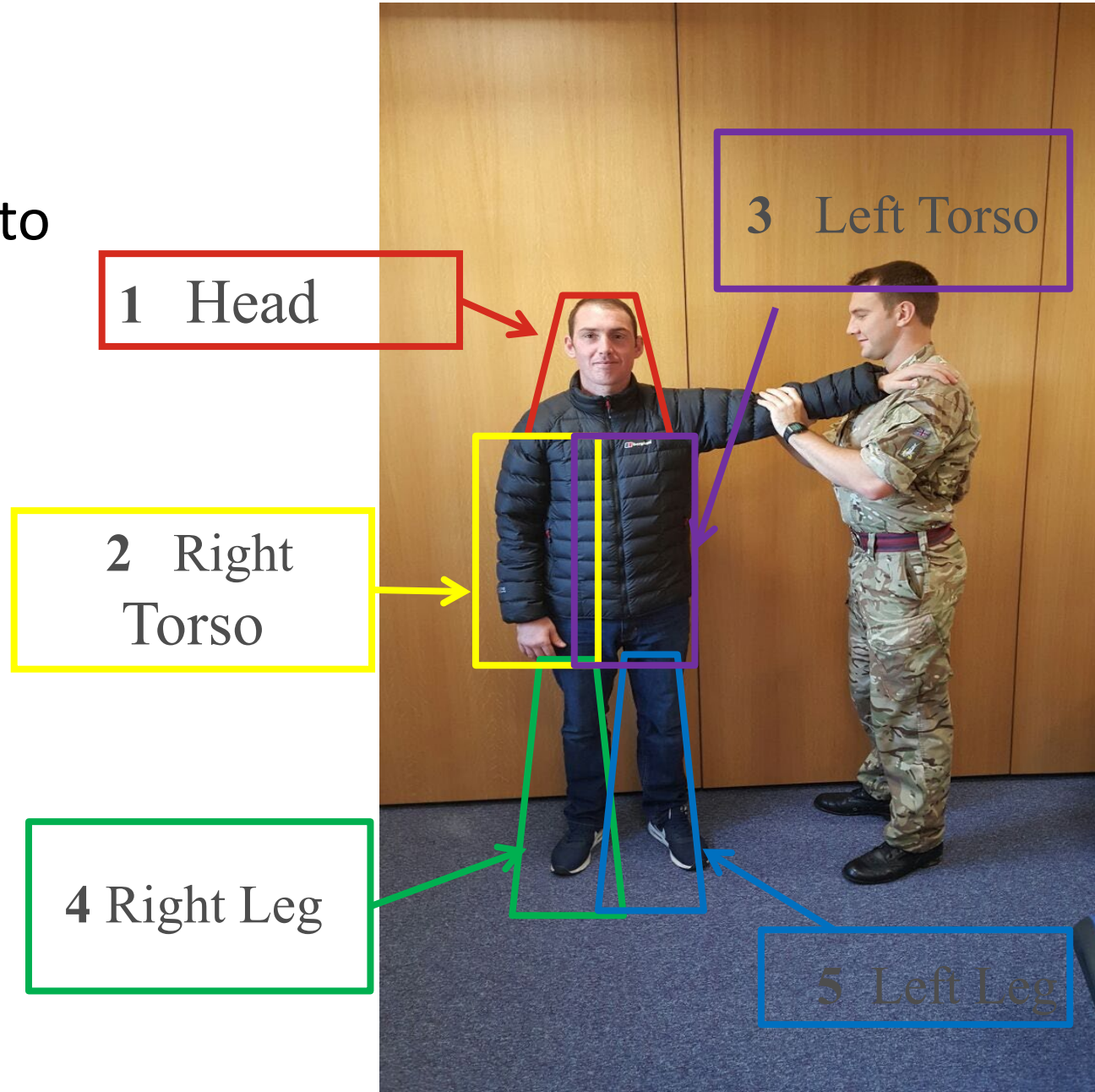



Remember

- Pay special attention to the seams of clothing
- Remove hats and overcoat
 - Based on country and local traditions
- Treat subjects' personal property with respect
- Systematic search of connected baggage



ANY QUESTIONS?



VEHICLE SEARCH





Types of Vehicle Search

- Initial Check
- Primary Search
- Secondary Search



Vehicle Search

For insurgents vehicles can provide:

Delivery platform for large quantities of explosives

Concealment to a target

Contain large number of explosives in voids

- Boot
- Cargo compartment
- Under seats
- Dash
- Fragmentation



Vehicle Search

- Offensive Search
 - Find enemy resources in transit
 - Deter movement of enemy resources
- Defensive Search
 - Protect Friendly Forces and Resources
 - Protect Others
- Protect potential targets
- Gain a conviction in civil courts



Vehicle Search Categories

- Initial check
- Primary search
- Secondary search





Initial Check

Purpose

To identify vehicles for a more detailed examination

Reasons for initial check

- Large volume of vehicles (conduct random checks)
- Suspicious circumstances
- Intelligence gathering
- Discourages potential incidents from occurring





Initial Check

A search pair will perform the checks

- Normally requires about two minutes per vehicle
- One searcher to question driver
- One searcher checks the vehicle





Initial Check

What to look for on the initial check

- Facial expressions
- Overly polite
- Suspicious/out of place modifications
- Strong Smells
- Overloaded vehicle
- Keys present/missing
- Vehicle documentation



Primary Search

Is carried out on vehicles that have been selected during the initial check





Planning

Search should be as detailed as time and conditions allow

Search must be systematic

Takes approximately 10 minutes for a sedan type car

Ideally carried out by a search pair



Team Leader Responsibilities

Controls operation

Checks documentation

Removes occupants

Directs occupants to open all items

- Doors
- Bonnet
- Boot
- Glove box

Questions driver



Inside



Clean Pair



Inside Boot / Truck



Clean Pair



Engine



Dirty Pair



Outside



Dirty Pair



Underneath



Dirty Pair





Other Vehicles





Other Vehicles





Actions On

- Non-Life Threatening Find:
 - Item removed.
 - Search Completed.
 - Subject Arrested.

 - Life Threatening Find:
 - 5Cs
- Confirm-Clear-Cordon-Control-Call.



ANY QUESTIONS?



Detailed search of a suspicious vehicle

Requested from supporting agencies, reasons to request

- Explosive trace, but no explosives found

- Refusal of the driver to cooperate

- Individuals or vehicles on Be On the Look Out (BOLO) list

- Individuals engaged in criminal activities



Planning

Can take hours to days

Identified search location

Carried out by specialized search personnel

- Police
- Mechanics



Baggage Search

Carried out at any time during the process of a person search or a vehicle search, its process and principle is the same:

- Individual compartments should be checked
- The strap should be checked
- Check for false bottoms
- Check in the corners for any lumps or areas that do not feel normal
- Check any screws are not damaged as though the bag has been taken apart and put back together.



Person and Vehicle Search Reports

What should be noted down if conducting a search?

Time of Search

Authorised by

Location of Search

Persons being search / Vehicle Details

Person conducting the Search

Search results details



ANY QUESTIONS?



Summary

Conducting all type of search, in a legal and safe manner has multiple benefits, it will ensure the immediate safety of those conducting the search, it will ensure those conducting the search can not have allegation of a criminal nature pressed on them and it ensures if the searcher finds something that can be used in the court of law then the evidence is preserved and recorded with witnesses. Do not underestimate the power of conducting a search, this alone will be enough to put off many persons from carry or transporting items that are either illegal or could be used for illegal activities.



References

The following references are available to support this module:

- ANZCTC (2017). Improvised Explosive Device (IED) Guidelines for Crowded Places. Australia: Author
- Homeland Security: IED Search Procedures Overview. Retrieved from: https://na.eventscloud.com/file_uploads/2720d345f3a0ca6e71e173f07bed63ac_DH_SIEDSearchProcedures.pdf
- Multi-National Corps (2004). Improvised Explosive Devices, Smart Cards: ASOF27OCT2004. Iraq. Retrieved From: <https://info.publicintelligence.net/OIF-IEDSmartCard.pdf>
- UNMAS (2018). United Nations Improvised Explosive Device Disposal Standards. Document Reference no. 2018.05. New York. USA: Author



Look forward to...

**MODULE 2.3 –
Gender Considerations in
Search Operations**



All Arms Search Course (AASC)

Module 2.3

Gender Considerations in Search Operations



Introduction

- ❑ Gender equality is one of the 17 Sustainable Development Goals (SDGs) making gender cross-cutting issues in all spheres of life.
- ❑ Explosive weapons are used in most armed conflicts. The use of these weapons in populated areas results in civilian deaths and injuries destroys infrastructure and livelihoods and wreaks havoc on the lives of women, men, and children alike.
- ❑ While these weapons may be indiscriminate, the specific threats and impacts vary according to gender, age and other aspects of diversity.
- ❑ It is essential that Counter IED programs apply a gender lens as part of a comprehensive and inclusive approach to planning, implementing and monitoring programmes to ensure protection for all and to ensure that “no one is left behind.”



Objective

- At the end of this module the participant will be able to discuss gender dynamics in counter IED



Scope

- Conceptualizing gender and related terms
- Approaches in the gender debate – WID, WAD & GAD
- Gendered impacts of IEDs
- Conflict Related Sexual Violence (CRSV)
- Sexual Exploitation and Abuse (SEA)



- **Concept of Gender**



Brainstorm

What do you expect a real/ideal man or woman to be like/behave like?



Sex and Gender

- ❑ Sex - biologically defined and genetically acquired differences between males and females, according to their physiology and reproductive capabilities.
- ❑ It is a factor of nature which categorizes one as male, female or intersex.
- ❑ Gender - sociocultural expression of characteristics and roles that are associated with certain groups of people with reference to their sex and sexuality.
- ❑ It is a factor of nurture categorizing one as man, woman or transgender.
- ❑ Sex and gender are not binary.





Why Understand Gender?

- ❑ The concept of gender is vital, because, when it is applied to social analysis, it reveals how women's subordination (or men's domination) is socially constructed.
- ❑ As such, the subordination can be changed or ended. It is not biologically predetermined, nor is it fixed forever.

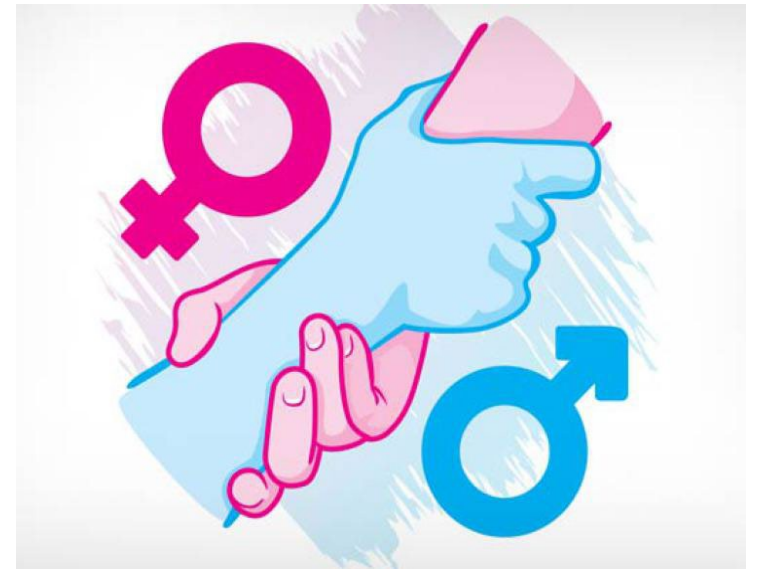



Gender versus Sex: The Differences

Gender	Sex
Cultural /social	Biological (e.g. hormones, chromosomes)
Learned through socialization (roles)	Determined at birth (e.g. genitalia)
Dynamic (varies in place, time etc.)	Universal
Can be changed	Cannot be changed (except with medical intervention)



Remember

- ❑ We are born either male or female then society makes us man or woman.
- ❑ Sex is between your legs while gender is between your ears.
- ❑ There is an interplay between sex and gender – they interact and mutually shape one another.
- ❑ Gender is intersectional: gender never acts alone to shape our behaviours - It always interacts with other factors such as race, ethnicity, religion, and economic status to affect our behaviours.



Gender Versus Sex Quiz

Is it gender or sex?

- 1. Women give birth to babies, men don't.**
- 2. Little girls are gentle, and little boys are tough.**
- 3. Boys do better in science; girls do better in arts and literature.**
- 4. Women can breastfeed babies, men can bottle-feed babies.**
- 5. Until late 2019, women in Iran were never allowed to watch soccer in stadiums.**
- 6. Women in Saudi Arabia have not been driving cars until 2017 when the ban was lifted.**
- 7. Women are disinherited of family property after the death of their husbands.**



Related to Gender

- Other Concepts



Gender Equity

- The provision of fairness and justice in the distribution of benefits and responsibilities between women and men.**
- For equity to be achieved, measures should be taken to compensate for the disadvantages that prevent women and men from operating on a level playing field (e.g. affirmative action strategies in education, employment, promotions etc.).**
- Equity leads to equality.**



Gender Equality

- ❑ Refers to the equal rights, responsibilities and opportunities of women and men and girls and boys.
- ❑ Equality does not mean that women and men will become the same but that women's and men's rights, responsibilities and opportunities, will not depend on whether they are born male or female.
- ❑ Equality is a right (Universal Declaration of Human Rights).

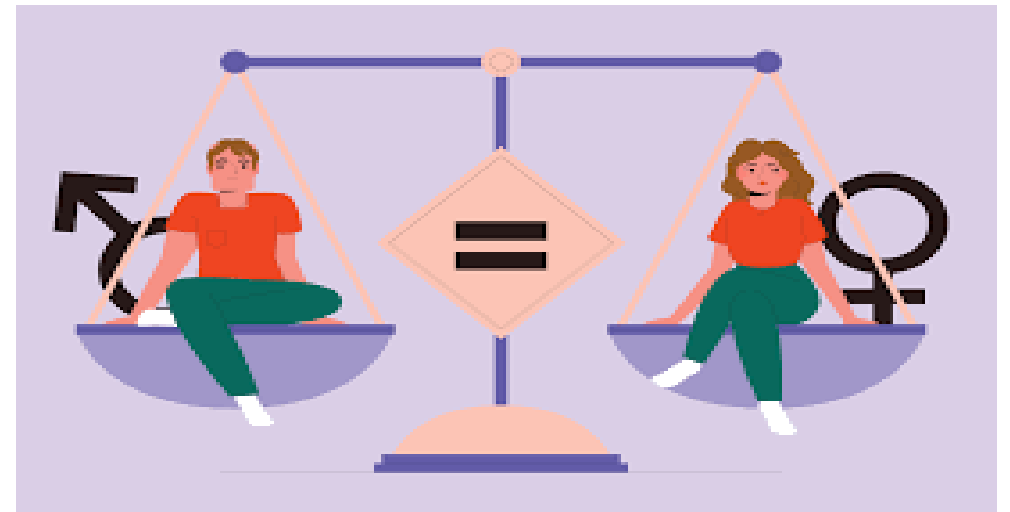



Equality Vs Equity

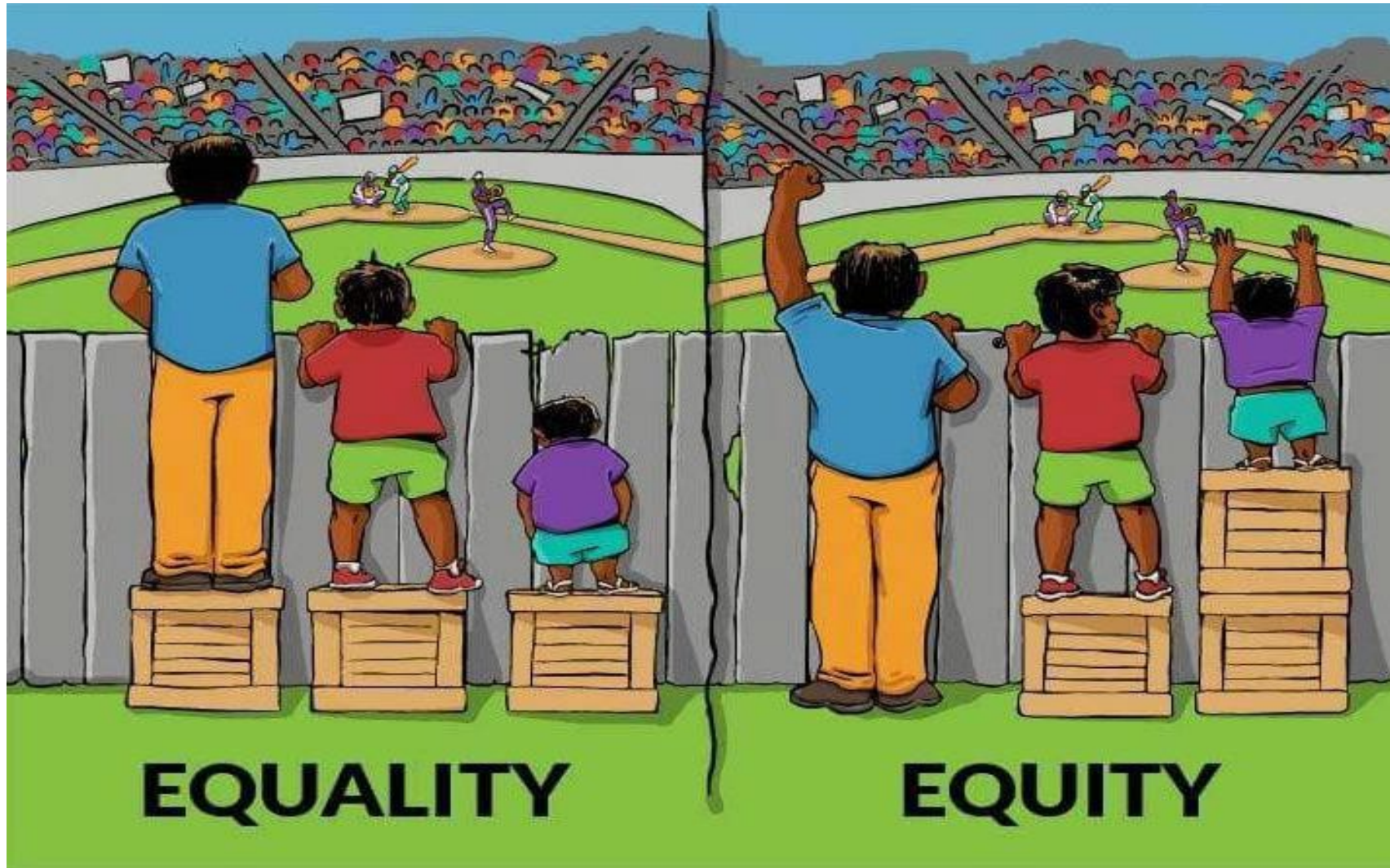



Gender Mainstreaming (GM)

- ❑ Gender Mainstreaming involves reorganizing, improving, developing and evaluating policy-making processes so as to incorporate a gender perspective in all policies at all levels and at all stages.
- ❑ Gender mainstreaming is both a political and technical process.



Gender Mainstreaming:

**Gender
mainstreaming**

Strategy

Method

to achieve

**Gender
equality**



Gender Mainstreaming Principles



Apply a gender lens to existing structures, processes and culture



Recognize needs and interests of women and men, girls and boys as different and equal



Women and men work together to rebalance access and control over resources and power



Political will, support and commitment from the top to lead and authorize process



Ownership and commitment by all stakeholders necessary for gender mainstreaming



Gender adviser/team/focal point to support and promote gender skills and approaches but overall responsibility for gender mainstreaming and implementation lies with all staff



All staff involved in implementation need to be gender-aware



Women in Development (WID); Women and Development (WAD) Gender and Development (GAD)

- Part II
- Approaches in the Gender Debate



The 3 Approaches

- Video: [WID-WAD-GAD TIMELINE](#)



The 3 Approaches

Figure- 1

GRAPHICAL REPRESENTATION OF WID APPROACHES/PERSPECTIVES

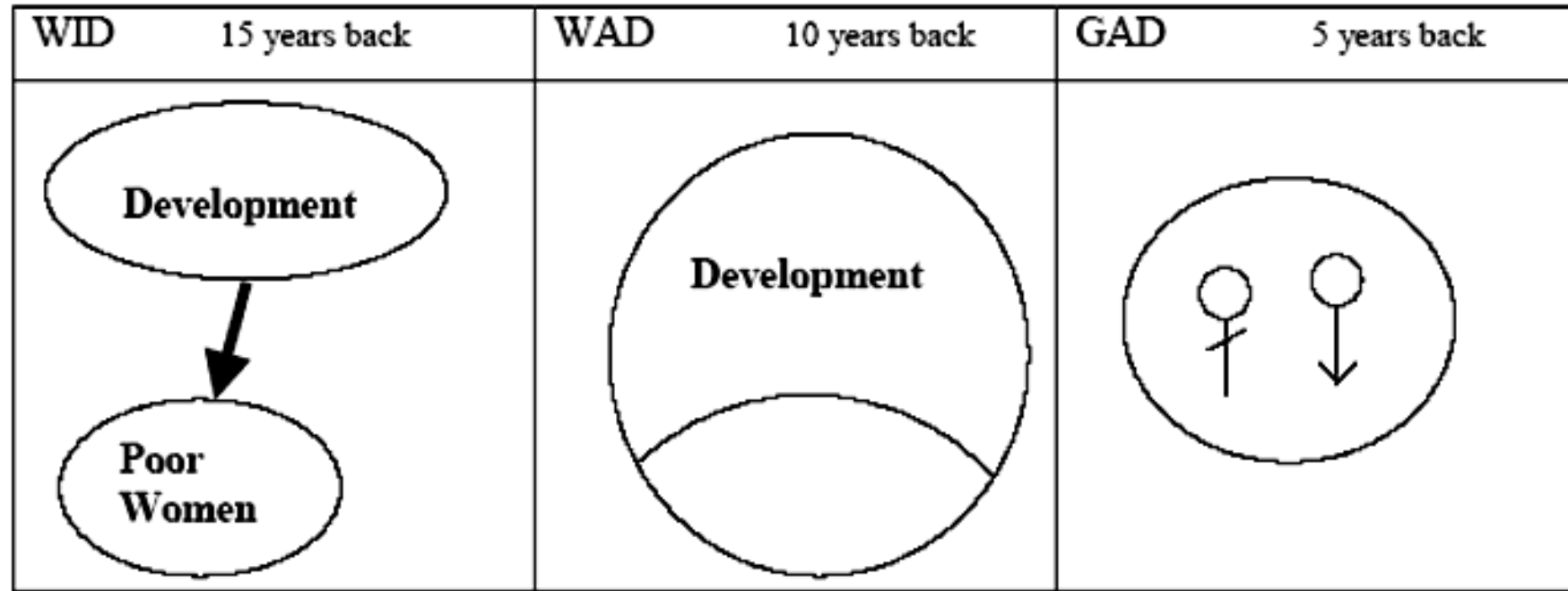

Women In Development

Integrating women whose needs were not addressed prior to that time in the development process.

Women And Development

Making women's role and work visible and recognising their contribution in the society.

Gender And Development

Addressing men and women's positions in the society to change control and access of women.



Gendered impacts of IEDs

- Part III



Some Gendered Impacts

- ❑ Attacks by explosive weapons in residential areas and markets can disproportionately affect women in contexts where they have the primary responsibility for buying food and household goods at markets.
- ❑ Physical trauma resulting in disabilities have differentiated impacts on women, men, girls and boys.
- ❑ Women with disabilities are often seen as a burden on their families and girls with disabilities are less likely to attend school.
- ❑ Men with disabilities can face economic discrimination as well as the loss of their social status.





Some Gendered Impacts...

- ❑ The resounding effects of life-altering injury ripple out across families and communities, including leading women and girls to take on additional caregiving roles and become the family's main provider.
- ❑ Destruction of schools can exacerbate gender inequalities and expose girls and boys to various risks, such as early marriages and recruitment into armed groups.
- ❑ Men face a higher risk of death and injury, comprising most direct casualties of explosive weapons attacks among civilians.
- ❑ Pregnant women face a higher risk of pregnancy-related complications, including miscarriages.
- ❑ Destruction of hospitals and disruption in health services increases maternal mortality.





Some Gendered Impacts...

- ❑ When schools reopen, girls are less likely than boys to return due to security perceptions and gender norms.
- ❑ Destruction of housing and other infrastructure often lead to the establishment of informal settlements and forced migration, exposing women and girls to higher risks of sexual abuse and gender-based violence.





WOMEN, PEACE AND SECURITY AGENDA



1325
women | peace | security



The story of UNSCR 1325



Precursor to WPS Agenda

- ❑ UN Charter (1945): *Recognized equal rights of men and women*
- ❑ UN Decade for Women (1975-1985)
- ❑ Convention on Elimination of All Discrimination Against Women (CEDAW) (1979)
- ❑ The 4th World Conference on Women, Beijing, China (1995). Identified 12 critical areas of concern (women in armed conflict is one the 12)
- ❑ Windhoek Declaration and the Namibia Plan of Action (June 2000) - *Mainstreaming of gender in multi-dimensional peace operations.*



The WPS Agenda

- ❑ As of October 2019, the UN Security Council had adopted ten (10) resolutions on “Women, Peace and Security”
- ❑ The resolutions are: 1325 (2000); 1820 (2008); 1888 (2009); 1889 (2010); 1960 (2011); 2106 (2013); 2122 (2013); 2242 (2015), 2467 (2019) & 2493 (2019)
- ❑ The ten resolutions make up the Women Peace and Security (WPS) Agenda



The WPS Agenda ...

- ❑ The ten UNSCRs on WPS establish international norms on:
 - ❖ The participation and representation of women at all levels of decision-making
 - ❖ The protection and promotion of women's and girls' rights.
 - ❖ The protection of women and girls from SGBV
 - ❖ Accountability and law enforcement
 - ❖ Gender-sensitive training.
 - ❖ The mainstreaming of gender perspectives in peace operations.



UNSCR 1325 (2000)

- ❑ The first UN Resolution to address the issue of women's inclusion in peace and security matters.
- ❑ It addresses two key points:
 1. The disproportionate and unique impact of armed conflict on women and girls.
 1. The crucial role that women and girls make to conflict prevention, peacekeeping, conflict resolution and peacebuilding.





The Pillars of UNSCR 1325 (2000)

Full and equal participation and representation of women at all levels of decision-making in peace processes

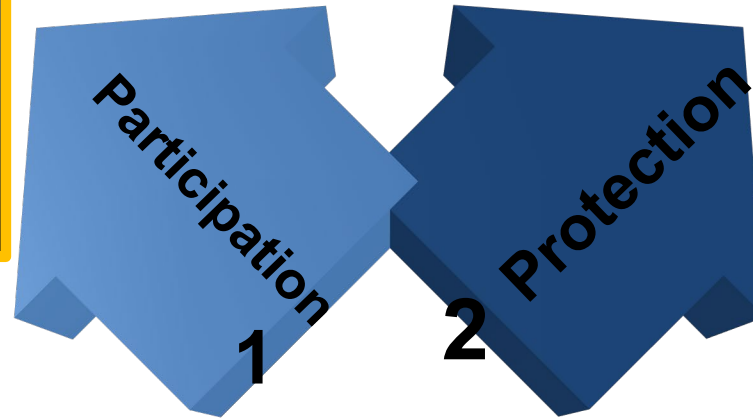

Protection from GBV, SEA and other violations of women's human rights

Gender perspective and the participation of women in preventing the emergence, spread, and re-emergence of violent conflict





General Gender Integration Considerations

- ❑ Acknowledge the gendered impacts of the use of explosive weapons in statements, resolutions and declarations.
- ❑ Include survivors and their representative organizations, as well as first responders and development actors, in international discussions on explosive weapons.
- ❑ Integrate the topic of explosive into the Women, Peace and Security debates in order to guarantee women's participation in efforts to protect civilians.

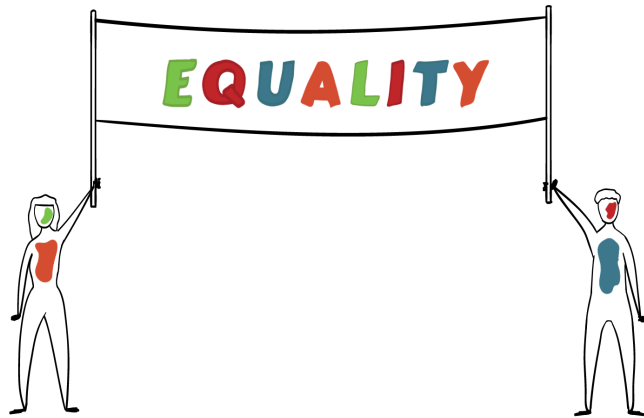



General Gender Integration Considerations

- ❑ Develop and fund mechanisms to collect and share sex- and gender-disaggregated data on the direct and indirect effects of explosive weapons.
- ❑ Provide gender-sensitive assistance to survivors, including in the form of trauma care, physical rehabilitation, psychosocial support and socio-economic reintegration.
- ❑ Apply a gender perspective in the implementation of existing obligations under International Humanitarian Law with regards to the use of explosive weapons and develop and share best practices for integrating gender in the civilian protection life cycle.





Working with Community

Gender considerations:

- Recruit the Right Personnel – ensure that community-facing teams can communicate effectively with everyone if required, including women, girls, boys, and men from diverse groups to enable active participation. Employ mixed gender teams.
- Identify the Best Time to Reach Target Groups – use data from the gender analysis to understand the daily schedules of different target groups; adjust community visit times/days accordingly.
- Consider the best locations in which to access targeted groups.





Working with Community...

Gender considerations:

- ❑ Gender-Sensitive and culturally-sensitive communication: gender norms, nonverbal communication, topics to avoid etc.
- ❑ Communicate in Local Language and with Visual Tools – literacy and language skills often vary based on a person's gender.





Gender considerations:

- ❑ Encourage active participation when men and women are in the same meeting or hold separate meetings for each gender category.
- ❑ Use Local Networks – when unable to access women or marginalised groups, collaborate with representative organizations, such as local women's groups, to access the target population effectively.





Conflict Related Sexual Violence (CRSV)

- Part IV



Scope

1. Film: *Combating CRSV – Prevent, Deter & Protect*
2. Definitions
3. Types of CRSV
4. Patterns/Trends
5. Potential victims
6. Perpetrators and Motives
7. Addressing CRSV in PSO
8. UN action against CRSV



Combating Conflict-Related Sexual Violence –
“Prevent-Deter-Protect”



Discussion Points

☐ From the video:

1. What is CRSV?
2. Why is CRSV an issue of concern in peace and security?
3. What are the different forms of CRSV?
4. Identify early warning signs of CRSV
5. Who perpetrates CRSV?
6. What are the motives for the perpetration of CRSV?
7. What is the role of different actors in prevention and response to CRSV- military, police, and civilian components.



Conflict Related Sexual Violence

- ❑ CRSV refers to violent acts of a sexual nature such as rape, forced pregnancy, forced sterilization, sexual slavery etc.
- ❑ For sexual violence to be considered conflict-related, there should be a **temporal, geographical or causal link**.
- ❑ CRSV rarely occurs in isolation. It is often perpetrated alongside other acts of violence such as killings, child recruitment into armed groups, looting, or destruction of property.



CRSV...

- ❑ CRSV frequently occurs when undisciplined militaries, police forces, or other armed groups believe they can act with impunity against vulnerable individuals.
- ❑ CRSV is prevalent during and after armed conflict and is common within fragile states.
- ❑ While CRSV is often assumed to be directed against women and girls, CRSV also includes assaults against men and boys.



Why Special Attention to CRSV

- ❑ In peace support operations, we should pay special attention to SV in conflict because:
 1. The vice is prevalent in conflicts and used as a tactic of war
 2. It has a gender dimension - increased risk for women and girls during conflict
 3. Culture of impunity is rampant in conflict situations
 4. SV in conflict has grave effects on survivors





Patterns and Trends

- ❑ CRSV usually happens during:
 - Targeted attacks against community settlements
 - Attacks on religious or cultural institutions and monuments
 - Attacks on IDP or refugee camps or protection sites and safe havens
 - Ambush of women and girls during routine daily tasks
 - House-to-house house searches
 - Abduction, kidnapping, hostage-taking





Potential Victims

❑ Broadly, CRSV victims are:

- Rival socio-politico-ethnic-religious individuals/groups
- Other groups (disabled, elderly, orphans, detained persons, IDPs, refugees, LGBTI)





Perpetrators

□ Perpetrators primarily include:

a. State actors - civil/military/police/gvt officials

b. Non-State actors - armed actors/groups, militias, organised criminal networks, former combatants.





Early Warning Indicators



Early-Warning Structure



Early-warning indicators on CRSV:

- Disappearance.
- Political Rhetoric.
- Fleeing/evacuating.
- House raids and searches.
- Tell-tale marks of violation.
- Silence or fearful disposition.
- Detention at camps & check points.
- Increased hospital reporting of rape.
- Movement of troops after victory/defeat.
- Proximity of armed groups to Civilian centres.
- Information from human & electronic sources.
- Frequent forays to villages by individual/few soldiers.
- Changed mobility patterns, particularly women & children.
- **Reporting** of threats/incidents to the authorities or communities.
- Ambushes, waylaying, isolated attacks, firewood/water rape & looting/ pillaging.



Motives

- To control a population through terrorizing and intimidation
- To control territory - vital terrain, cities, trade routes – including through forced displacement
- To control natural resources, e.g. mining areas
- To deliberately target ethnic or religious communities (political repression, sectarian violence, ethnic cleansing, dehumanization)
- To humiliate men and women through rape and incest in the presence of family or community members



Addressing CRSV in PSO

1. Deploy a critical mass of female personnel in PSO
2. Support host nation and civil society to address CRSV and strengthen national ownership
3. Be proactive - Pay attention to Early Warning Indicators of threats
4. Protect the civilians via patrols, cordon and search; escorts
5. Implement Quick Impact Projects (QIPs)
6. Monitor and verify incidents of CRSV (MARA-WPAs)





Sexual Exploitation and Abuse (SEA)

- Part V



Learning Activity

Video: To serve with pride



What is SEA?

Definition of Sexual Exploitation and Abuse (SEA)

ST/SGB/2003/13

- Sexual exploitation: Actual or attempted abuse of a person's vulnerability, differential power or trust for sexual purposes, including profiting monetarily, socially or politically from the exploitation
- Sexual Abuse: Actual or threatened physical intrusion of a sexual nature, by force or under unequal or coercive conditions

Sexual Exploitation and Abuse constitute serious misconduct for all UN personnel





Standards

Uniform Standards on Sexual Exploitation and Abuse

1. Sexual activity with children (persons under the age of 18) is prohibited
2. Exchange of money, employment, goods, assistance or services for sex, e.g. sex with prostitutes, is prohibited
3. Use of children or adults to procure sexual services for others is prohibited
4. Sexual relationships with beneficiaries of assistance are strongly discouraged





Addressing SEA

1. Prevention of misconduct

(i.e. policies, guidelines, awareness-raising , focal groups, and training to prevent SEA)

Your role and responsibility to prevent SEA:

2. Enforcement of UN standards

(i.e. zero tolerance, investigation, follow-up, repatriation of perpetrators)

- ✓ Immediately report suspected misconduct;
- ✓ Cooperate with UN investigations

3. Remedial action

(i.e. providing support to the victim, protecting whistle-blowers, being transparent and accountable)



Know the Rules

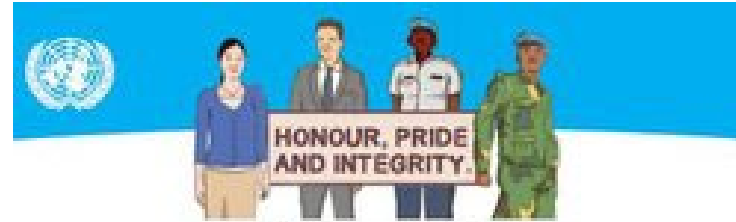

Sexual Exploitation and Abuse

KNOW THE RULES: THERE IS NO EXCUSE!

- 1 At all times we must treat the local population with respect and dignity.
- 1 Sexual exploitation and abuse is unacceptable behaviour and prohibited conduct for all United Nations and affiliated personnel.
- 1 Sexual exploitation and abuse threatens the lives of people that we are to serve and protect.
- 1 Sexual exploitation and abuse undermines discipline, and damages the reputation of the United Nations.

EVERY PERSON UNDER THE UNITED NATIONS FLAG MUST COMPLY WITH THE FOLLOWING PROHIBITIONS:

- 1 It is **strictly prohibited** to have any sexual activity with anyone under the age of 18 years (regardless of the age of majority or age of consent locally or in my home country). Mistaken belief as to the age of the person is no excuse.
- 1 It is **strictly prohibited** to have sex with anyone, in exchange for money, employment, preferential treatment, goods or services, whether or not prostitution is legal in my country or the host country.
- 1 It is **strictly prohibited** to engage in any other form of sexually humiliating, degrading or exploitative behaviour.

fully understand that:

- 1 Involvement in any act of Sexual exploitation and abuse will be investigated and prosecuted if warranted.
- 1 Any proven act of Sexual exploitation and abuse will result in measures that can include but are not limited to: suspension, immediate repatriation, dismissal, imprisonment and a ban from future United Nations employment.
- 1 If I witness Sexual exploitation and abuse behaviour by others, regardless of their position or seniority, I have a responsibility to take all reasonable measures to stop the misconduct and report the incident immediately to my commander or manager.
- 1 Failure to respond or report misconduct is a breach of the United Nations standards of conduct. **There is no excuse!**

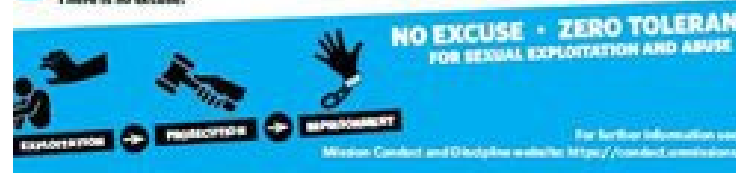



UN Action Against SEA

- Video: [Zero tolerance on SEA – UN SG statement](#)



Conclusion

- ❑ Sex and gender are important factors to understand the consequences of explosive weapons, CRSV and SEA.
- ❑ Knowledge about the different risks and vulnerabilities faced by women, men, girls and boys can inform prevention and protection strategies, as well as response and recovery efforts including assistance to survivors.
- ❑ Addressing the gendered implications of the direct effects of IEDs, CRSV and SEA will enable more sustainable relief and recovery efforts, ultimately enhancing the security and well-being of states and people.
- ❑ Protecting civilians from direct and deeply gendered effects of IEDs, CRSV and SEA will strengthen the implementation of the WPS agenda and the 2030 Agenda for Sustainable Development, particularly Sustainable Development Goal 5 on gender equality.
- ❑ Peace operations personnel are thus urged to embrace a gender perspective in the planning process for interventions.



Look forward to...

**MODULE 2.4 –
Introduction to Route
Search**



All Arms Search Course (AASC)

Module 2.4 Introduction to Route Search



Range

- Time
- Safety
- Questions
- Notes
- Phones/Devices
- Food/Drink
- Previous knowledge
- Assessment



Module Objective

At the end of this module, participants will be able to effectively conduct a route search.



Teaching Points Covered

- Why the need for Route Search
- Phases of a Single Team Route Search
- Action on
 - Command Wire
 - Find
 - ECM Failure
 - Restricted Isolation
- Support to EOD



The Need for Route Search

The purpose of Route Search is to:

- Locate terrorist resources and IEDs:
- Provide protection to convoys and troops
- Protect the local populace
- Provide an overt deterrent
- Prevent the enemy from achieving his intent:
 - Kill or injure
 - Destroy vehicles
 - Stop you using that route
 - Cause mayhem



The Need for Route Search

REMINDER – Threat on the Routes:

- Mines





The Need for Route Search

REMINDER – Threat on the Routes:

- Mines
- VOIED
i.e PPIED





The Need for Route Search

REMINDER – Threat on the Routes:

- Mines
- VOIED
- CWIED





The Need for Route Search

REMINDER – Threat on the Routes:

- Mines
- VOIED
- CWIED
- CPIED





The Need for Route Search

REMINDER – Threat on the Routes:

- Mines
- VOIED
- CWIED
- CPIED
- RCIED





The Need for Route Search

REMINDER – Threat on the Routes:

- Mines
- VOIED
- CWIED
- CPIED
- RCIED
- Combination or HOAX





The Need for Route Search

ANY QUESTIONS?



Phases of a Route Search

Route Search is built upon existing basic skills:

- Ground Sign Awareness
- 5/25m Checks
- Route Check
- And 5Cs operations

There are two key types of route search:

- Route Search
 - **Single Team**
 - Double Team
- Sp to EOD or IEDD





Phases of a Route Search

REMINDER - Route Check

...is conducted by basic Search trained troops and involves the Search of identified VPs and VAs where no specific IED threat exists (in relation to the location). It is a maneuver action, and no Search documentation is required for this type of operation.

It can be used by you on your way to a Search Task



Phases of a Route Search

Where is route search carried out?

Where **specific** intelligence exists to support a **high threat** from EO or a **high level of assurance** is required then a specially trained Search team should be deployed



Phases of a Route Search

Phases of Route Search:

1. Stop Short Procedure (Arrival)
2. Domination
3. Temp Halt (to form the Incident Control Point)
4. Isolation Party (flat fig-of-8)
5. Road Party



Phases of a Route Search

Phase 1 – Stop Shot Procedure:

- Selected by Search Advisor (SA)
- Search Teams conduct 5 and 25m checks
- Maybe co-located with the Cordon Commander's ICP
- SA liaises with the Cordon Comd and asks the 3 Q's?
 - Is the cordon in place as per the plan?
 - Has the situation changed or has any further J2 been received which may affect the search?
 - Describe the tactical conditions since your arrival?



Phases of a Route Search

Phase 2 – Domination:

- Force protection vehicles pushing out to the flanks of the convoy to:
- Offer protection to the troops carrying out search procedures.
- Deter/stop any possible command devices by dominating firing points.



Phases of a Route Search

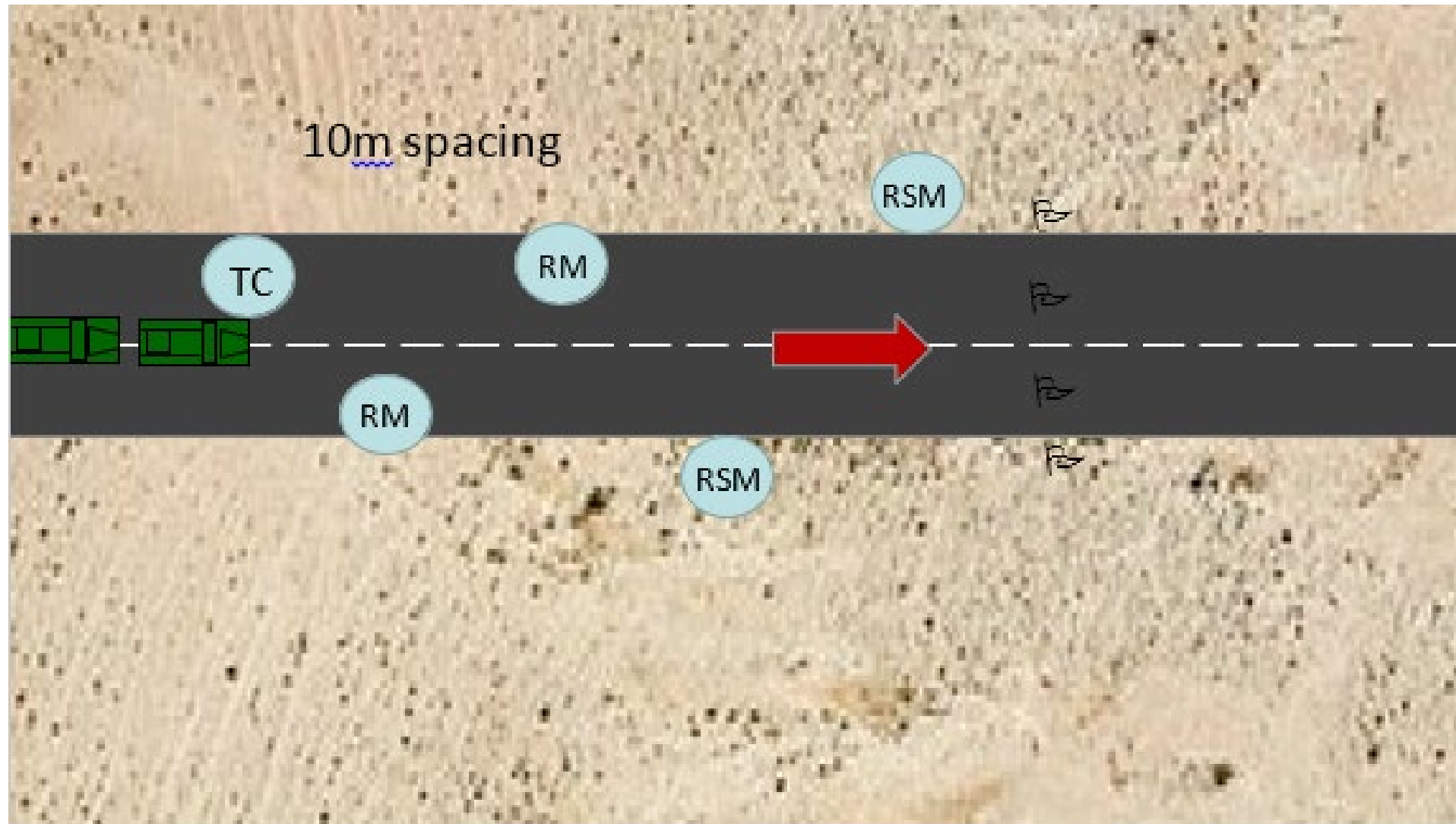



Phase 3 - Temporary Halt Procedure:

Used to establish an ICP

- At the start of the search to establish ICP 1
- Before any 2nd crossover to establish all subsequent ICPs



Phases of a Route Search

Conducting a Temporary Halt





Phases of a Route Search

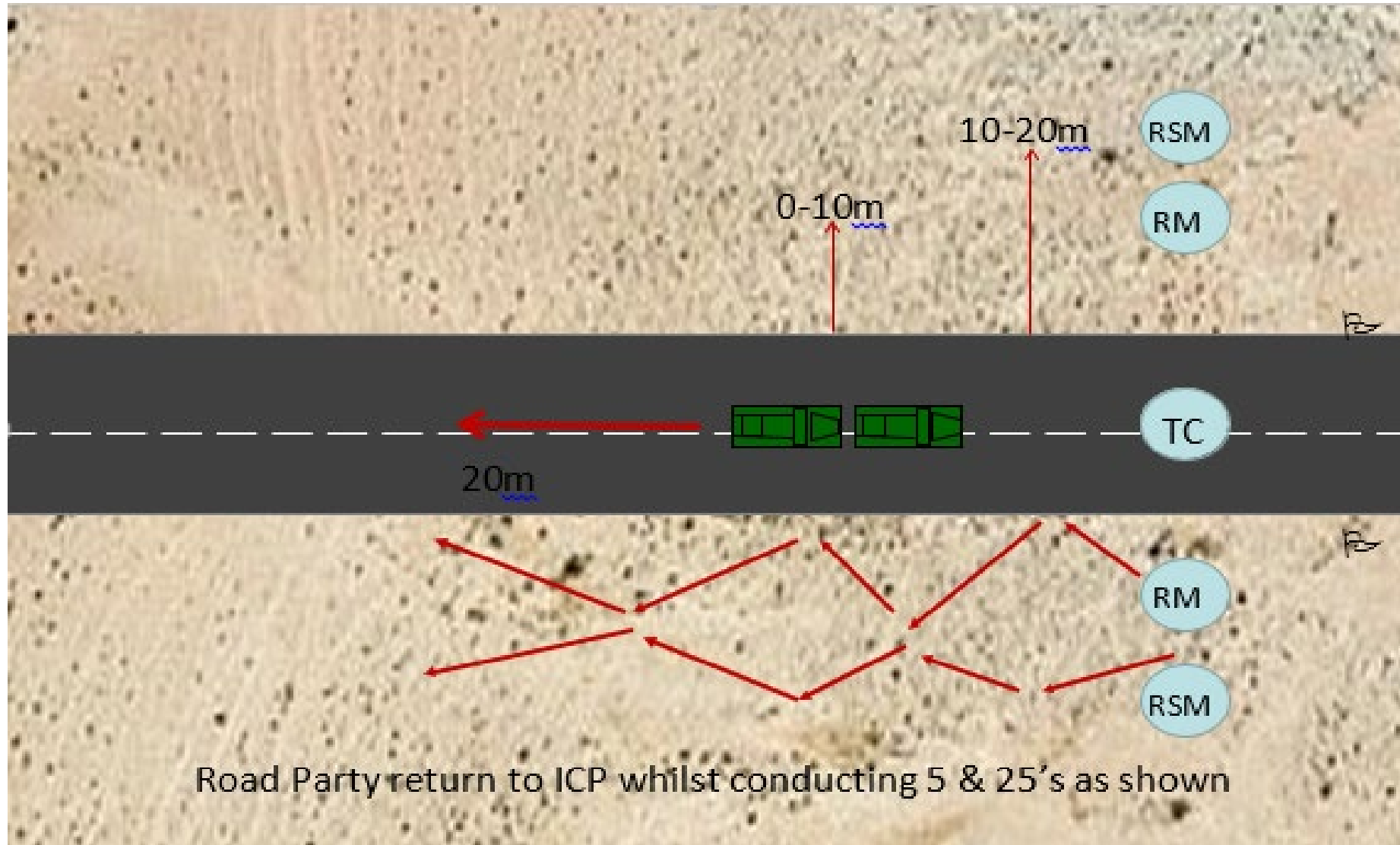



Phases of a Route Search





Phases of a Route Search

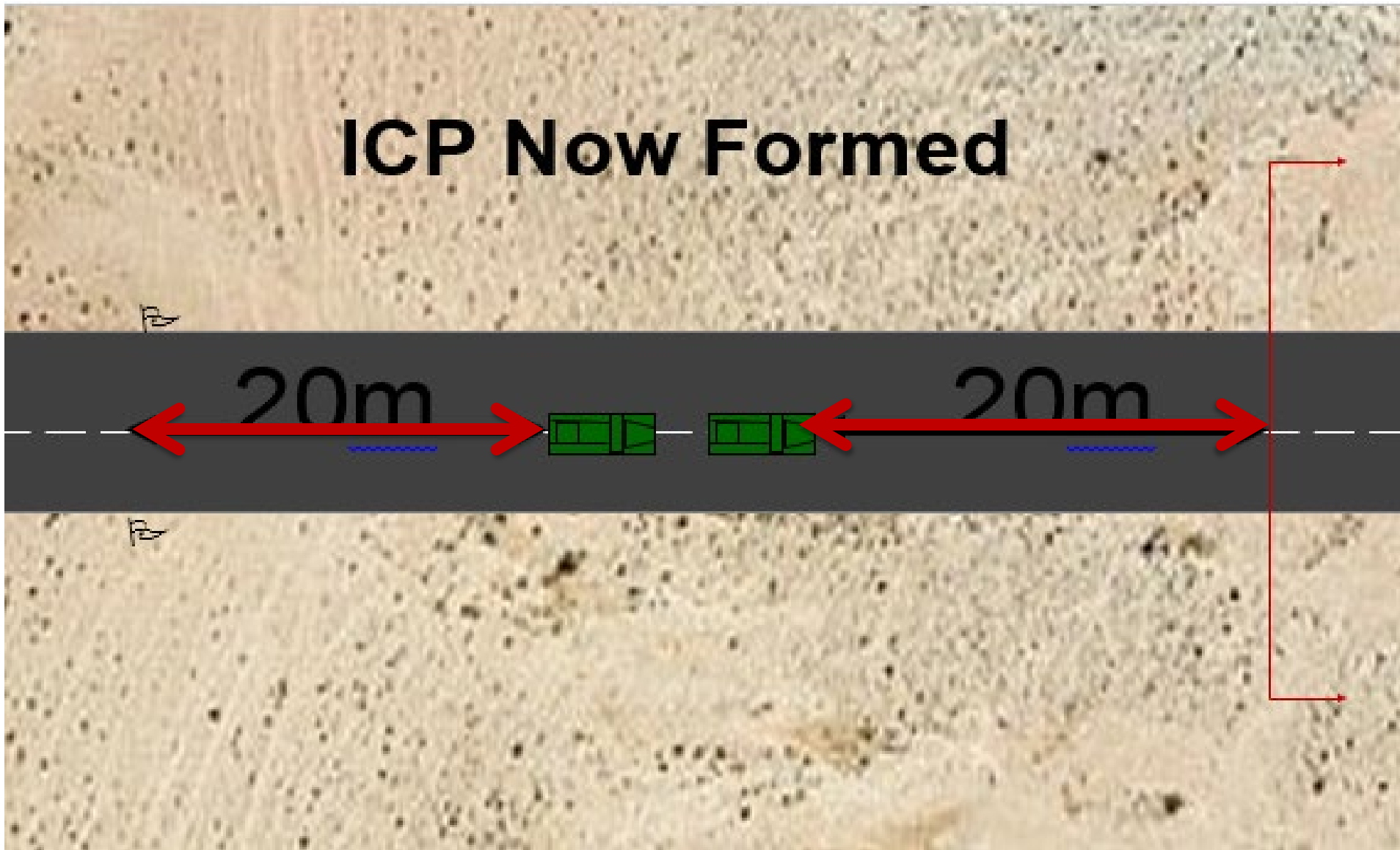



Phases of a Route Search

Phase 4 – Isolation Party

Purpose:

- To locate CW running into or parallel with the route
- Provide remote observation of the VP
- To identify potential Firing Points or En Scouts

ST form up as an Isolation Party to conduct a Flat Fig-8

- Infantry Escorts may be required to carry ECM



Phases of a Route Search

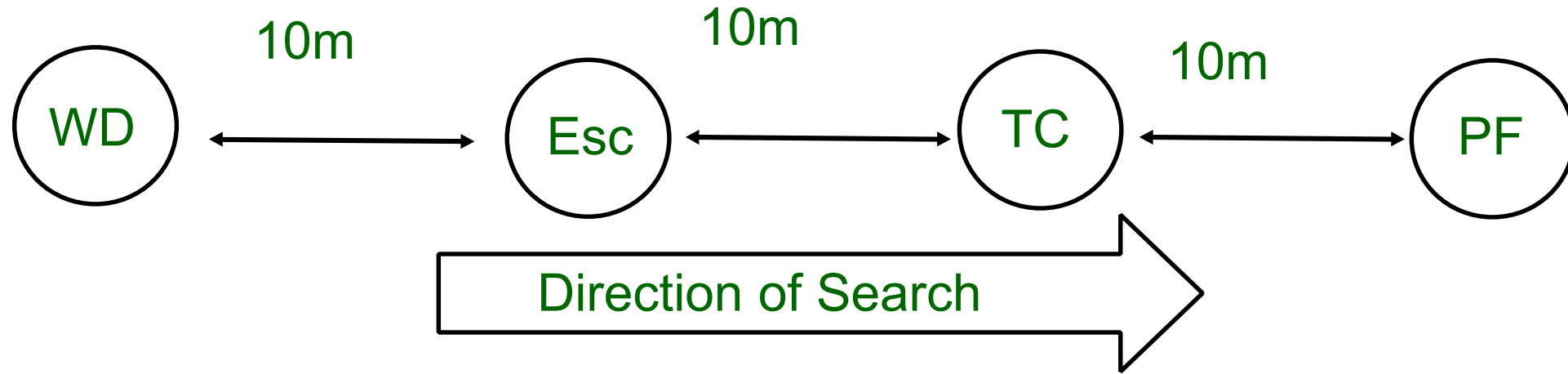

Wire Detector
Man – to hook for
command wires

Escort – To
provide security
and carry ECM
(can be more than
1)

Team Comd – To
select a route and
provide command
and control

Pathfinder - To
search a safe
route for the
Isolation Party -
Best searcher?



Phases of a Route Search

Pathfinder Equipment

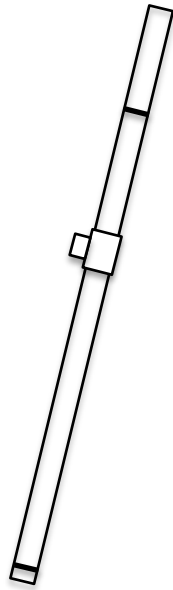

Issued Detector



Viewing Aid



Marking and Extraction Kit

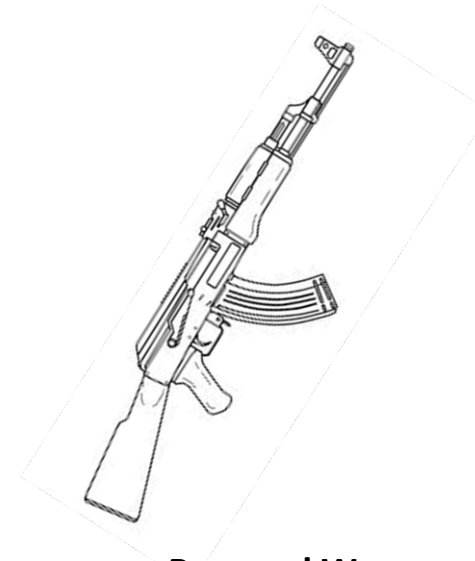

Personal Weapon



Phases of a Route Search

Team Commander Equipment



GPS



Viewing Aid

Radio

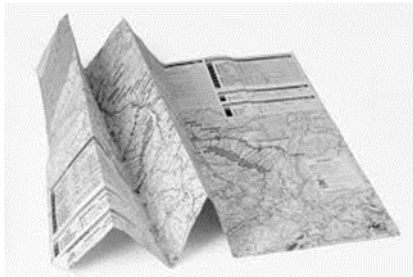

Map/Air Photo



Marking and Extraction Kit

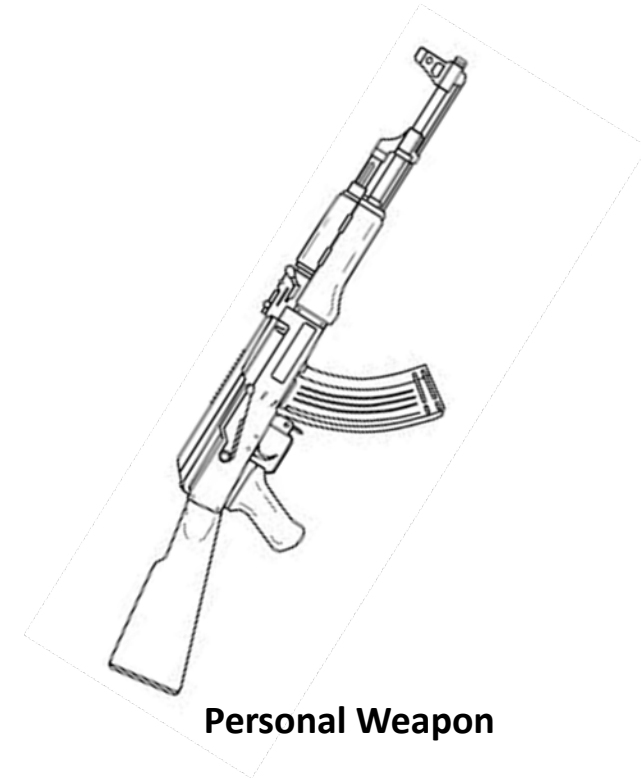

Personal Weapon



Phases of a Route Search

Wire Detector Man Equipment

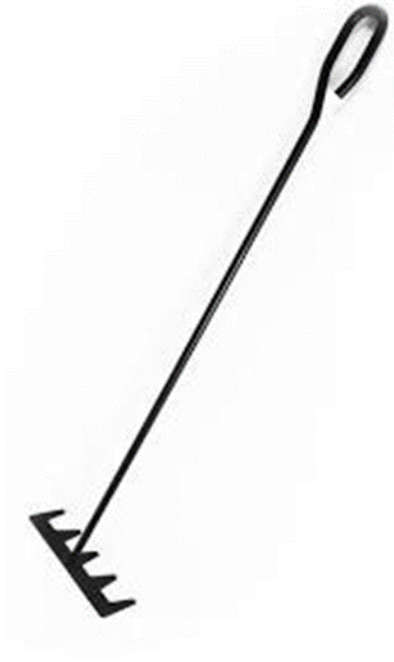

Drag Hook



Marking and Extraction Kit

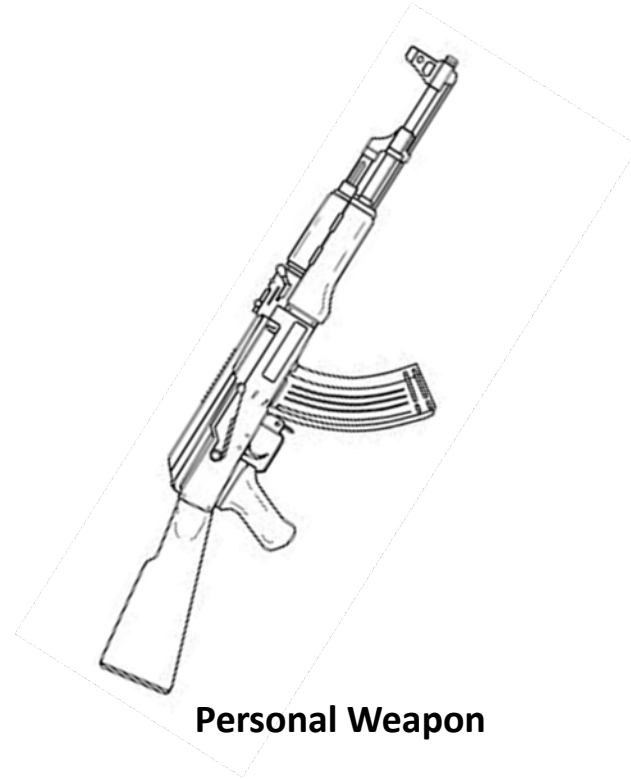

Personal Weapon



Phases of a Route Search

Escort Equipment



ECM Kit



Marking and Extraction Kit

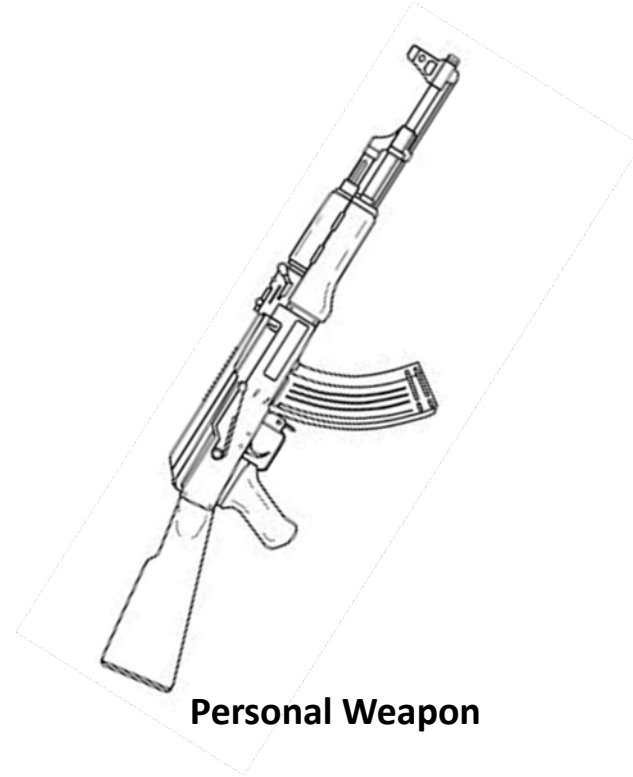

Personal Weapon



Phases of a Route Search

Phase 4 – Isolation Deployment

- Isolation Party forms up at rear of ICP
- All equipment is checked by Scribe
- Isolation Party deploys from the rear of ICP
- The party moves out to a 50 -75m from route
- The party then moves in direction of search and completes a flat figure of 8 isolating the route
- To mitigate the threat from CW running parallel with the route



Phases of a Route Search

Isolation Party: Flat Figure of 8

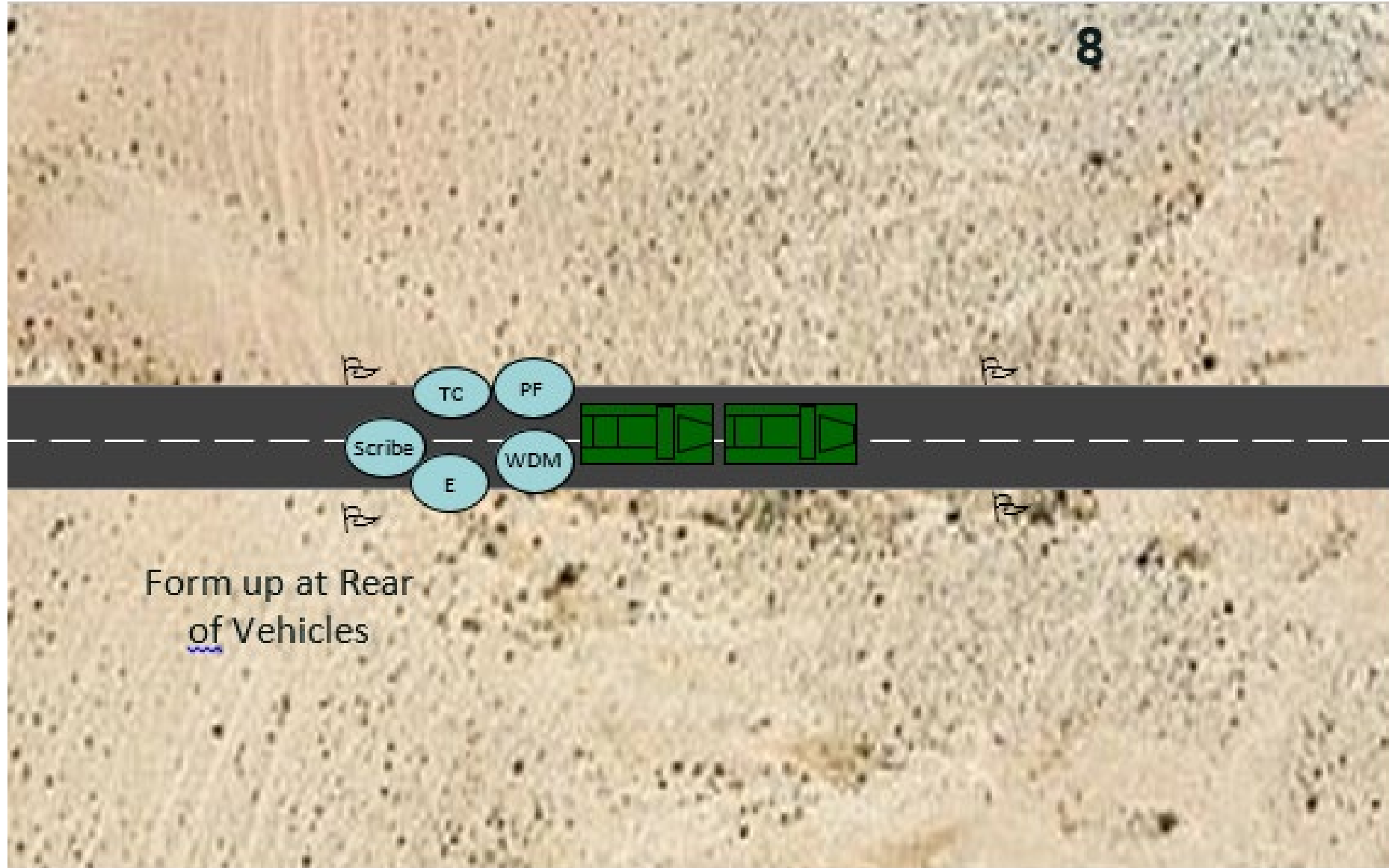



Phases of a Route Search

Isolation Party: Flat Figure of 8

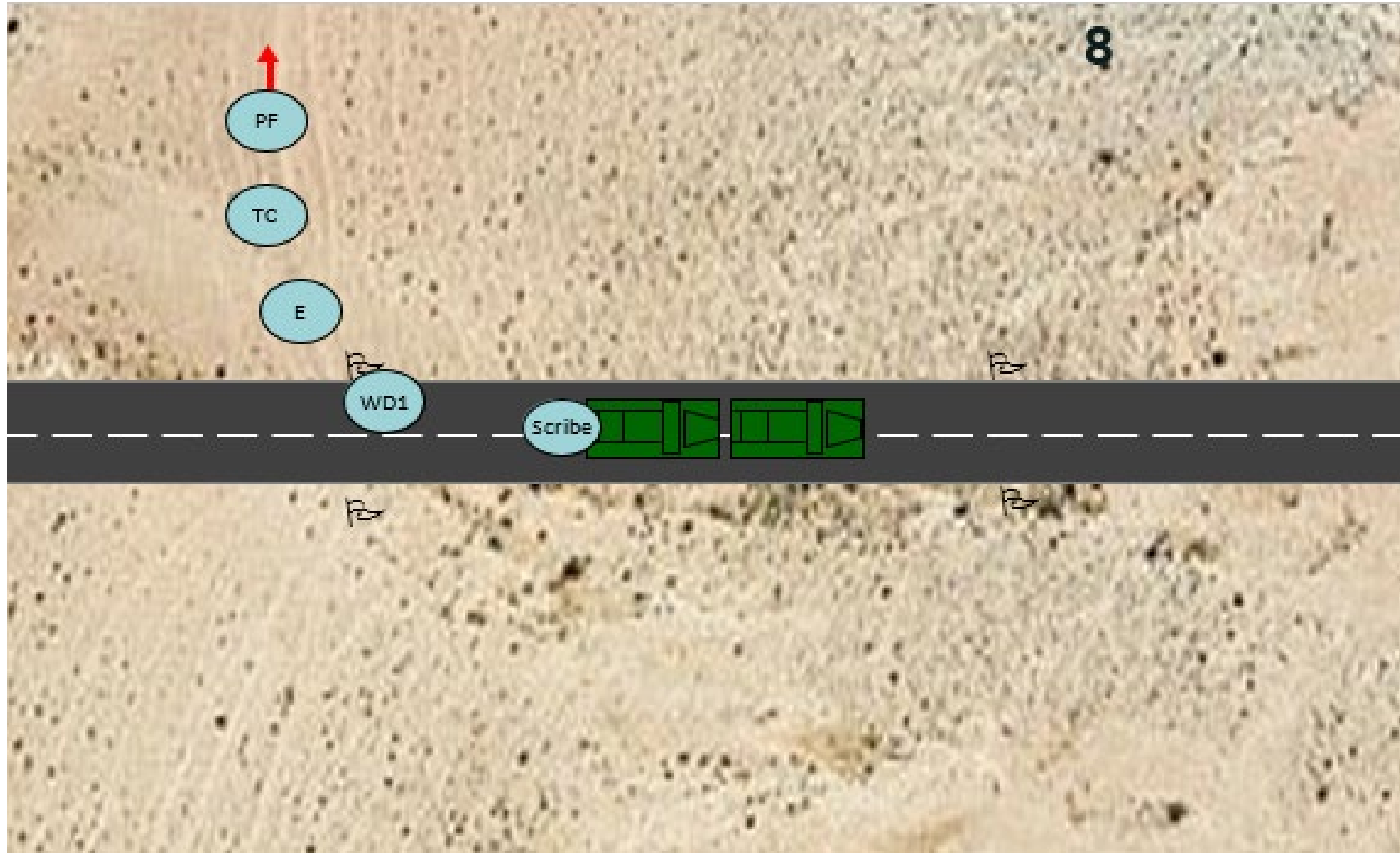



Phases of a Route Search

Isolation Party: Flat Figure of 8

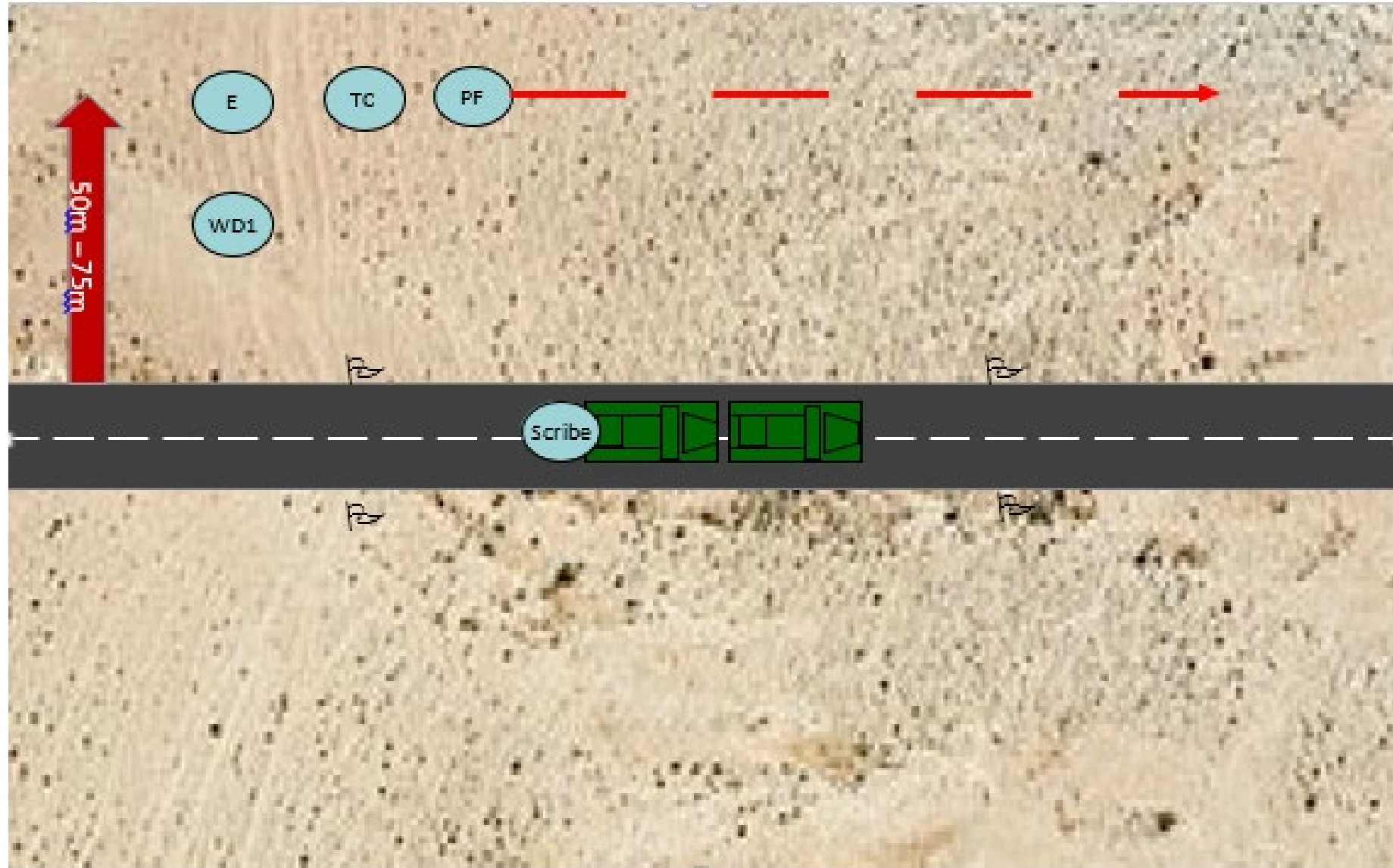



Phases of a Route Search

Isolation Party: Flat Figure of 8

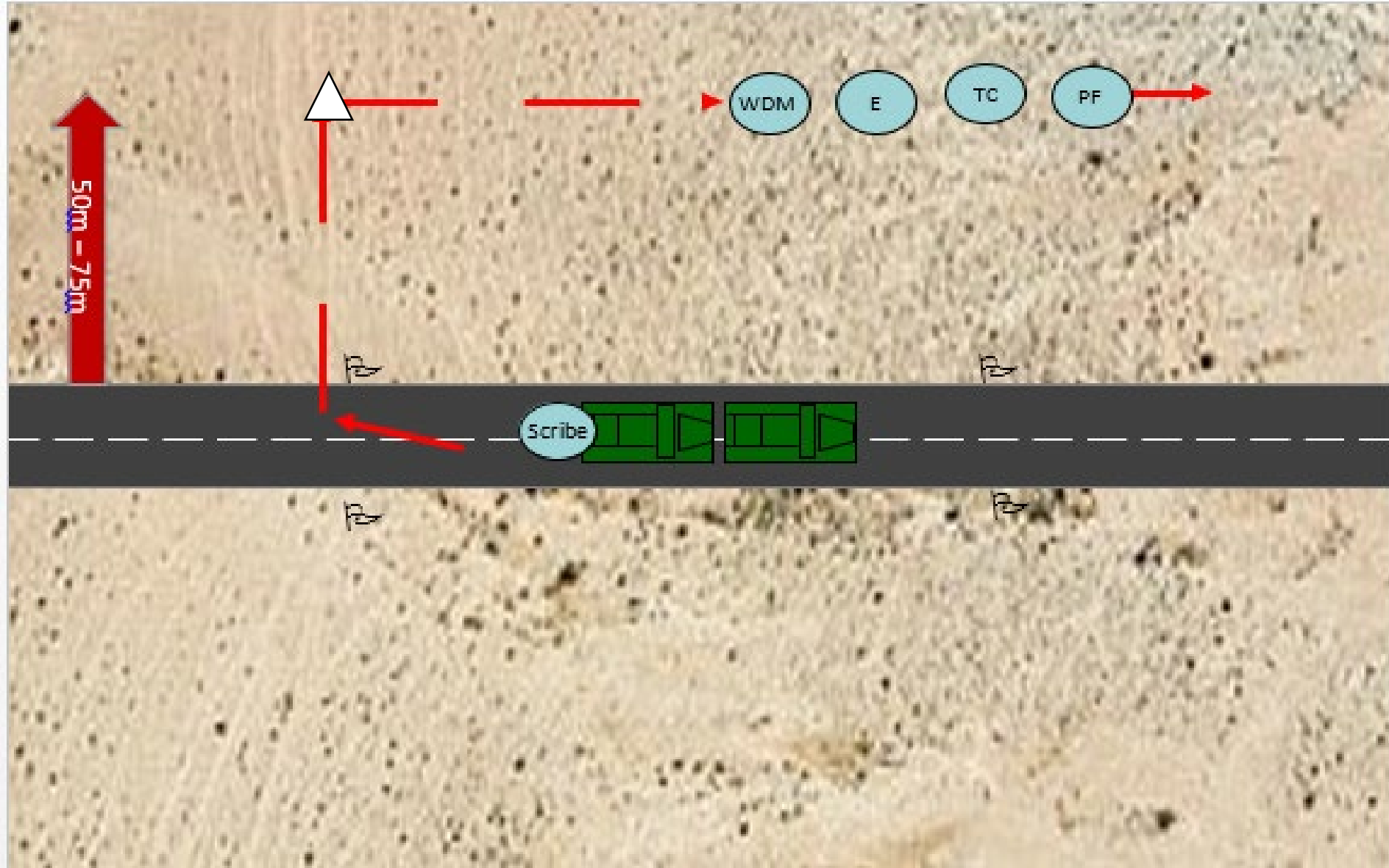



Phases of a Route Search

Isolation Party: Flat Figure of 8

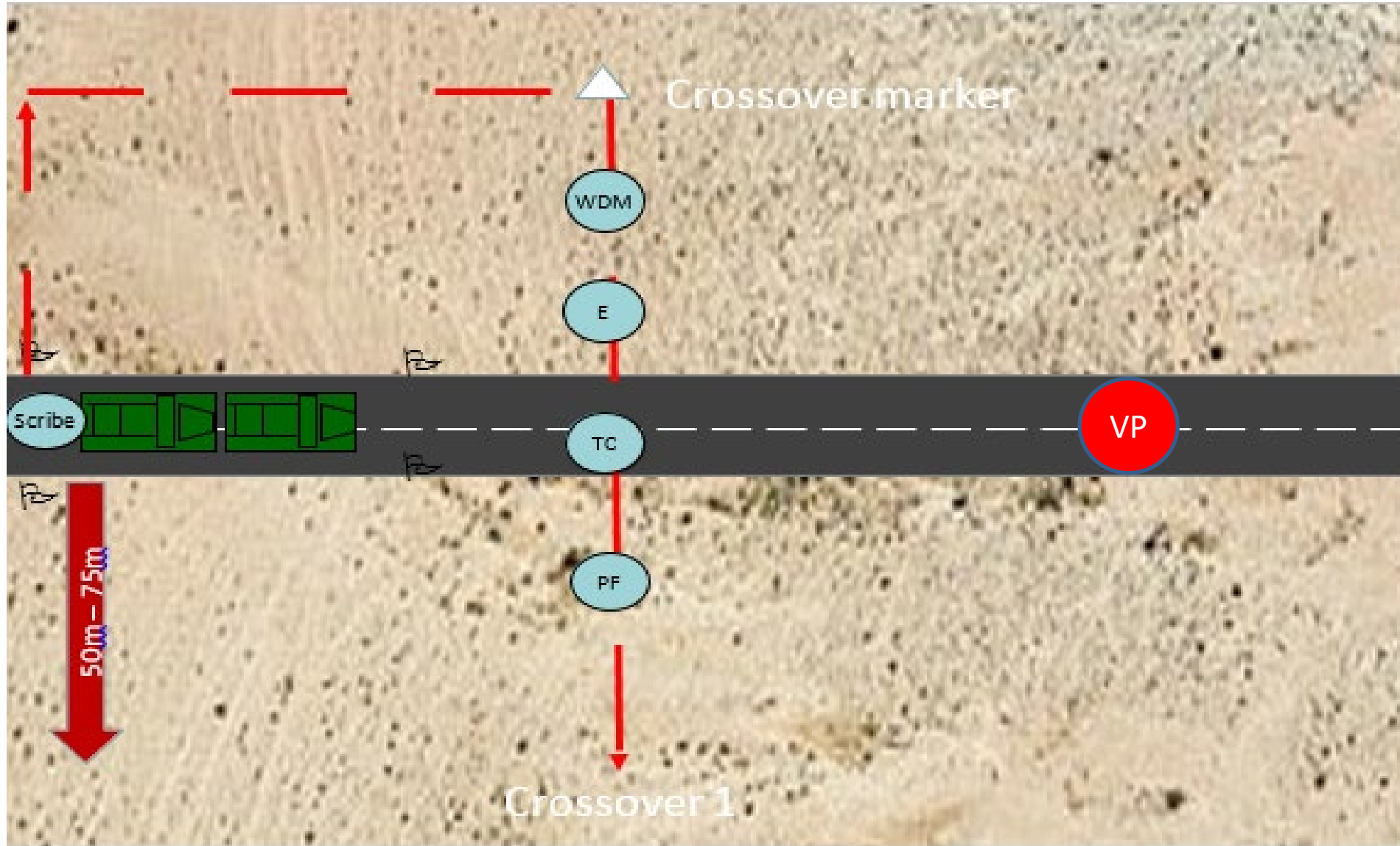



Phases of a Route Search

Isolation Party: Flat Figure of 8

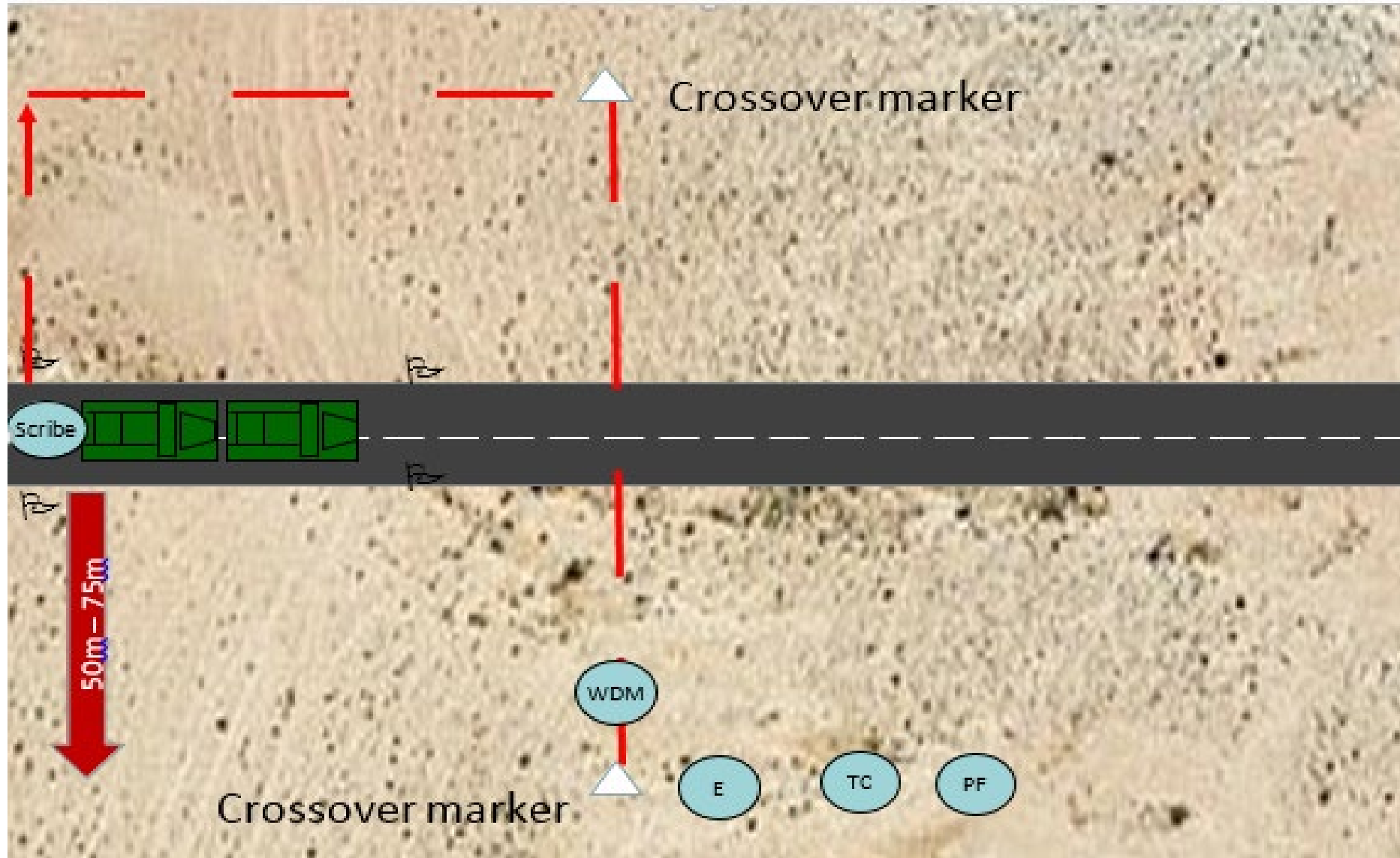



Phases of a Route Search

Isolation Party: Flat Figure of 8

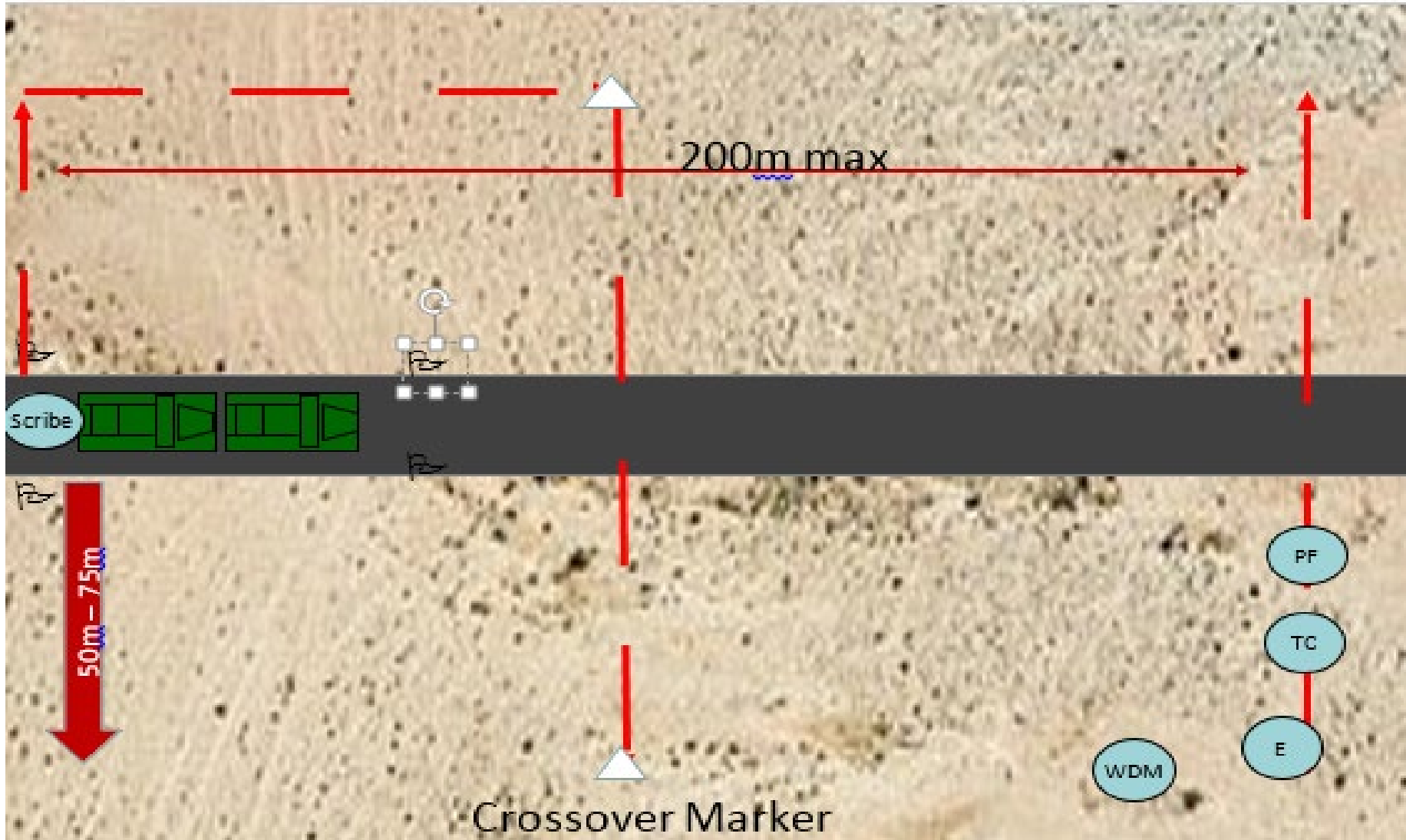



Phases of a Route Search

Isolation Party: Flat Figure of 8

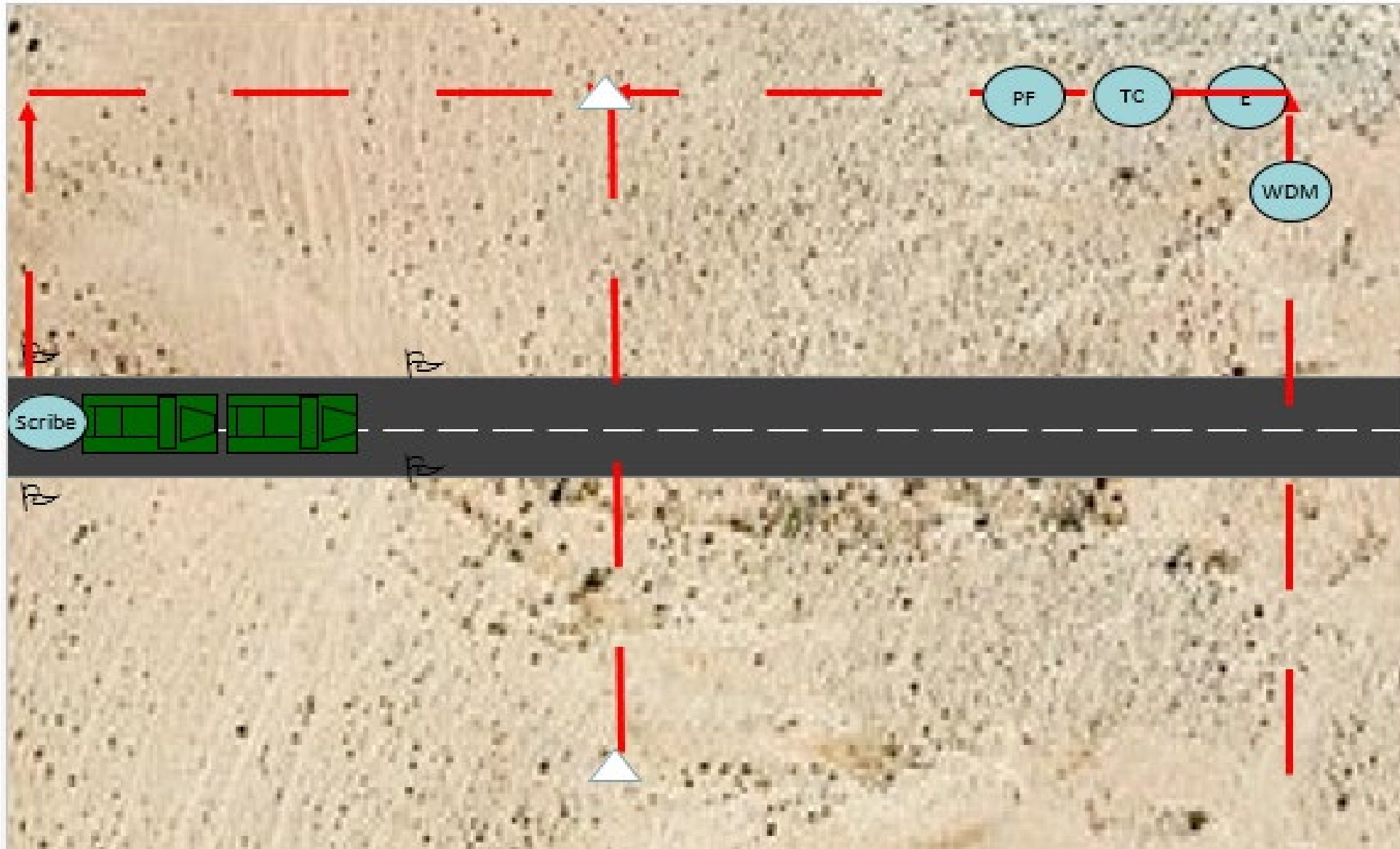



Phases of a Route Search

Isolation Party: Flat Figure of 8

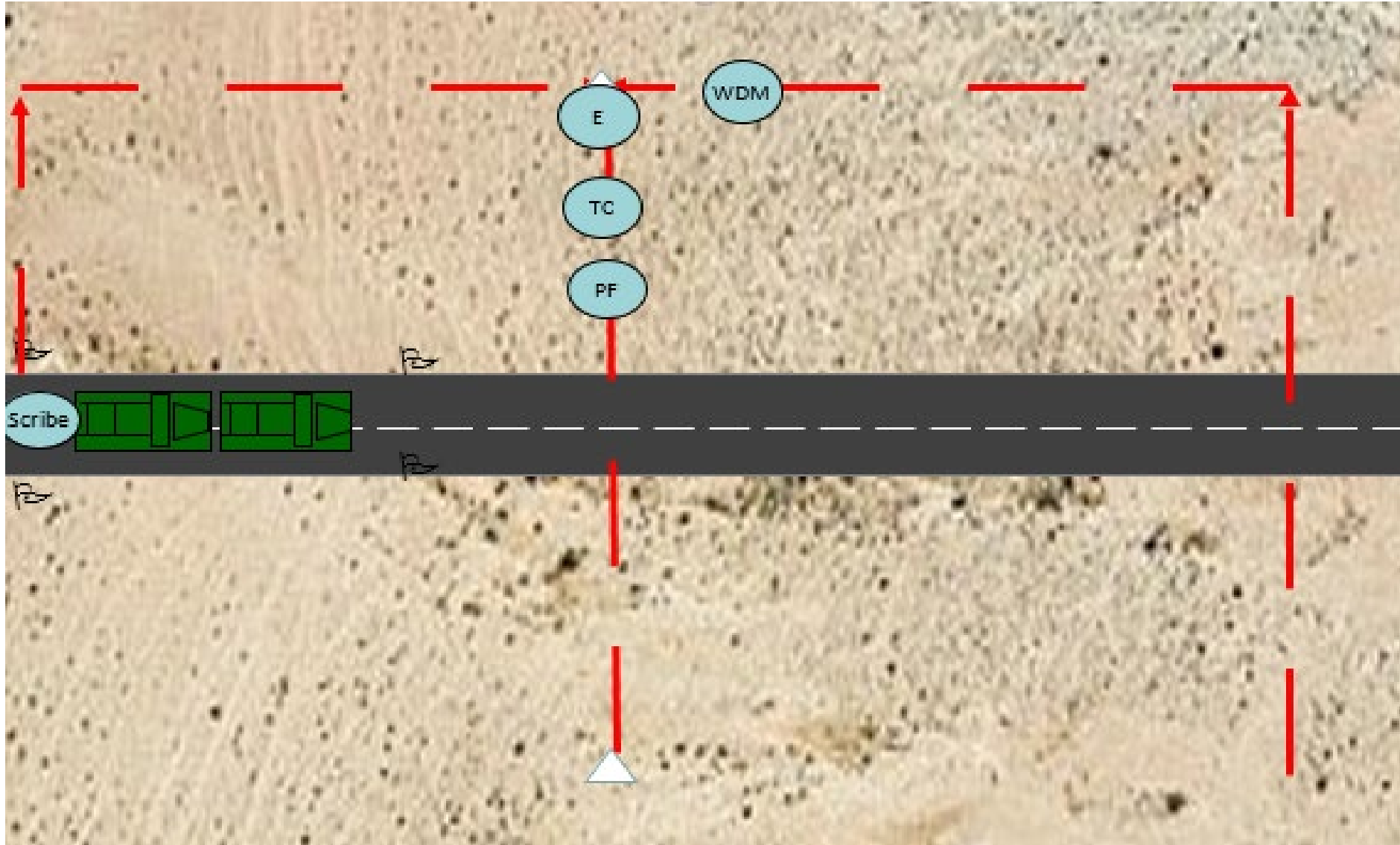



Phases of a Route Search

Isolation Party: Flat Figure of 8

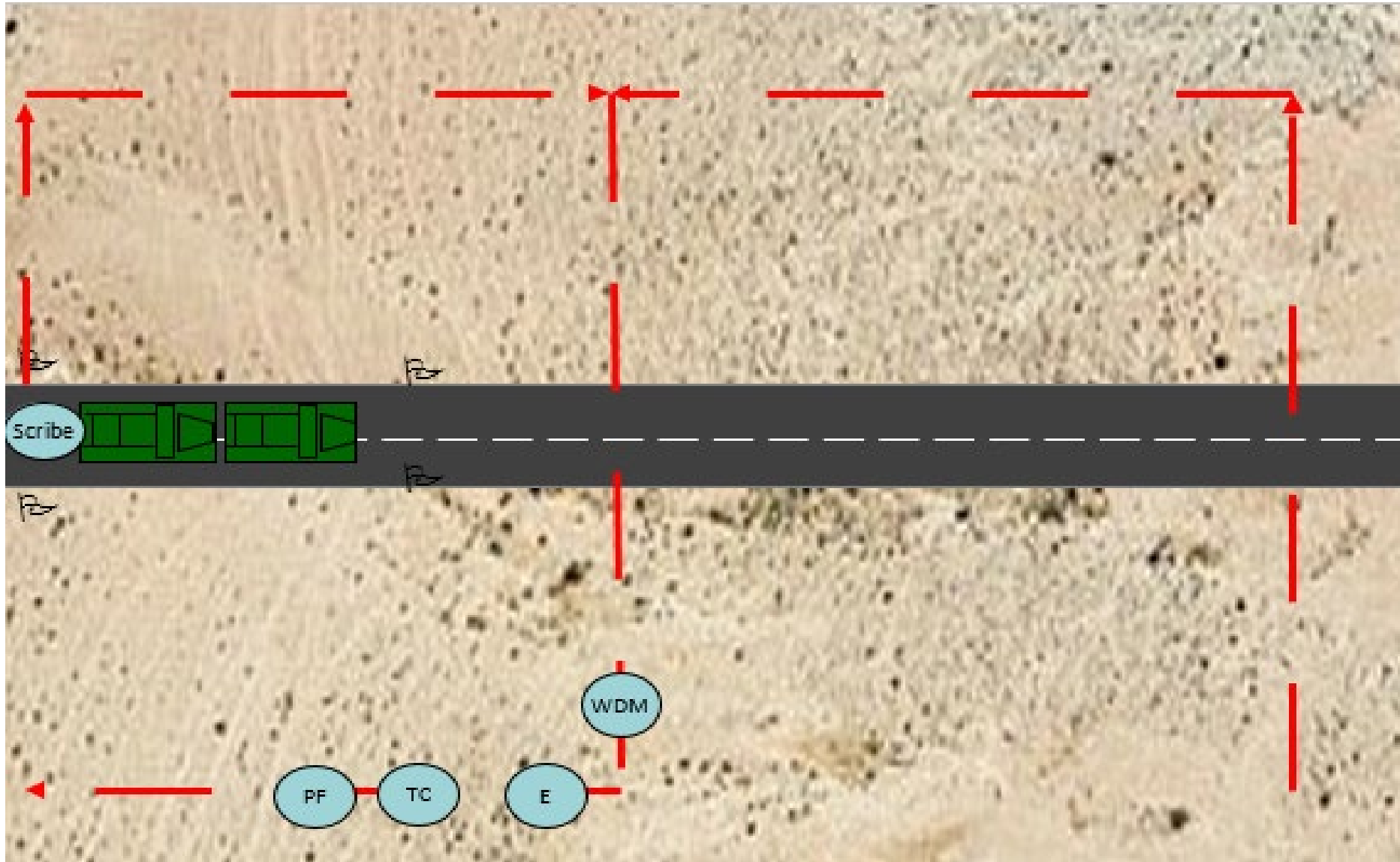



Phases of a Route Search

Isolation Party: Flat Figure of 8

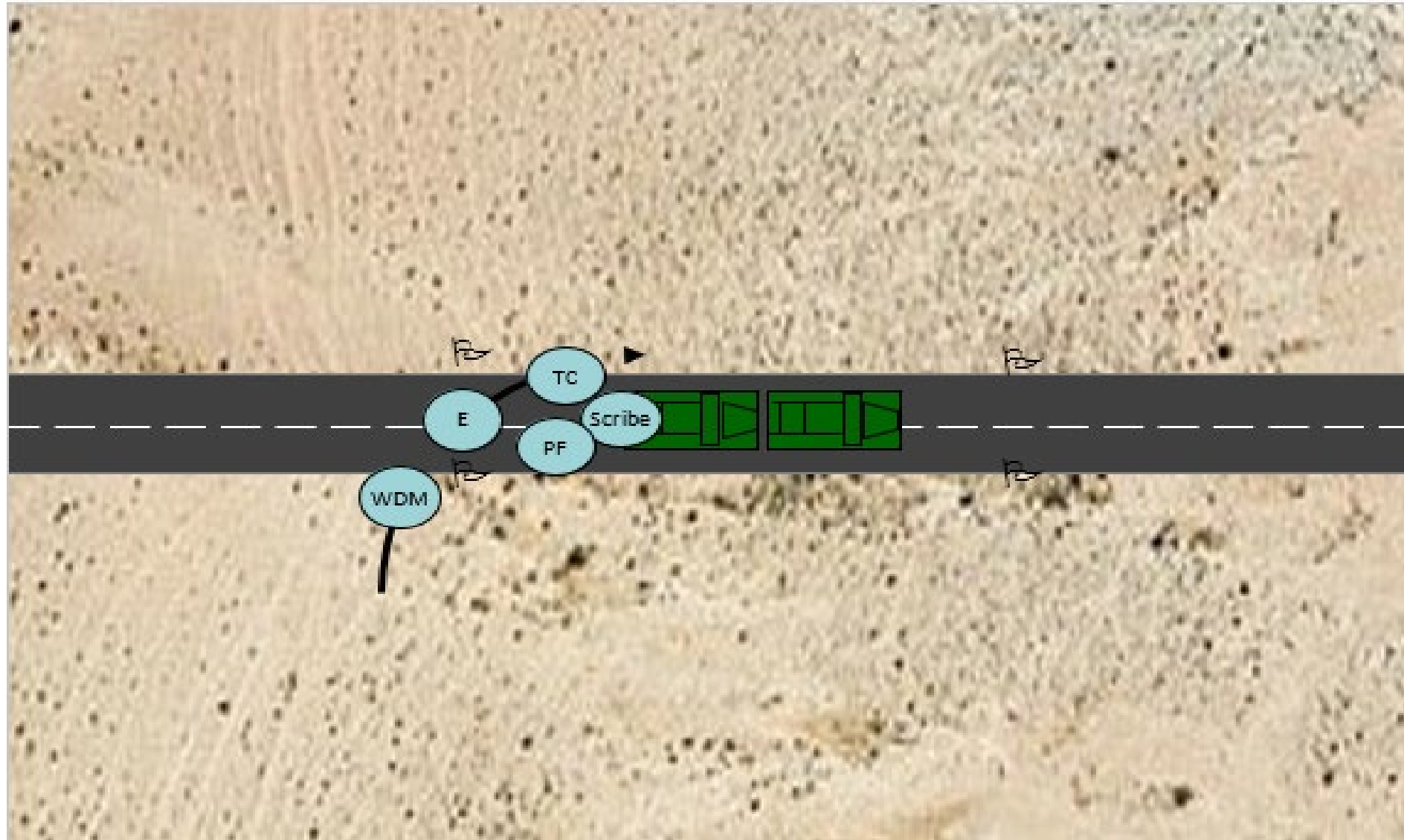



Phases of a Route Search

Isolation Party: Flat Figure of 8

Isolation Party: Conduct a cross over on returning from Isolation

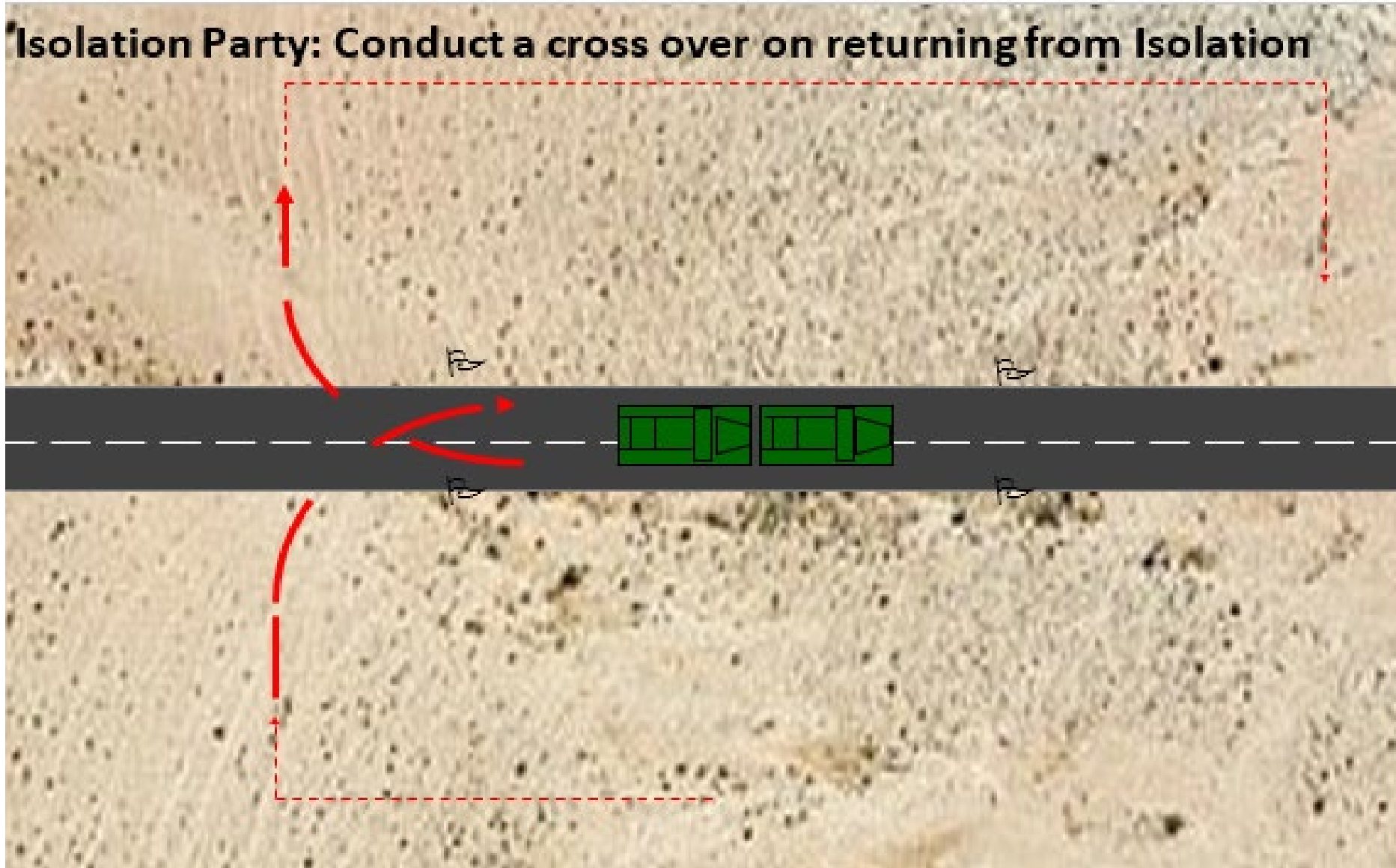



Phases of a Route Search

All subsequent isolations (multiple VPs or Long VAs)

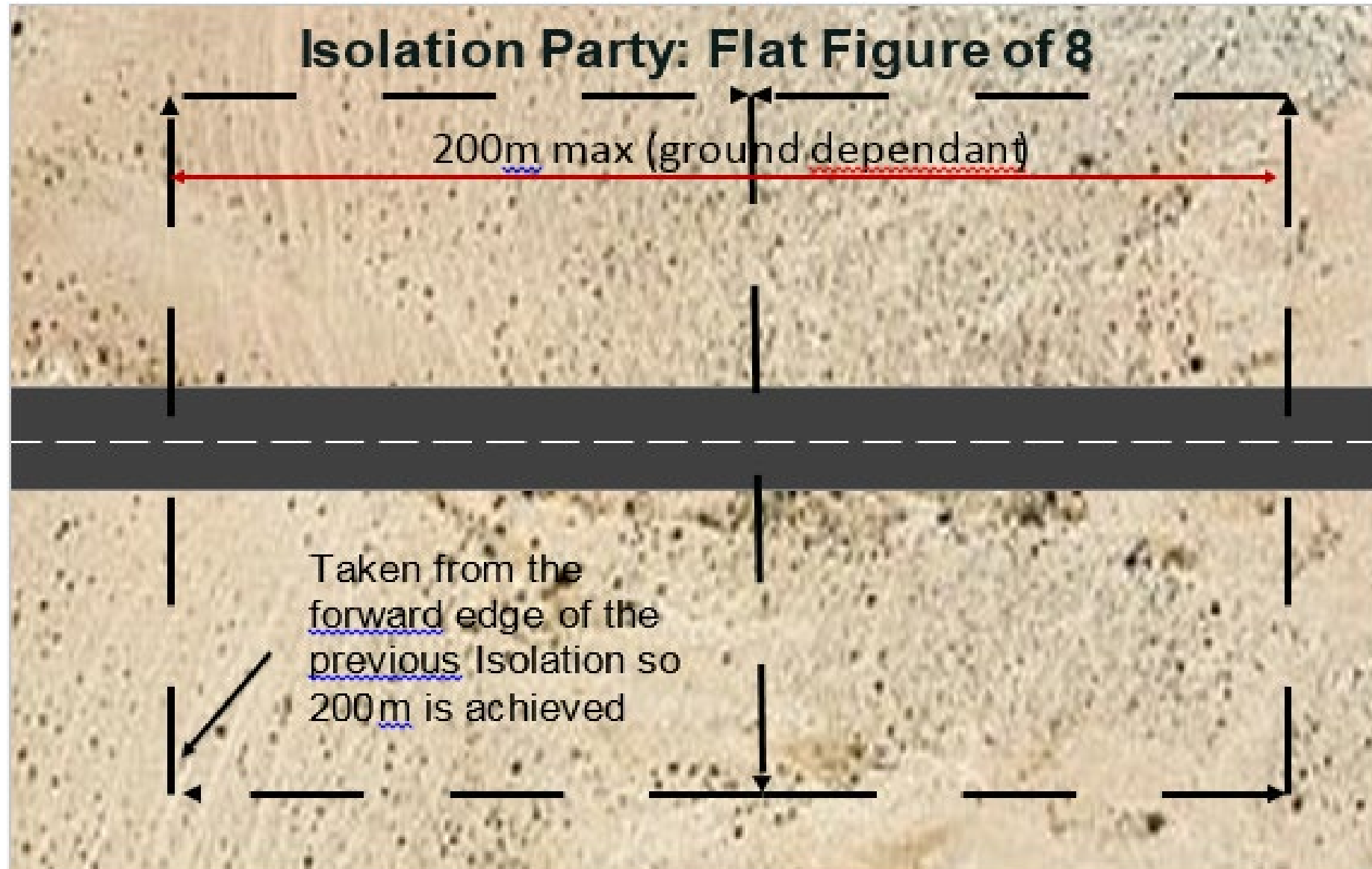



Phases of a Route Search

PAUSE

P – Presence of the abnormal

A – Absence of the normal – if it feels dodgy,
then it probably is

U – Use equipment – can I be targeted?

S – Searchers dictate the pace – avoid setting
patterns

E – ECM Bubble – stay within it



Phases of a Route Search

Phase 5 – Road Party

- To locate roadside IEDs
- Rte Searches are conducted within Isolated Areas
- No member of the Road Party is to move within 20m of an un-isolated area
- ECM if available must be active



Phases of a Route Search

Compacted Earth Road Party



- SA – Search Advisor
- TC – Team Commander
- RM – Road Man
- RSM – Road Side Man
- AES – Ammunition & Explosive Search Dog



Phases of a Route Search

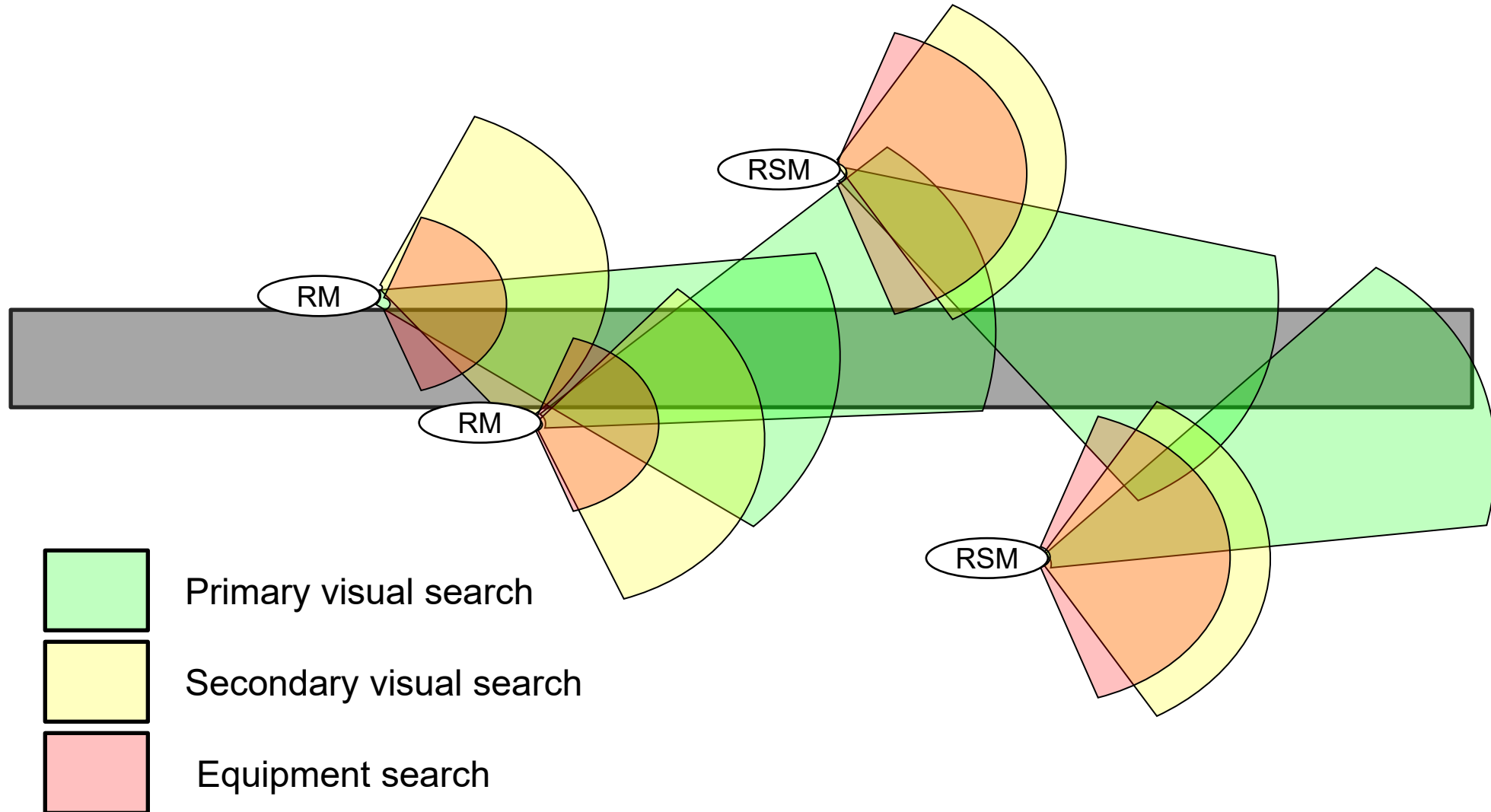



Phases of a Route Search

Road Party - Responsibilities and Equipment

EDD Dog Handler (if available)

- EDD Dog
- Marking system
- ECM if available

Team Commander

- Radio
- Viewing aids
- ECM if available



Phases of a Route Search

Road Party - Responsibilities and Equipment

Road Side Men - Avoid switch?

- Look for GSA, roadside MCs or remoted power sources Equipment
- Metal Detectors (F3 and HOODLUM?)
- Marking system
- Paint brush

Road Men - Search the road looking for switch/IED complete

- Equipment Metal Detectors (F3 and HOODLUM?) - TWF?
- Marking system
- Paint brush



Phases of a Route Search

End of Route Procedure

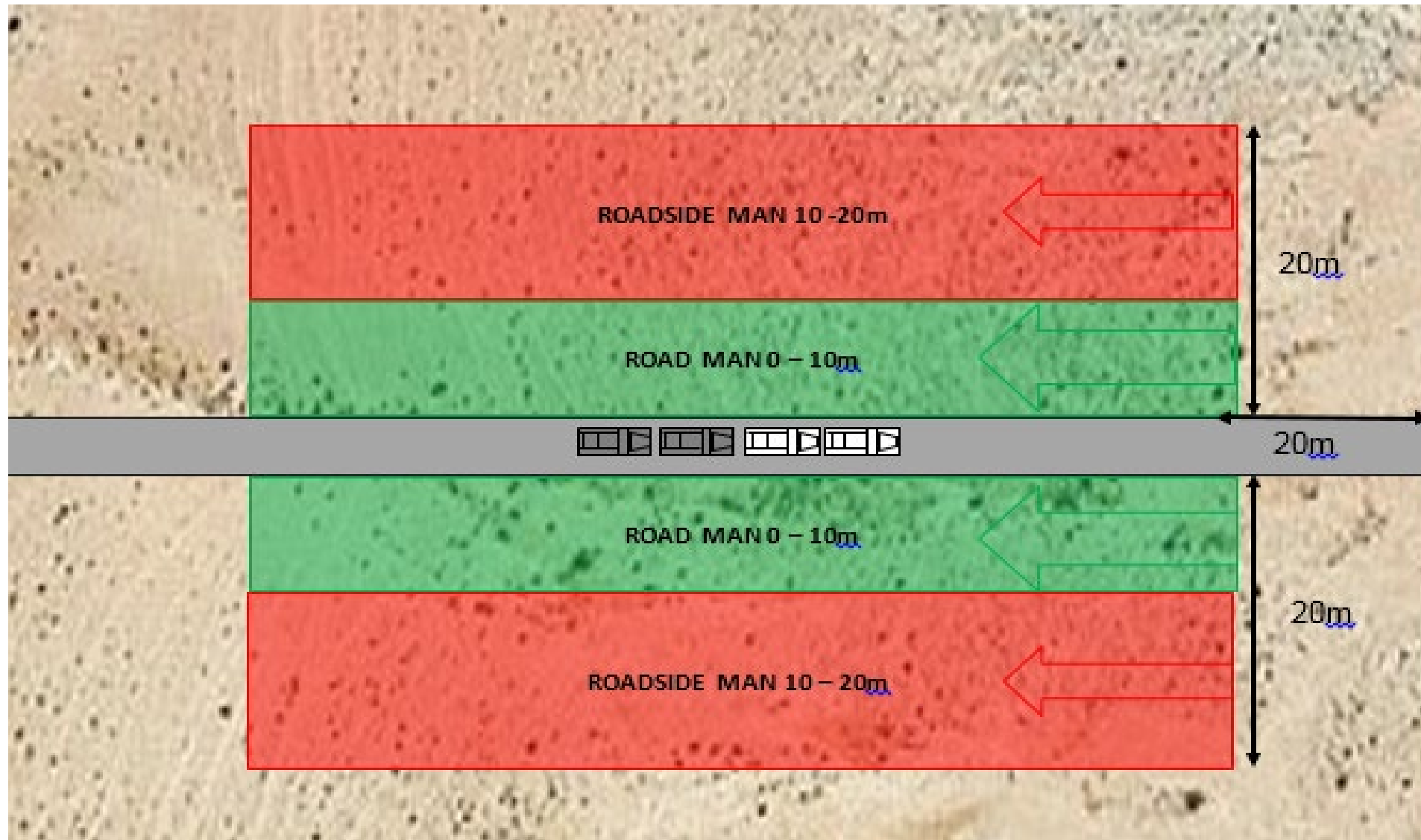



Phases of a Route Search

ANY QUESTIONS?



Actions on CW





Actions On

Actions on CW





Actions On

Actions on:

IED Find

- Stop all searching – mark positions
- Inform SA
- Mark and return to ICP via a safe/searched route
- Brief SA/IEDD

ECM failure (man-portable)

- Stop searching
- Conduct 5 and 25m checks
- If the fault cannot be rectified
 - Return to ICP via a safe route



Actions On

Actions on Find - 5 Cs

- Confirm
- Clear
- Call
- 10 liner
- Cordon
- Control





Restricted Isolations

A restricted Route Search relates to limitations on the route that prevent theatre SOPs from being implemented in full. The restrictions normally affect the Isolation Party and tend to limit physical link detection. Examples include:

- National/State borders.
- Minefields/Obstacle belts.
- Canals or waterways.



Actions On

Restricted Isolations cont.

- Large buildings or obstacles adjacent to the route.

If restricted, the Advisor is to plan the safest course of action whilst maximising opportunities for detection. Consider:-

- Temporarily moving the isolation party outside of the maneuver corridor (stipulated within theatre SOP)
- Use of extra teams
- Use of boats, ladders or assault bridges to aid access



Restricted Isolations cont

- Use of explosive breaching to counter obstacles
- Use of other agencies or host nation forces
- Maximum use of ISTAR and CAS to limit adversary FoM.



Actions On

ANY QUESTIONS?



Sp to EOD/IEDD

- When the location of an IED/Target is known or suspected
- IEDD led operation
- Search assets in support



Support to EOD/IEDD

Support to EOD/IEDD Phases:

- Establish a safe EOD ICP, Operator to choose, 5s/25s Long Isolation (50-75m)
- Short Isolation (50-75m)
- EOD action until target declared explosively safe

Consideration for secondary devices? If there could be another device ... it must be searched!



Support to EOD/IEDD

Support to EOD/IEDD

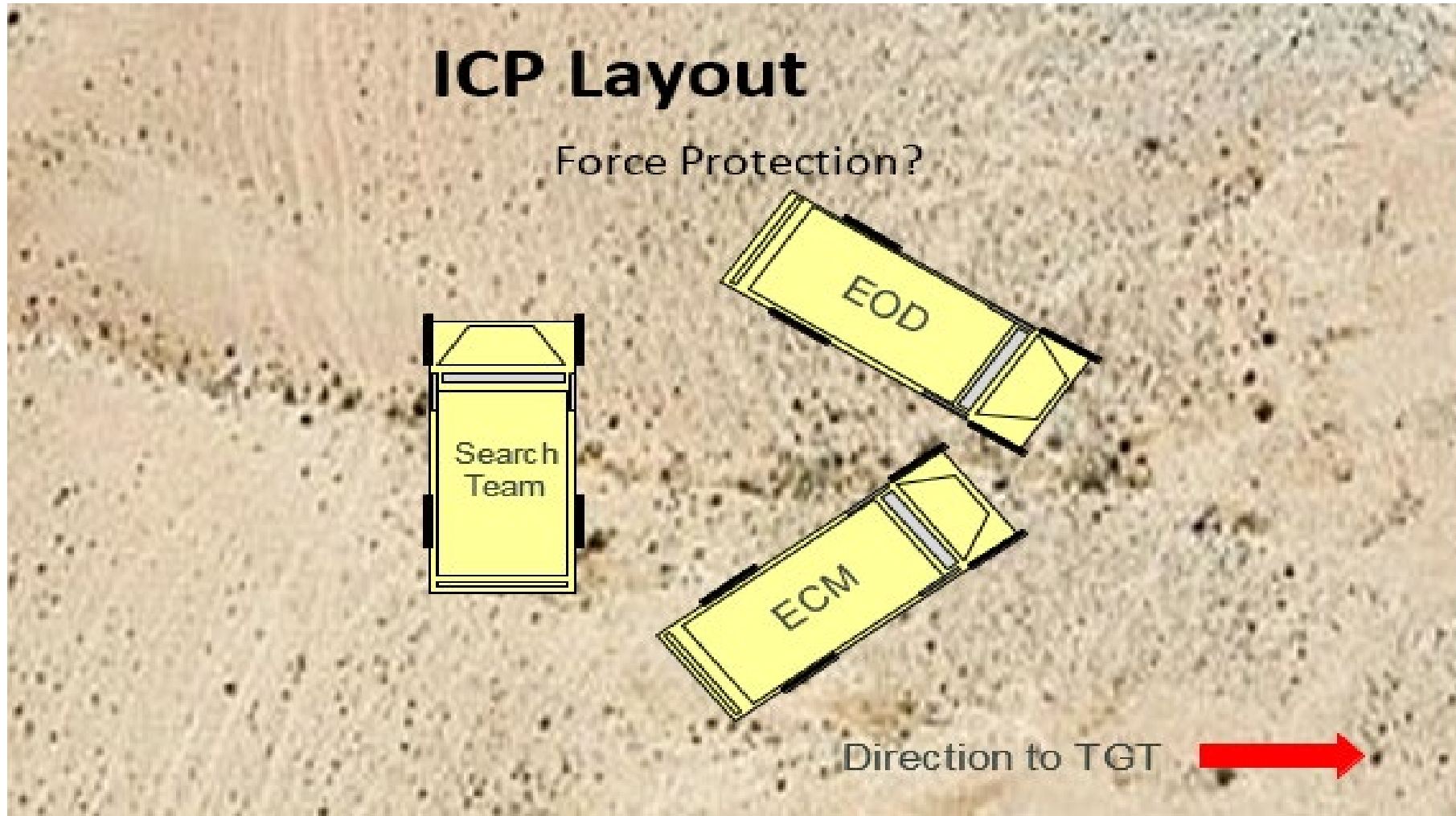



Support to EOD/IEDD

Support to EOD/IEDD

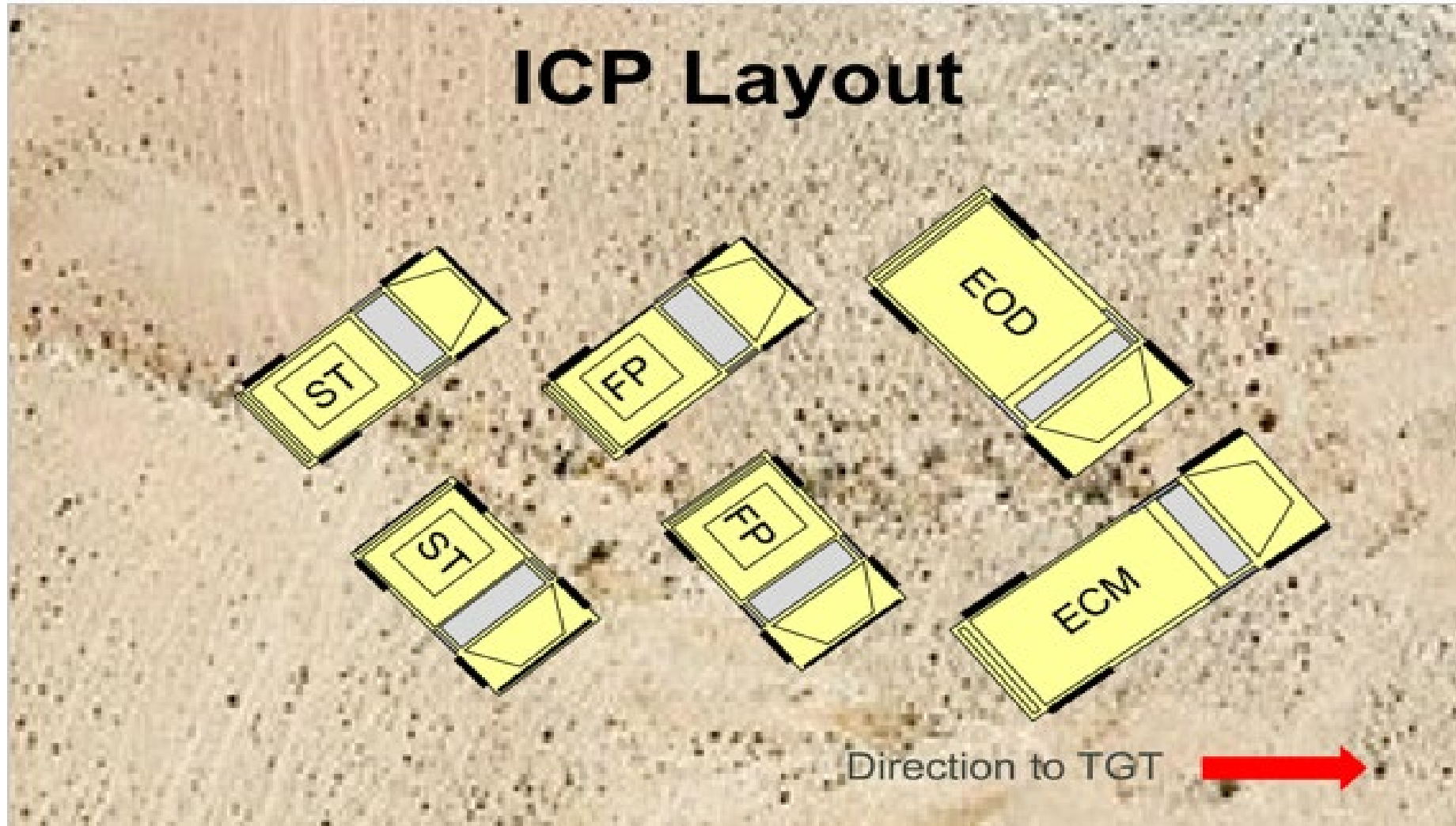



Support to EOD/IEDD - Long Isolation

- 50 to 75m beyond the target
- IEDD Op likely to join the Isolation Party
- Check for CW
- Eyes on target



Support to EOD/IEDD

Support to EOD/IEDD

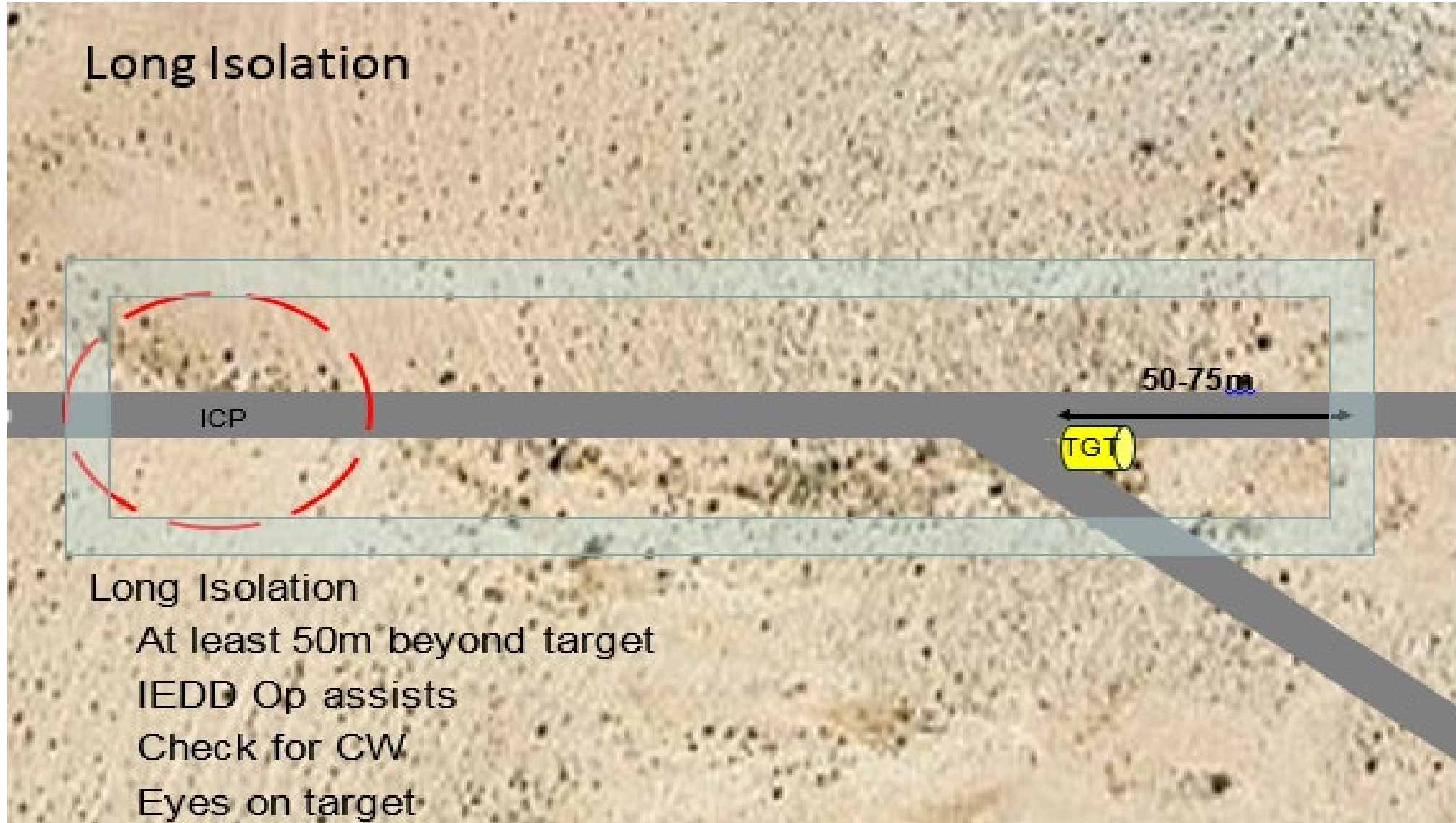



Support to EOD/IEDD

Support to EOD/IEDD

Short Isolation

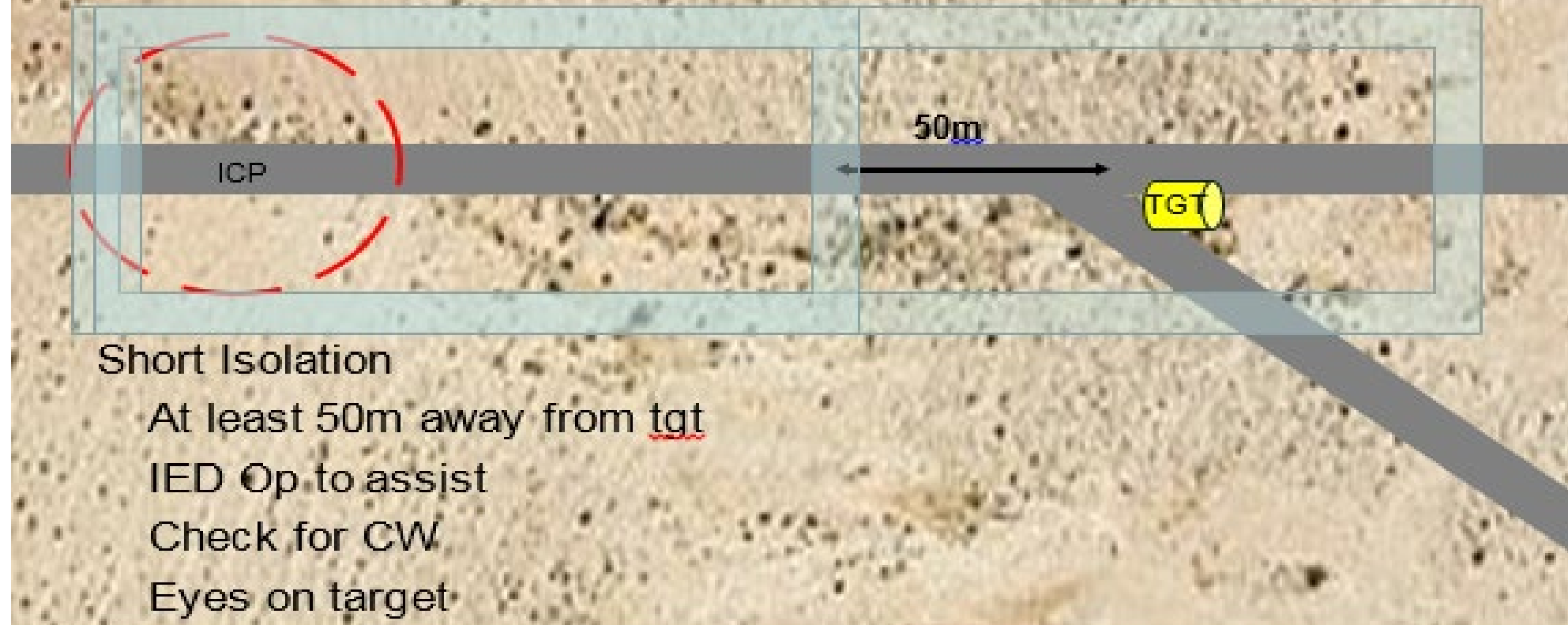



Support to EOD/IEDD – Considerations

- Could there be a secondary threat? If so, what type, where and how many?
- 20m around a target should/could be searched
- Will it be a Road Party or a ‘Search of an Area’?



ANY QUESTIONS?



Summary

You should now have an understanding of how a route search is carried out. This is the most important component of the All-Arms Search Course. This skill is a proven life-saving technique and is invaluable in the fight against the IED.



Exercise

The Instructors will now take you through a practical demonstration of a route search before you will be given the opportunity, under the guidance of an instructor, to practice each phase in detail.



Look forward to...

MODULE 2.5 – AREA SEARCH



All Arms Search Course (AASC)

Module 2.5

Introduction to Area Search



Range

- Time
- Safety
- Questions
- Notes
- Phones/Devices
- Food/Drink
- Previous knowledge
- Assessment



Module Objective

At the end of this module, participants will be able to effectively identify reference points and conduct an area search.



Teaching Points Covered

- Identify the 3 types of cache/hides
- Characteristics and threats associated with a cache/hide
- Identifying reference points
- 6 phases to an Area Search



Area Search

- Area Search is principally an offensive operation and is used to locate adversary resources secreted in hide locations. It uses the principle that an adversary follows identifiable criteria when attempting to conceal resources.
- Identification of these criteria allows for a better-prioritised Search effort and thus enhanced productivity. This pattern analysis, known as the 'Winthrop Theory', enables Searchers to identify the most likely areas to contain a hide.
- Lower Risk of IED



Area Search Intro





Reference Point





Area Search Intro





Area Search Intro





Types of Terrorist Hide

Long term





Types of Terrorist Hide Cntd...

Transit





Types of Terrorist Hide Cntd...

Short term





The Transition through Hides



Long Term



Short Term



Transit





Hide Characteristics

Available for immediate use





Hide Characteristics Cntd...

Accessible & Concealed





Hide Characteristics Cntd...

Non attributable





Hide Requirements Cntd...

Locatable by day and by night





Reference Points

Reference Points

Primary - the obvious marker that really stands out in the area

Secondary - a marker which is less obvious but can be easily found from the primary marker





Reference points Requirements

Permanent





Reference points Requirements

Prominent





Reference points Requirements

Not too artificial





Identify Reference points





Identify Reference points Cntd...





Identify Reference points Cntd...





Information sources

- Mapping
- Photocopy
- Recce
- Reports



Area Search planning

1. Threat
2. Methods of Insertion/extraction
3. GR and radius of target area
4. Pattern of life
5. Time available
6. Number of teams
7. Other agencies
8. Tactical situation
9. Boundaries
10. Known or suspected enemy



ANY QUESTIONS?



The 6 Phases of an Area Search

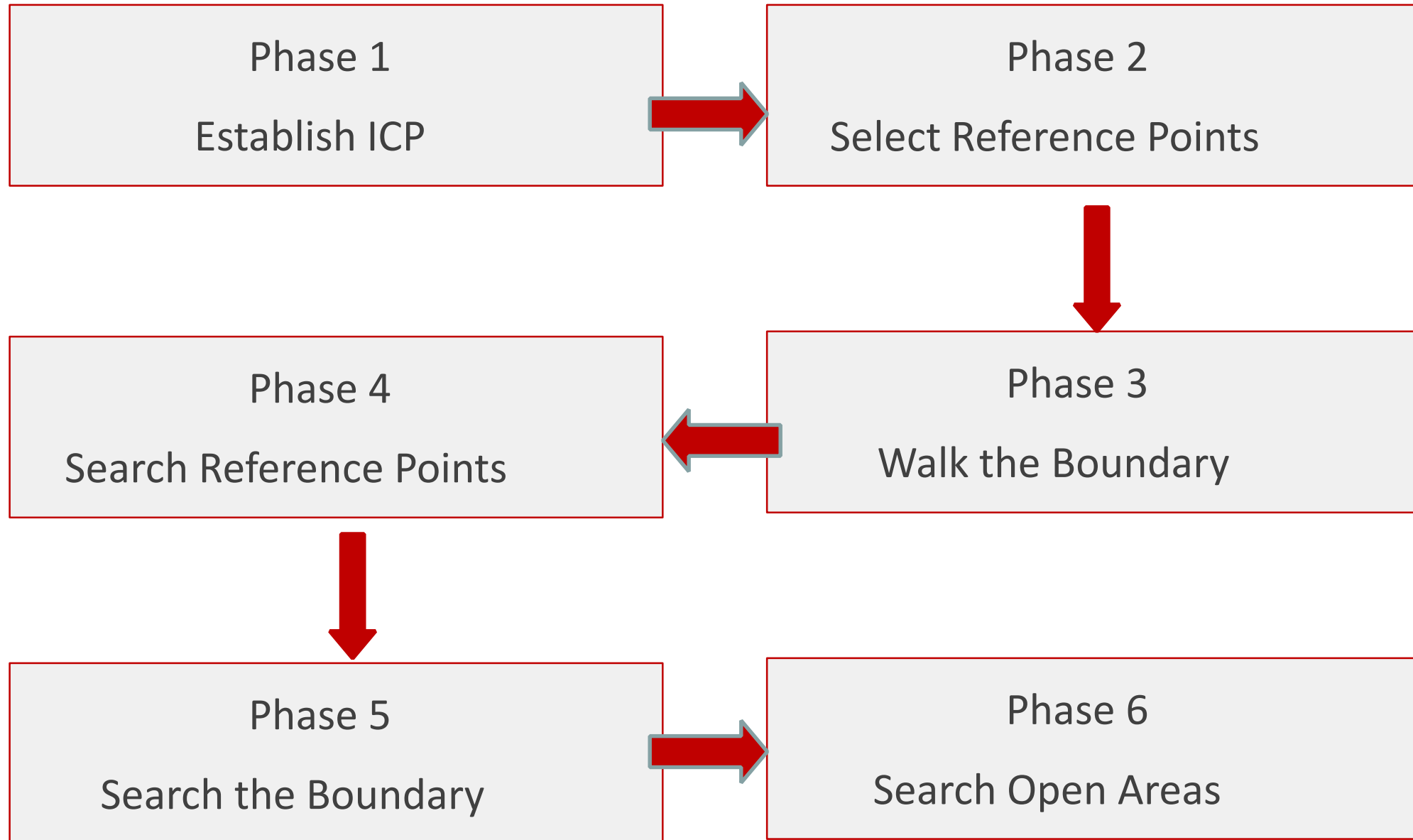



The 6 Phases of an Area Search

Phase 1

Establish ICP



The 6 Phases of an Area Search





The 6 Phases of an Area Search



Establish ICP
Pre selected.
Tactically sited.
Searched prior to occupation.



The 6 Phases of an Area Search

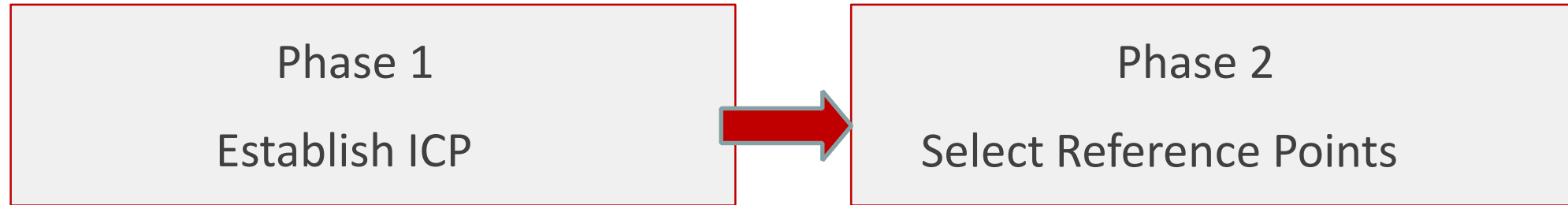



The 6 Phases of an Area Search





The 6 Phases of an Area Search

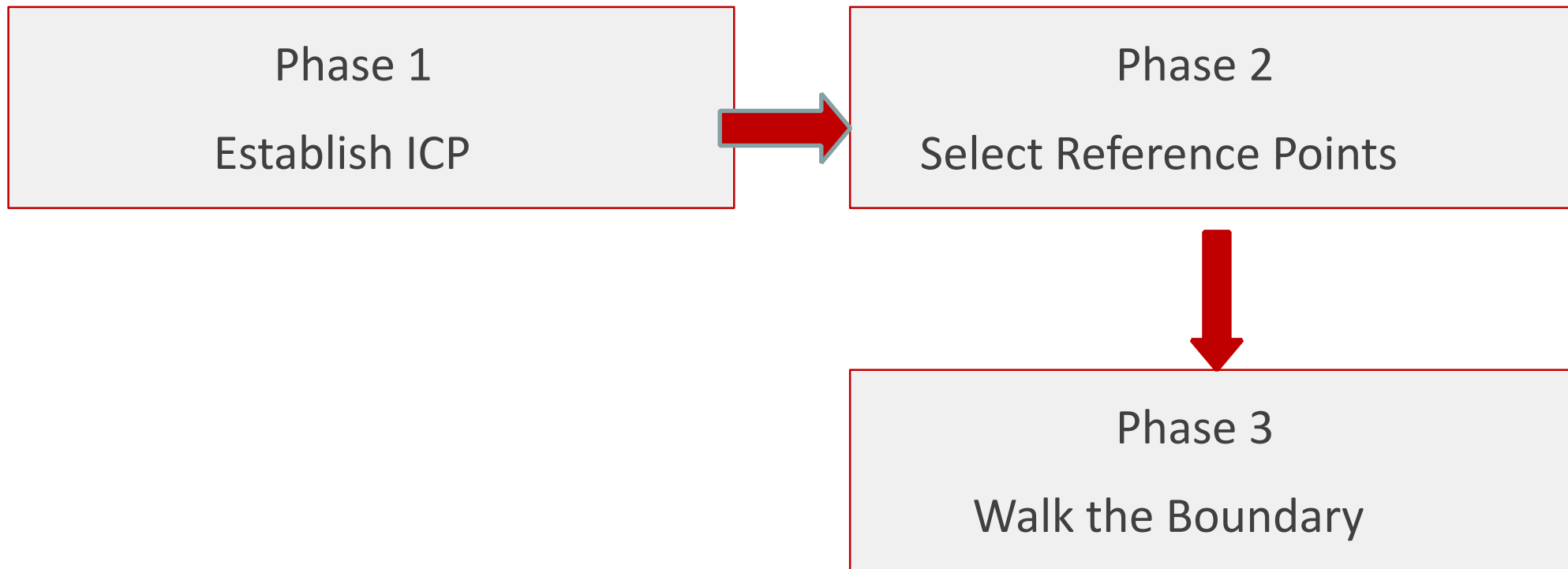



The 6 Phases of an Area Search

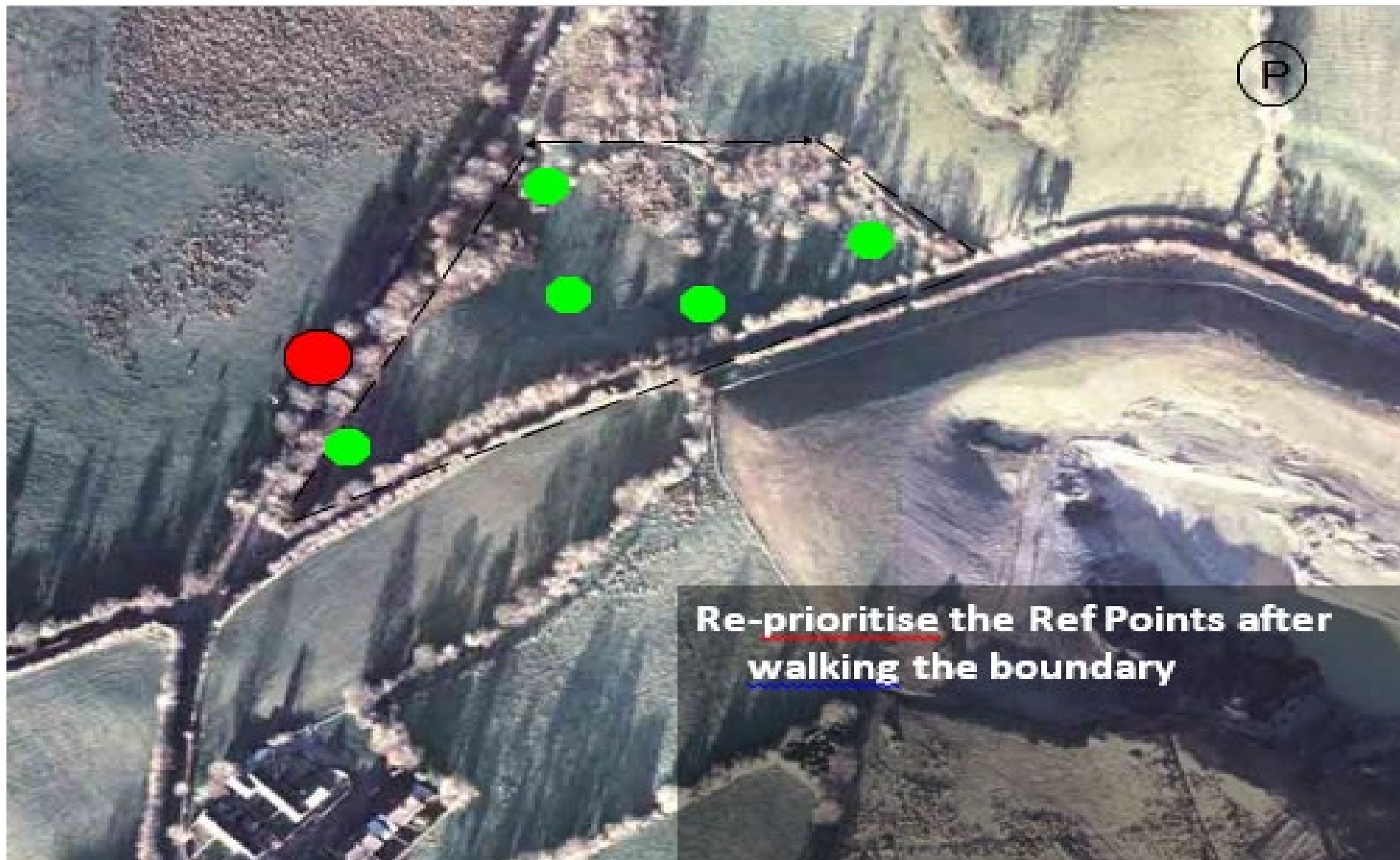

Re-prioritise the Ref Points after
walking the boundary



The 6 Phases of an Area Search

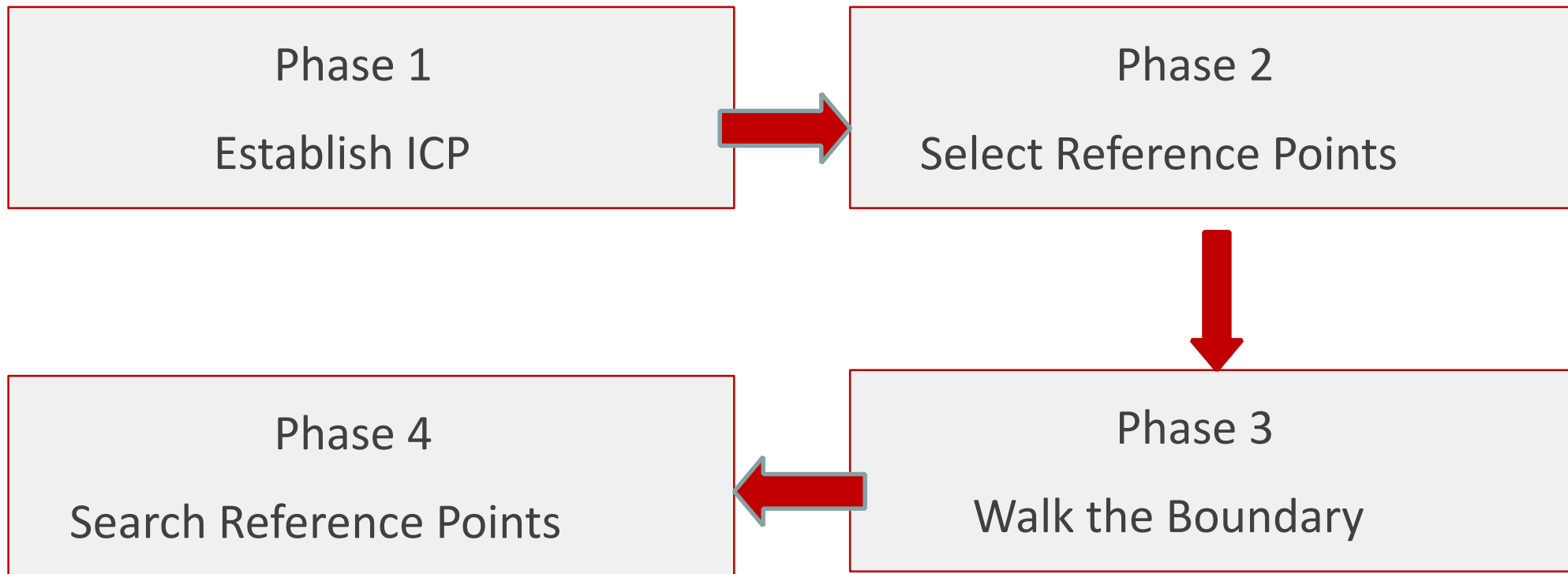



The 6 Phases of an Area Search





The 6 Phases of an Area Search

5m – 15m Equip & Visual

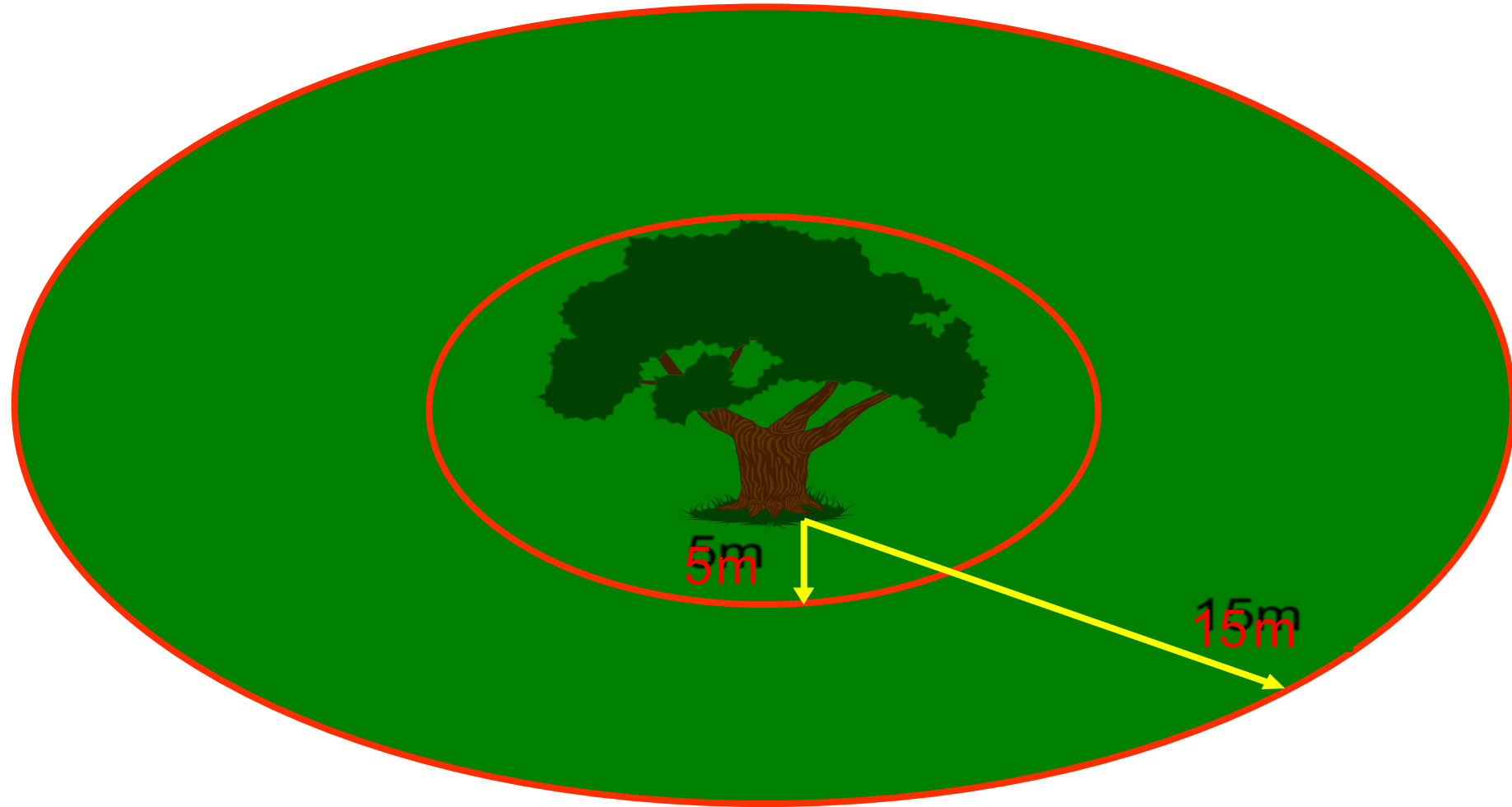



The 6 Phases of an Area Search

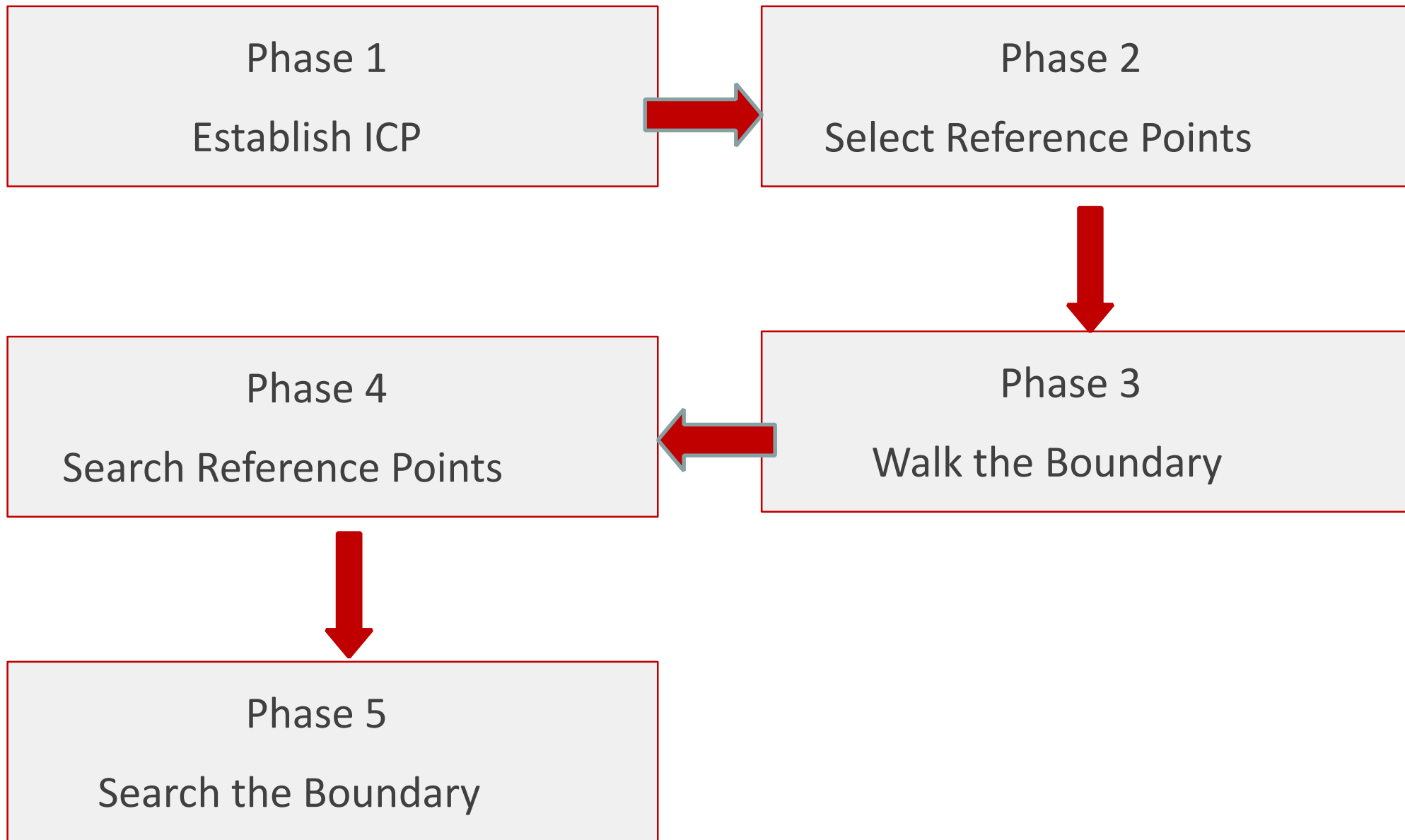



The 6 Phases of an Area Search

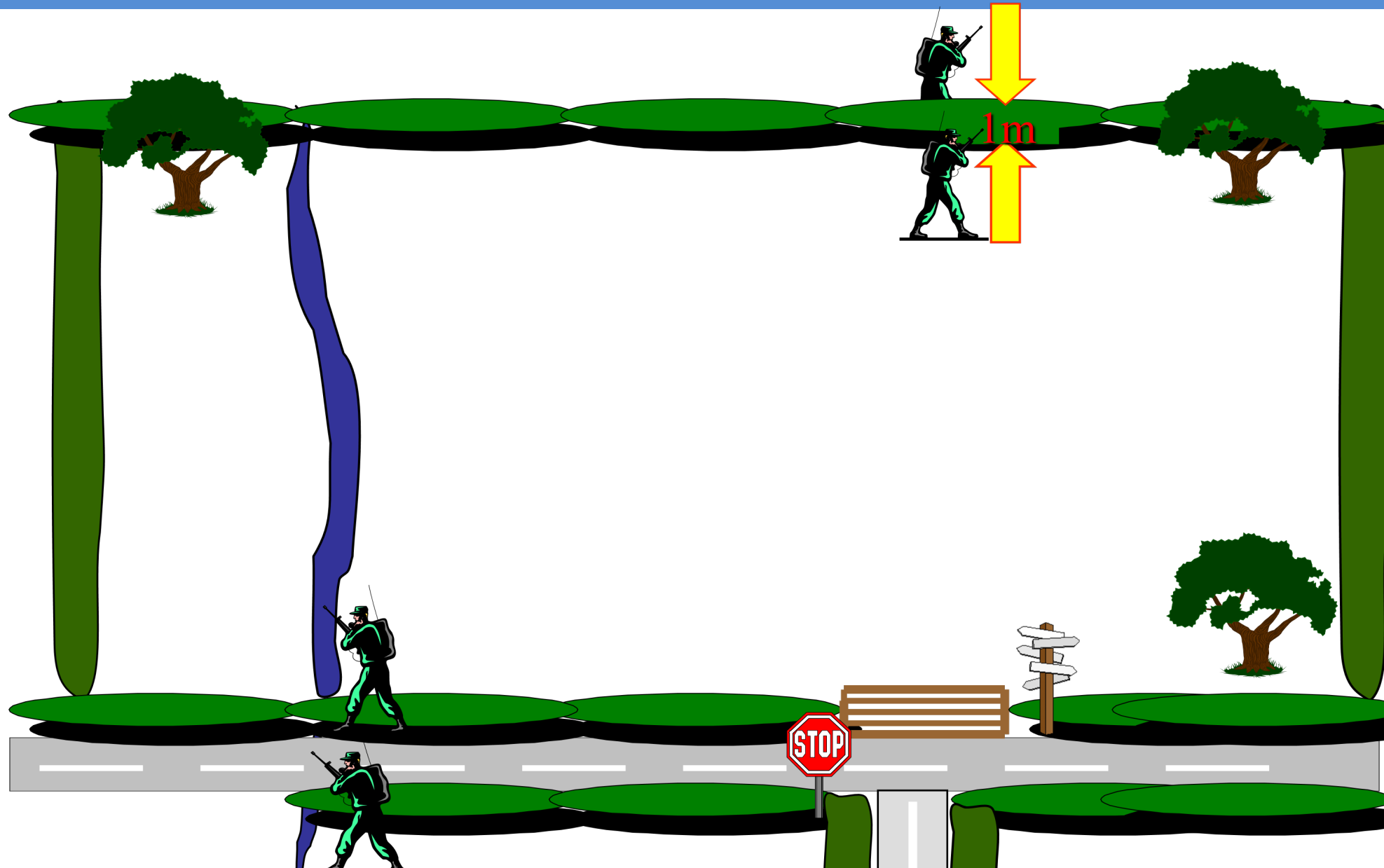



The 6 Phases of an Area Search

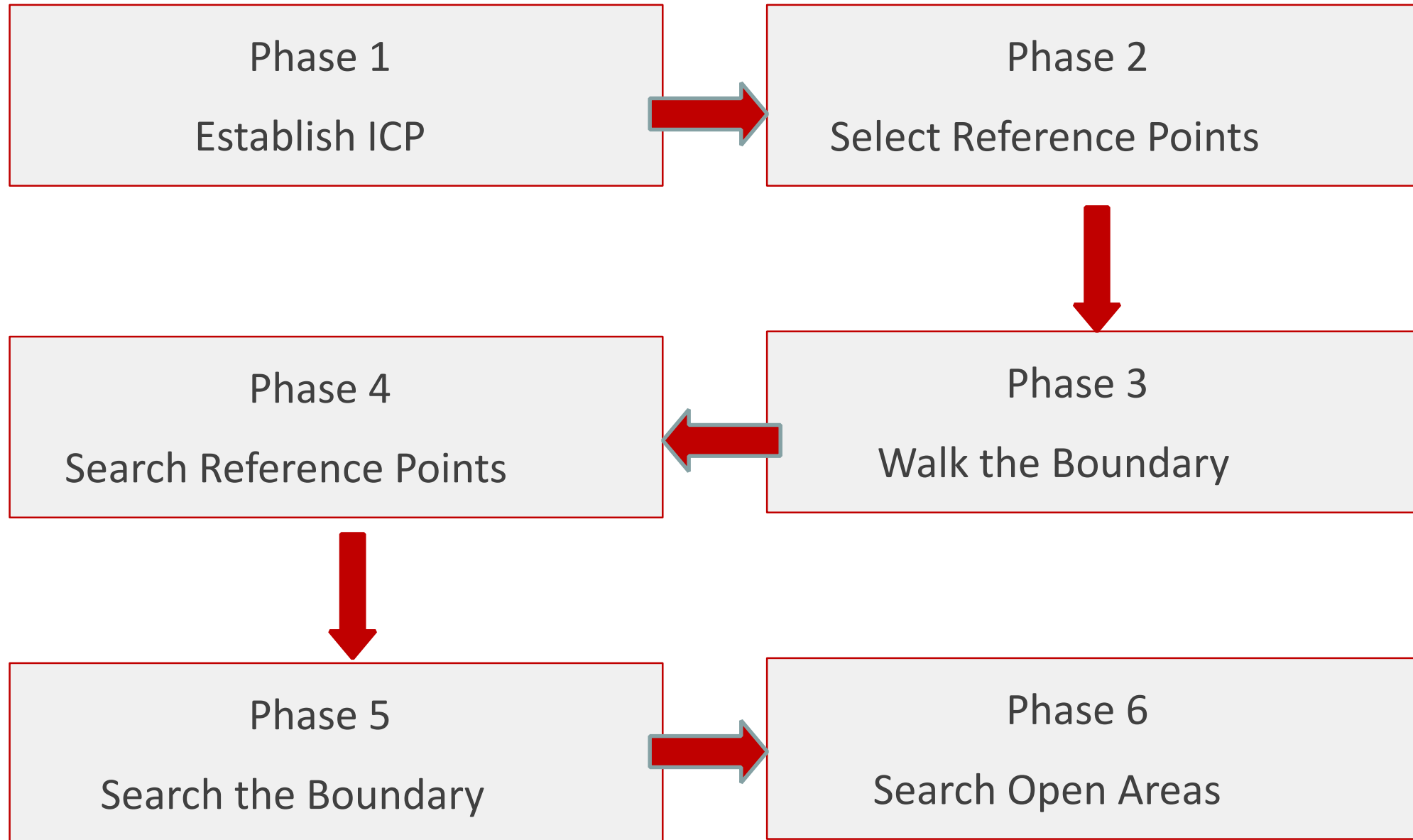



Considerations

- Hoodlum
- Binoculars
- Prodders
- Digging tool
- Pin markers
- Notebook and pen



Considerations

Life-Threatening – 5Cs:

Confirm - Only as much as is absolutely necessary.

Life-Threatening – 5Cs:

- Confirm
- Clear
- Call
- Cordon
- Control



Considerations

Non-Life-Threatening:

Confirm - Only as much as is absolutely necessary.

Non-Life-Threatening:

- Confirm
- Conceal – option?
- Continue
- Report to Comd

Exploit – Depending upon agency availability



Non Explosive/Firearms find

Inform team commander

React as directed in theatre SOPs



ANY QUESTIONS?



Questions

1. What are the 6 phases of Area search?
2. What are the 3 types of hides?



Summary

Although Area Search is the least dangerous of the searches, the searchers should be prepared to deal with any potential threats correctly. All Area searches should be carried out in the manner explained previously, this will ensure that not only are the searchers as safe as possible, but it will also ensure that the area is searched fully and any evidence that is found can be dealt with correctly, in order to conduct further operations or prosecutions.



Look forward to...

**MODULE 2.6 –
Introduction to
COMPOUND SEARCH**



All Arms Search Course (AASC)

Module 2.6

Introduction to Compound Search



Range

- Time
- Safety
- Questions
- Notes
- Phones/Devices
- Food/Drink
- Previous knowledge
- Assessment



Module Objective

At the end of this module, participants will be able to identify threats and effectively conduct a compound search.



Teaching Points Covered

- 3 levels of compound search
- Threats within a compound
- Vulnerable points
- Planning considerations
- Phases of compound search



DEFINITION OF A COMPOUND

A compound is an enclosed area of land that is used for a particular purpose.



Vulnerable Areas Within a Compound

Most likely position for an IED or booby trap

- Likely FPs
- Entry points
- Channeling points
- Wells
- Voids in buildings



Three Levels Of Compound Search

- **Basic**
 - No specific Threat
 - No Intelligence
- **Intermediate**
 - Low Threat
 - No specific Intelligence
- **Advanced**
 - High risk of an IED being present
 - high level of assurance is required
 - A Hazardous environment exists
 - Specialist eqpt is required





The Threat in Compounds



- Building occupants
- Shoot
- Public disorder
- Resource protection





Compound Search Planning Cntd...

- Number of teams
- Other agencies
- Tactical situation
- Entry location
- Protection
- Females and children



Vulnerable Points

The place or places where EF are most likely to position a device or booby trap:

- Entry points
- Likely FP positions
- Channelling points
- Voids in buildings





Planning considerations

- Avoid the compound – Is it mission critical
- GR and size of target area
- Pattern of life
- Time available
- Number of teams
- Other agencies
- Tactical situation
- Entry location
- Protection
- Females and children



Information Sources

Information sources:

- Mapping
- Photography
- Recce
- Reports
- Local knowledge
- G2 previous attacks





ANY QUESTIONS?



5 Phases to Compound Search

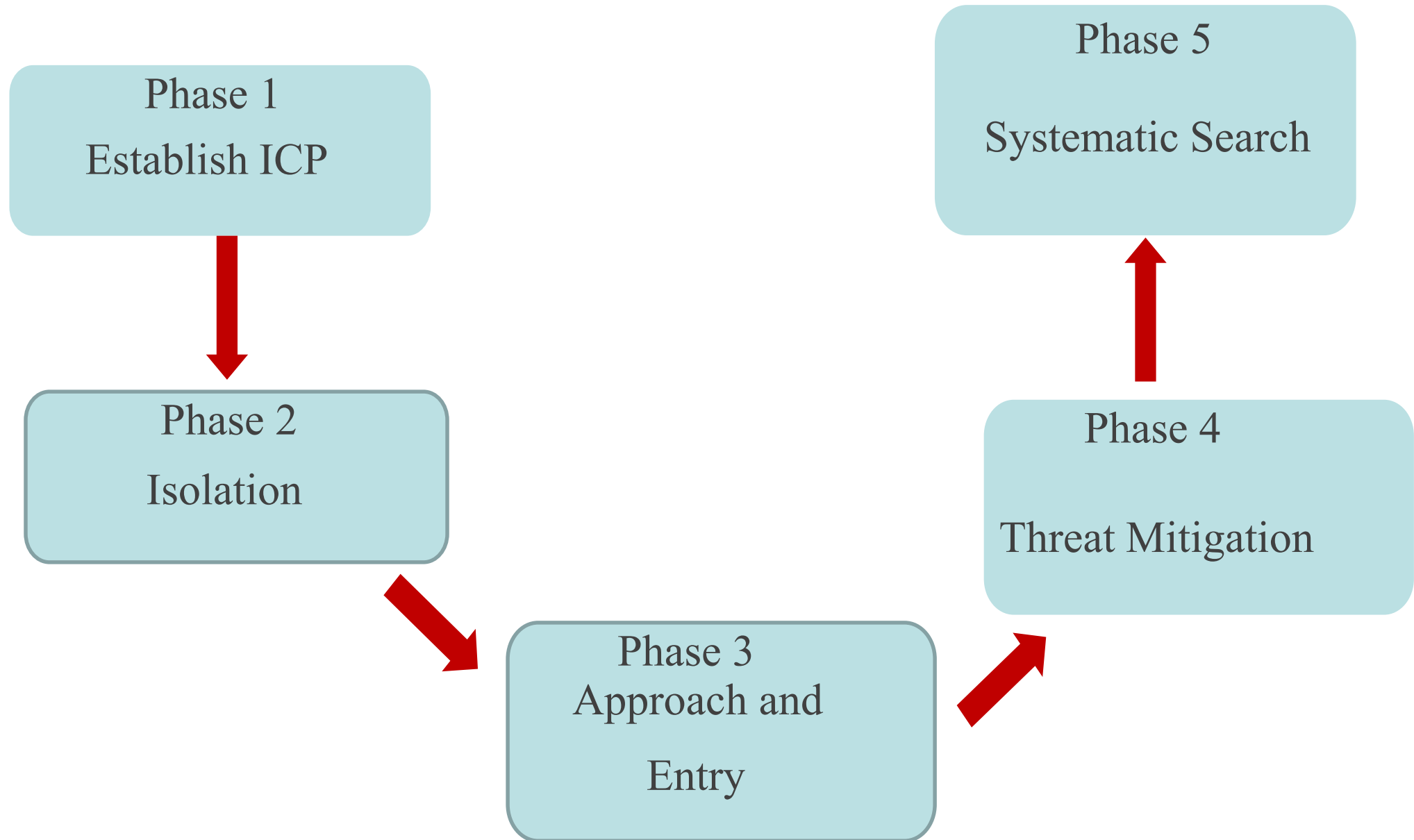



5 Phases to Compound Search

Phase 1

Establish ICP



5 Phases to Compound Search

Establish ICP

5m & 25m checks

- ICP 100m
- Dominate ground
- Cordon

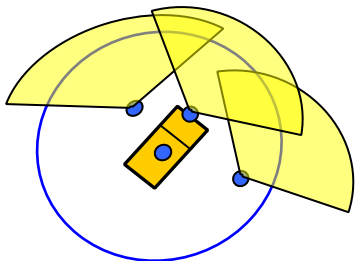
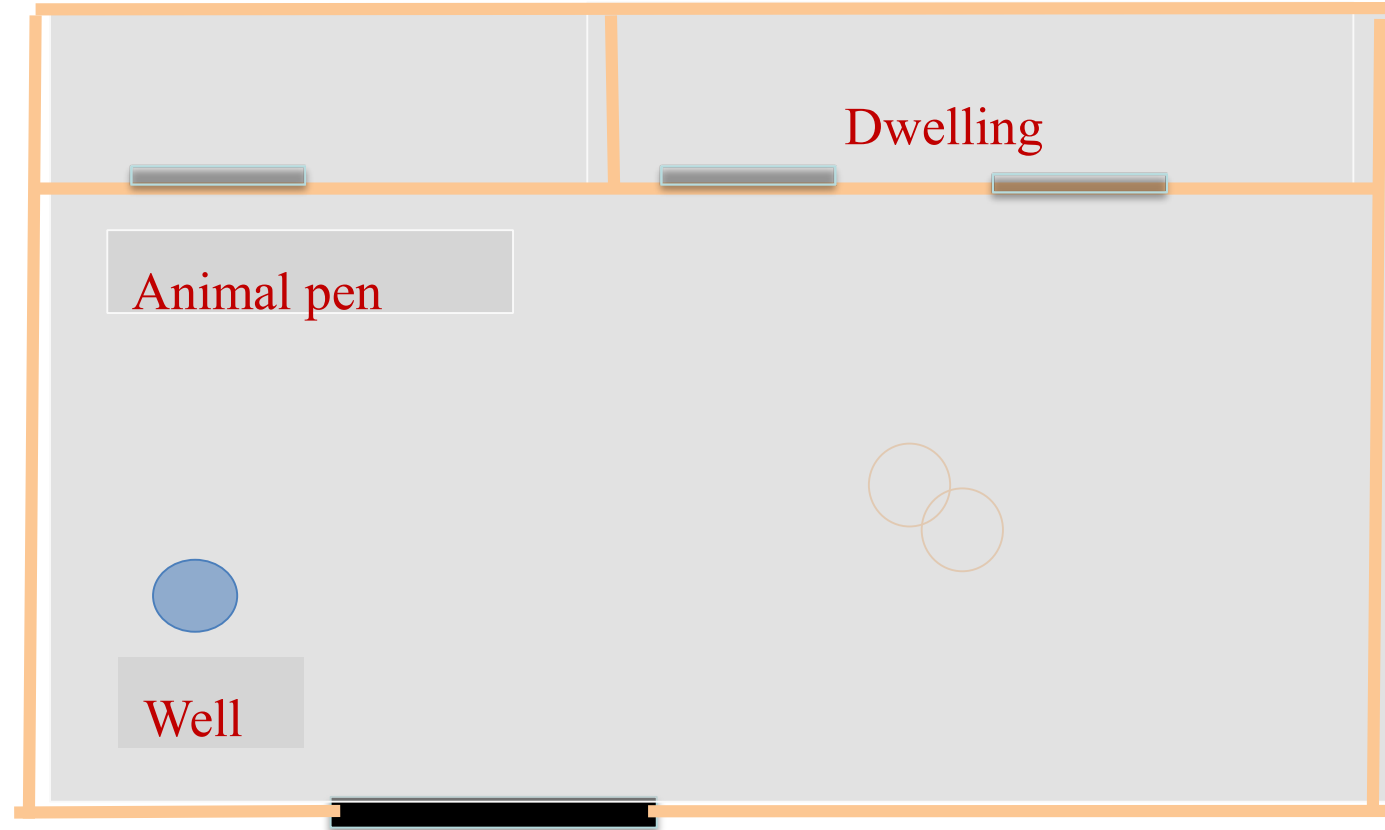



5 Phases to Compound Search

Phase 1
Establish ICP



Phase 2
Isolation



5 Phases to Compound Search

- Establish ICP
- Isolation flat

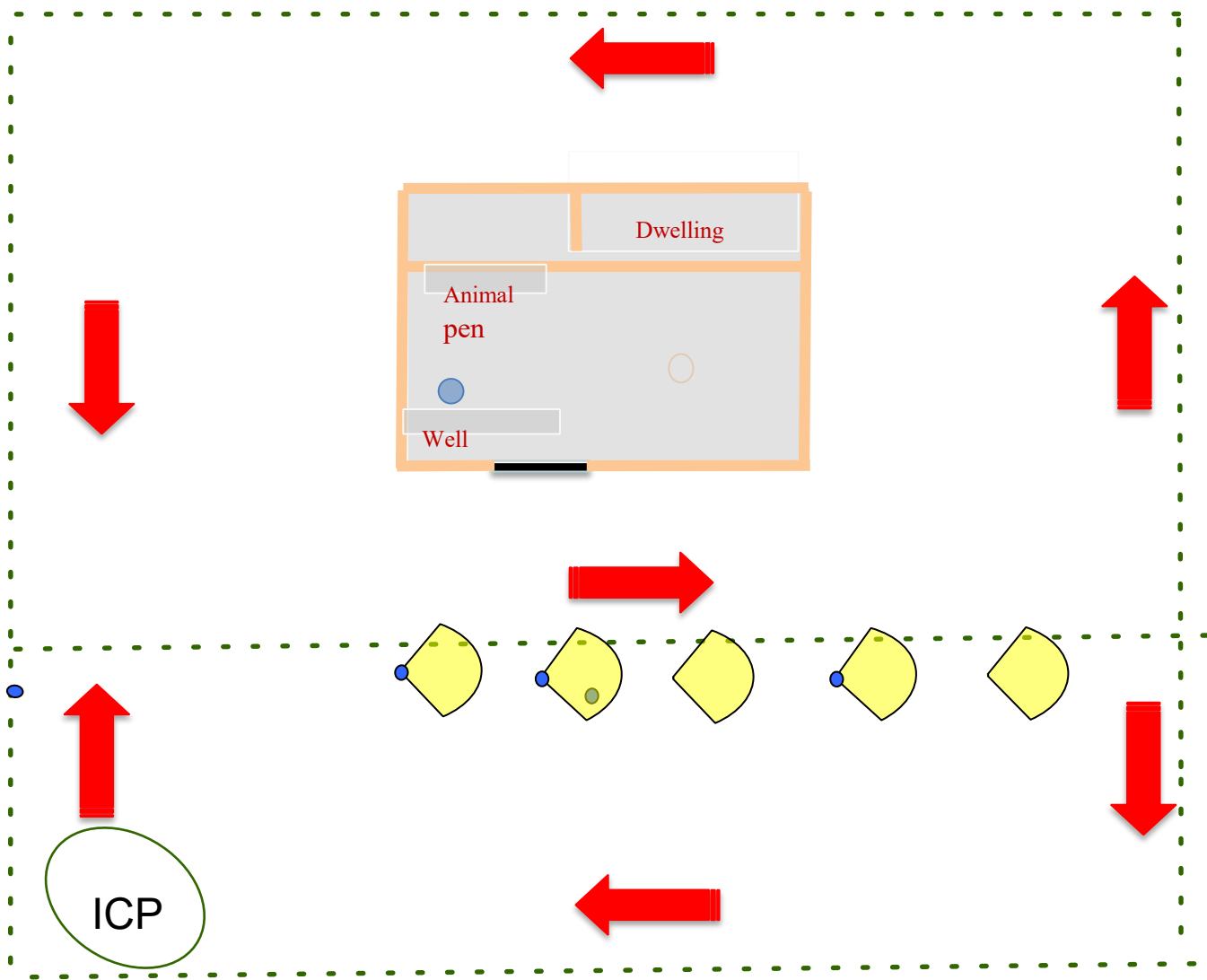



5 Phases to Compound Search

Isolation Party

Dependent on ECM capability

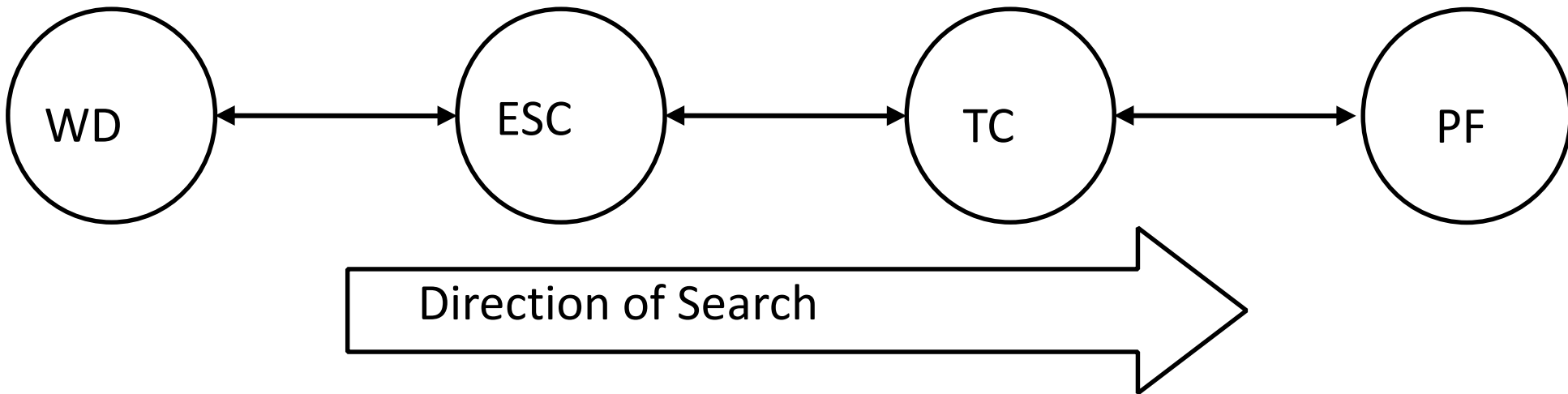



ANY QUESTIONS?



5 Phases to Compound Search

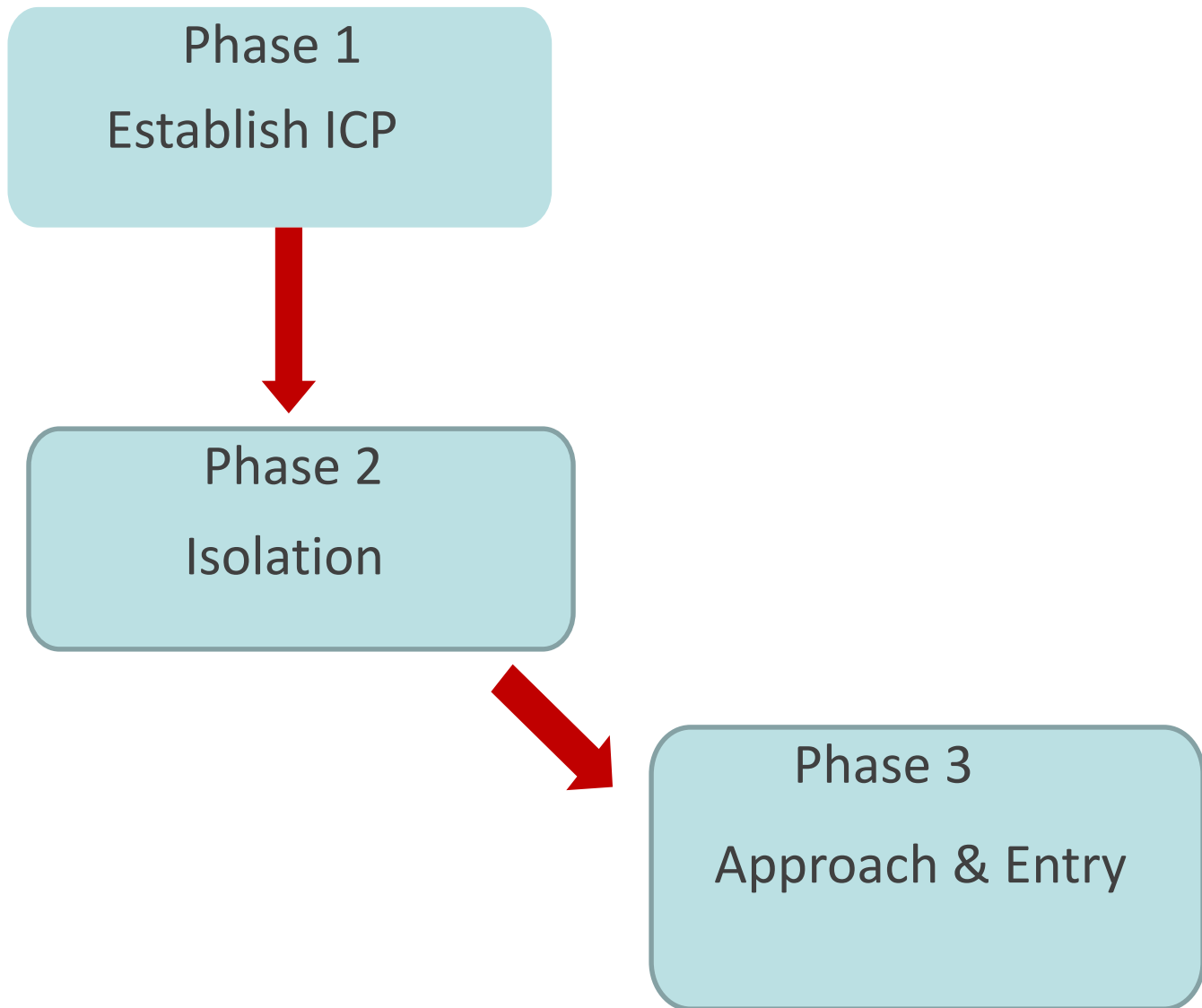



5 Phases to Compound Search

Approach

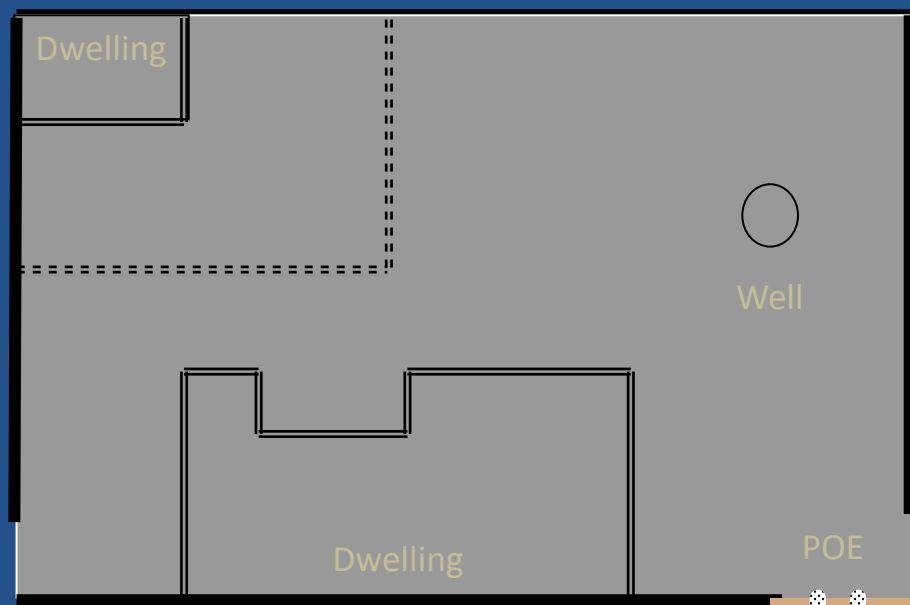

- 5m bounds
- 3D search



5 Phases to Compound Search

Entry

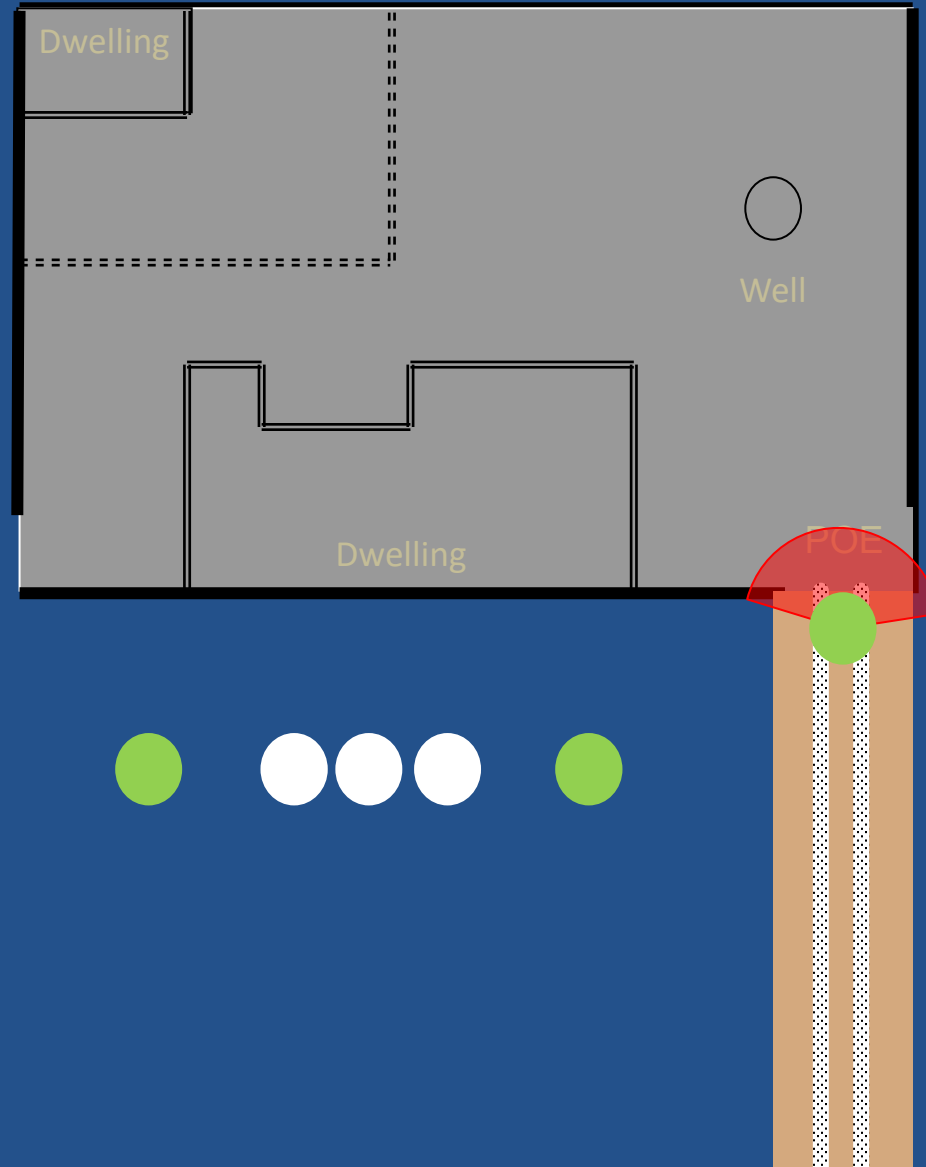

- Visual search
- TWF
- 3D sweep
- Finger tip search



5 Phases to Compound Search

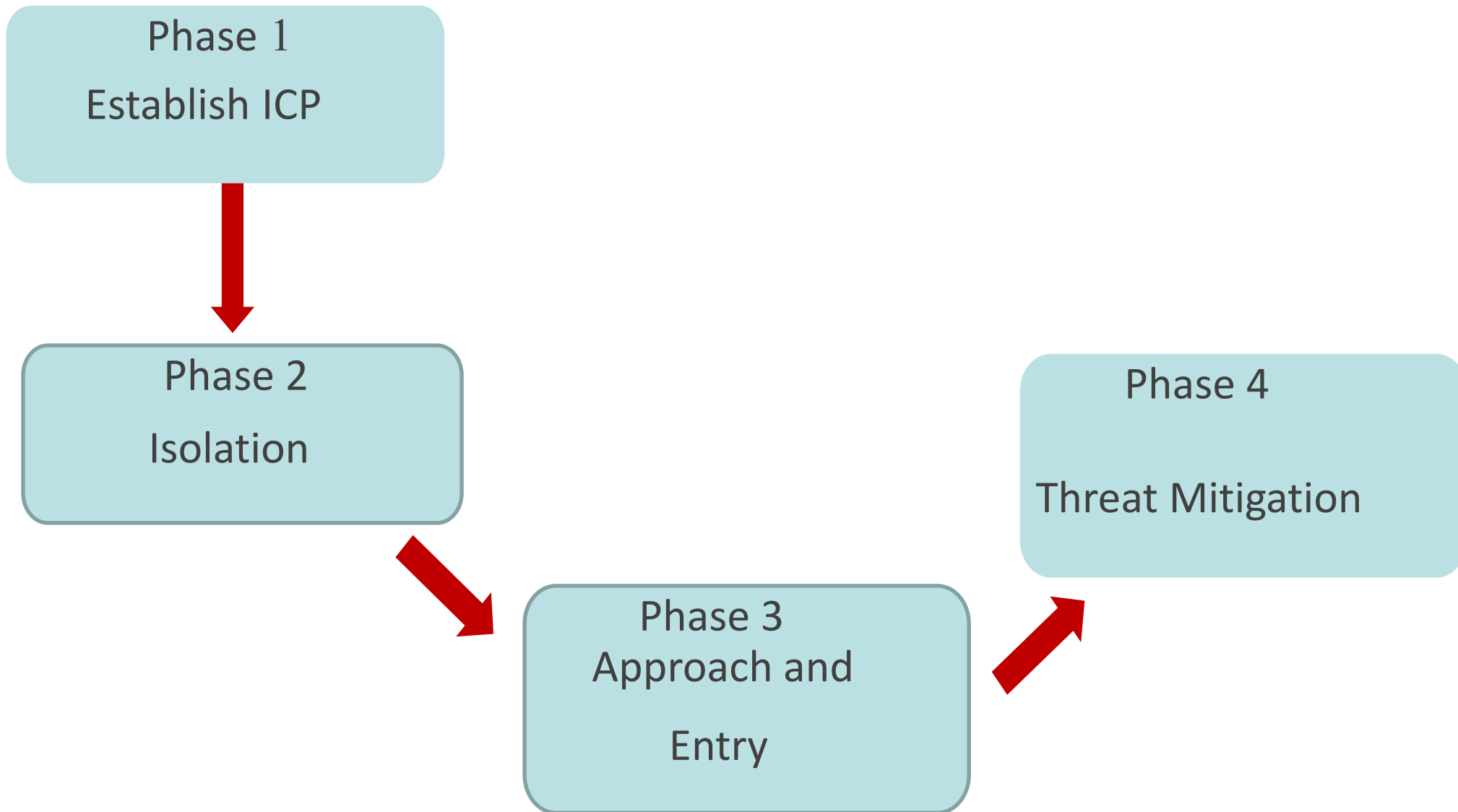



Think Threat Mitigation

- Single lane?
- 2-man wide lane?
- Road Party?
- Free to walk up to a Working Box?
- 100% Searched up to the POE?
- Dog used?
- ECM Req'd?



5 Phases to Compound Search

- Open areas should be Searched with an appropriate detector or dog commensurate with the Advisor's TA.

(“Search of an Area” and not an Area Search!!!)

- Dependent on the TA moveable items can be moved by remote or semi-remote means.
- Moving multiple items in one pull will reduce the number of soak periods and overall task time.



5 Phases to Compound Search

- All doors/windows should be moved, either remotely or semi remotely to their full range, and wedged open once confirmed.
- Searched areas should be clearly marked to enable the systematic Search or any follow up action.
- Soak periods should be applied as per theatre



5 Phases to Compound Search

5 Phases:

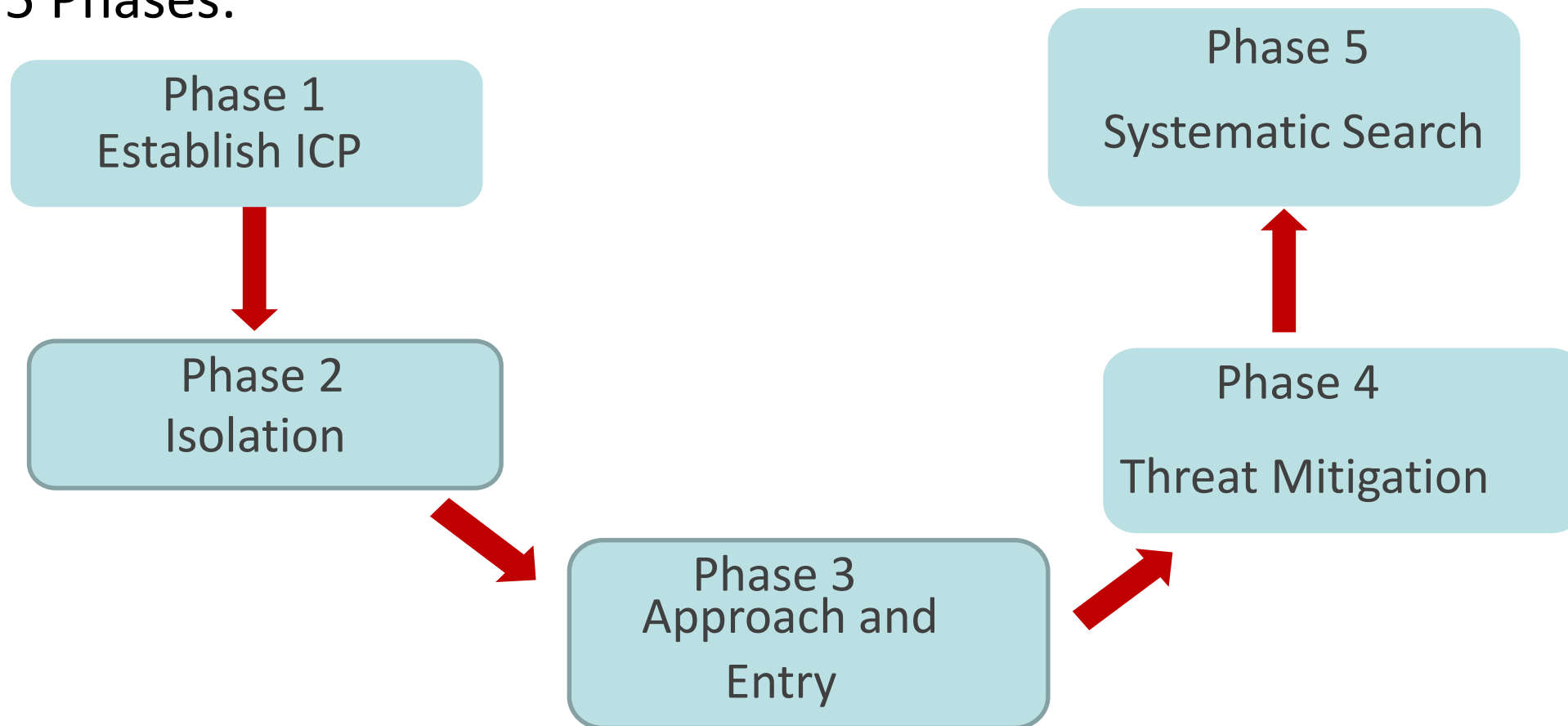



5 Phases to Compound Search

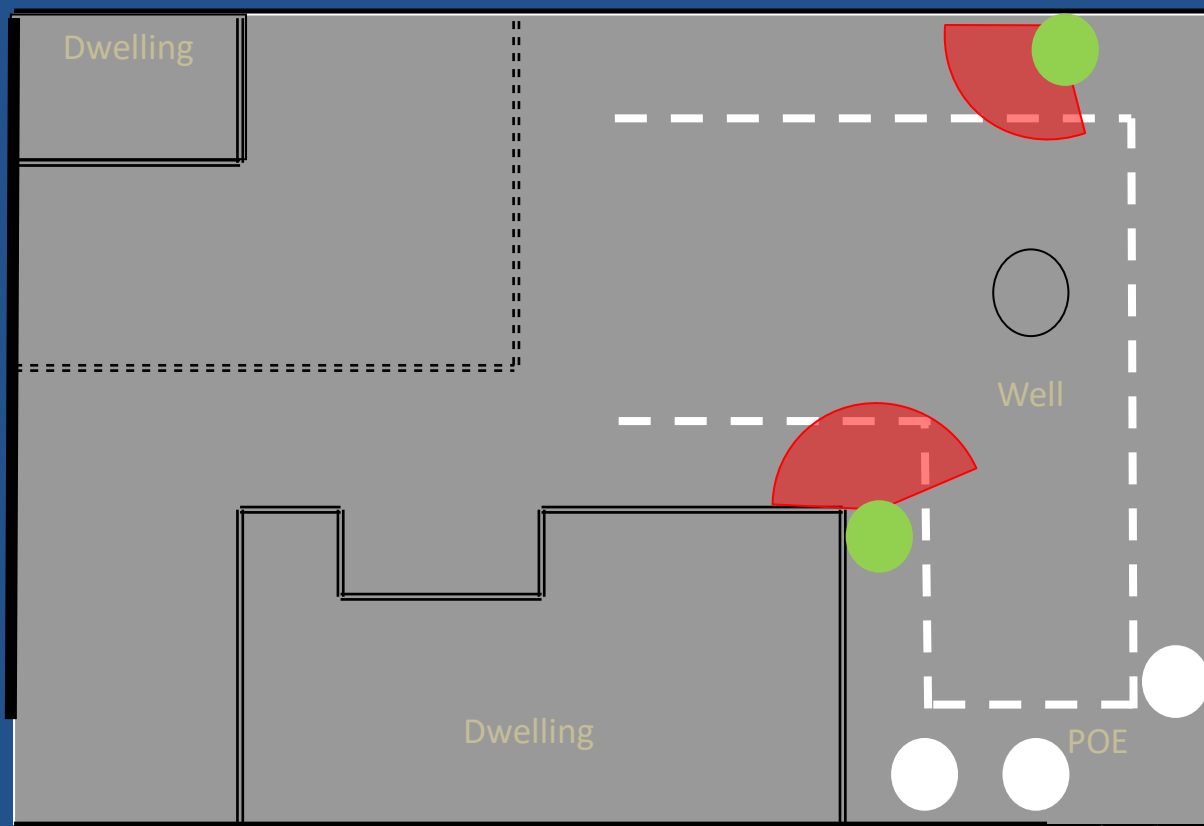

- Handrail wall
- Communication, spacing's
- Mark safe areas, Entry into buildings



P.A.U.S.E

P - Presence of the abnormal

A - Absence of the normal – if it feels dodgy, then it probably is

U - Use equipment

S - Searchers dictate the pace – avoid setting patterns

E - ECM bubble – stay within



Actions on a Find

Finder Inform Team Comd

- **Explosive Find.**
 - *Life Threatening Find.*
 - *Non-Life-Threatening Find.*
- **Non-Explosive Find**
- **Firearms Find**



Actions on a Find

WHAT? A detailed description of what has been found

WHO? Who saw/found it? Any witnesses' other persons in the area at the time?

WHERE? Where it was found, has it been moved? What is the route in and how is it marked?

WHEN? The exact time it was found, How long has it been there?

WHY? Why is it suspicious, why is the search taking place?#

Additional info:

Sketch maps, Knowledge of the local area, Previous incidents in the area, is ECM Available, is anyone remaining within the cordon



5 C,s Cntd....

Confirm – Clear – Call – Cordon – Control





ANY QUESTIONS?



Summary

Compound search can be an extremely complex operation involving a lot of different agencies. Maximum time should be allocated to practice and preparation. Planning must be conducted regarding stringent time constraints to prevent an unnecessary escalation in the situation, potential casualties and loss of initiative.



Look forward to...

MODULE 3.1 – PRACTICAL EXERCISES



ALL ARMS SEARCH COURSE

EXERCISE BOOKLET

2022

SECTION ONE – GENERAL

1. **Introduction.** This booklet contains exercises for the All-Arms Search Course. The booklet will be used by the instructors. The exercises speak more to Learning Outcome 3 on Practical Exercises and Tests.
2. This course has 3 learning outcomes as indicated below:
 - a. **Learning Outcome # 1 – Understanding the operating environment.** Enhance the participants' knowledge of the conventional operating environment, how it is impacted by explosive hazards and develop skills to mitigate the IED threat.
 - b. **Learning Outcome # 2 – Search Operations.** Develop practical skills to conduct the full spectrum of intermediate search capability.
 - c. **Learning Outcome # 3 - Practical Exercises and Tests.** Apply lessons learnt to demonstrate a sufficiently high standard to deploy on operations in an IED threat environment.

List of Acronyms

5Cs	Confirm, Clear, Cordon, Control and Call
AAR	After Action Review
AASC	All Arms Search Course
ADF	Amani Defence Force
ADFPM	Amani Defence Forces Protected Mobility
AJP	Allied Joint Publication
ALF	Amani Liberation Front
AMISOM	Africa Union Mission in Somalia
ANFO	Ammonium Nitrate and Fuel Oil
AO	Area of Operation
AU	Africa Union
AXO	Abandoned Explosive Ordnance
BG	Battle Group
BME	Bomb Making Equipment
BPST-A	British Peace Support Team - Africa
CAGE	Channelling, Aiming Markers, Ground, Environment
CIED	Counter-Improvised Explosive Devices
CMD	Conventional Munition Disposal
CMSA	Colours, Markers, Shapes, and Atmospherics
CRSV	Conflict-Related Sexual Violence
CW	Command Wire
DFC	Directional Fragmentation Charge
ECM	Electronic Countermeasures
EFPs	Explosive Formed Projectiles
EO	Explosive Ordnance
EOD	Explosive Ordnance Disposal
ERW	Explosive Remnants of War
FOB	Forward Operating Base
GSA	Ground Sign Awareness
HHMD	Handheld Metal Detector
HME	Home-made Explosive
I/NGOs	International/Non-Governmental Organizations
ICP	Incidence Command Point
IED TM	IED Threat Mitigation

IED	Improvised Explosive Device
IEDD	Improvised Explosive Device Disposal
LP	Learning Plan
LSA	Land Service Ammunition
MD	Metal Detector
MTT	Mobile Training Teams
MOA	Method of Attack
NATO	North Atlantic Treaty Organization
NCO	Non-Commissioned Officers
NGO	Non-Governmental Organization
NIS	National Intelligence Service
PB	Patrol Base
PCCs	Police Contributing Countries
PSO	Peace Support Operations
PSRD	Peace and Security Research Department
Q&A	Questions and Answers
RC	Remote/Radio Control
ROC	Rehearsal of Concept
RPG	Rocket Propelled Grenade
SBE	Syndicate Based Exercise
SEA	Sexual Exploitation and Abuse
SMEs	Subject Matter Experts
TCCs	Troop Contributing Countries
TM	Threat Mitigation
TTPs	Tactics, Techniques, and Procedures
UAV	Unmanned Aerial Vehicle
UN	United Nations
UNCMD	United Nations Command
UNMAS	United Nation Mine Action Service
UXO	Unexploded Ordnance
VA/VP	Vulnerable Areas/ Vulnerable Point
VB	Vehicle borne
VO	Victim Operated
VOIED	Victim Operated Improvised Explosive Device

BASIC SKILL TESTING – EXERCISE DETAILS

ALL ARMS SEARCH COURSE PRACTICAL EXAMINATION – EBINGER DETECTOR AND CONFIRMATION SKILLS TEST

Objective: To assess the learners’ practical knowledge and competence in operating the detector and confirmation skills.

Conditions: Practical assessment as the MD operator, conducted in a suitable environment.

Equipment required: 1 x detector, 2 batteries, tools, test piece and target, HHMD, paintbrush, red and white markers, pressure plate target.

Time allowed: No time limit.

Learner:	Time & Date:
Location:	Assessor:

Preparation	Yes	No	N/A
Open case & check for completeness& damage to equipment			
Metal-free operator (as much as possible)			
Fit battery correctly			
Insert test stick in the ground in a metal free area			
Operation			
Turn on and select sensitivity range 2 and check battery light is green			
Switch to sensitivity range 3 and hold the detector at the top of the test stick			
Listen for a clear audible signal			
(CRITICAL) if weak or no signal DO NOT use			
Switch to range 1 to begin searching			
Search Procedure			
Detector head kept at a constant distance from the ground			
Ensures no contact between the ground and detector head			
Smooth, constant sweep speed			
Half step method applied			
Confirmation Drill			
‘Maps’ is the source of the alarm. “Stop” the rest of the team. Informs team commander investigation required			
3 markers are placed, left/right and in front, a safe bound away from the alarm			
Replaced Ebinger speaker cap before placing on the ground, request permission to investigate			
Adopts prone position and delineates area with HHMD			
Excavates to a source using correct procedures and equipment			
If a “find” informs the team commander and adopts a safe position			
Marks appropriately pick up equipment and returns to ICP			
Assessors comments:		Pass	RFT

ROUTE SEARCH – EXERCISE DETAILS

EXERCISE OBJECTIVE

This exercise will provide an opportunity for the Search Advisor to conduct a threat assessment with the instructor acting as the Formation Search Coordinator / Sector J2. The Search Advisor after receiving the scenario will have an opportunity to conduct questioning before producing a threat summary and then producing a workable plan with the Team Comd. Collectively, they will deliver a set of Search orders and conduct an ROC drill on a model (produced by the search team whilst the advisor is conducting Threat Assessment).

SITUATION – GENERAL

- (1) You are the Search Adviser in the Amani Defence Force (ADF) based at the Sand Pit, a newly established Patrol Base (PB). The ADF BG Comd has tasked you to conduct a Route search to open new routes to your PB.
- (2) The Sandpit was until a week ago used by Amani Vegetable vendors, who are suspected of being neutral towards the Amani Liberation Front. The Vegetable vendors regularly use the routes around the Sandpit area for pastoral and agricultural activities.
- (3) ALF have an occasional presence in the area moving in and out to conduct attacks on ADF. They aim to disrupt ADF activity and discredit them, seeking to convince the local population that they are the dominant force. They are seeking to win local population support.
- (4) J2 have assessed that there has been a recent arrival of 4-8 insurgents into the AO to coincide with a monthly ADF resupply convoy. The ALF have a small arm and GPMG capability and occasionally carry an RPG. The main threat they pose is from IED attacks. Historically they have used IEDs followed by a shoot and run tactic avoiding an engagement with ADF.

MISSION

You are to CLEAR the route (identified on Map) NLT (1800 on the same day) to enable freedom of movement for the follow-on convoy.

PLANNING INFORMATION

- (1) There have been 2 previous IED strikes that were successful
- (2) You have the following:
- (3) You and your team (IOT search), additional teams may be called forward if justified.
- (4) 1 x Infantry Platoon to act as cordon troop. The remaining Platoons will man the Sandpit PB/QRF.
- (5) IEDD Team at 1 hr response time.
- (6) The instructor will act as all agencies as required. Questions, requests, and points of clarification are to be addressed to the instructor who issued the planning pack.

EXERCISE REQUIREMENTS

As per your mission statement, you are required to:

- a. Brief the instructor on your threat summary and plan (as per the back brief format). This is to include.
 - (i) Threat assessment (in detail) and why / how you came to this assessment.
 - (ii) Plan from start to finish showing breakdown of areas and priorities, likely hide locations VPs, what you expect to find and where.
 - (iii) Agencies required/requested.
 - (iv) Cordon plan and threat to the cordon.
 - (v) Timings.
 - (vi) Actions on find.

ROUTE SEARCH – PARTICIPANTS PRACTICE 1

AIM

This exercise will provide an opportunity for the Search Advisor to conduct a threat assessment with the instructor acting as the Formation Search Coordinator / Sector J2. The Search Advisor after receiving the scenario will have an opportunity to conduct questioning before producing a threat summary and then produce a workable plan with the Team Comd. Collectively, they will deliver a set of Search orders and conduct a ROC drill on a model (produced by the search team whilst the advisor is conducting Threat Assessment).

SITUATION - GENERAL

(1) You are the Search Adviser in the Amani Defence Force (ADF) based at the Sand Pit, a newly established Patrol Base (PB). The ADF BG Comd has tasked you to conduct a Route search to open new routes to your PB.

SITUATION - DETAIL

(2) The Sandpit was until a week ago used by Amani Vegetable vendors, who are suspected of being neutral towards the Amani Liberation Front. The Vegetable vendors regularly use the routes around the Sandpit area for pastoral and agricultural activities.

(3) ALF have an occasional presence in the area moving in and out to conduct attacks on ADF. They aim to disrupt ADF activity and discredit them, seeking to convince the local population that they are the dominant force. They are seeking to win local population support.

(4) J2 have assessed that there has been a recent arrival of 4-8 insurgents into the AO to coincide with a monthly ADF resupply convoy. The ALF have a small arm and GPMG capability and occasionally carry RPG. The main threat they pose is from IED attacks. Historically they have used IEDs followed by a shoot and run tactic avoiding an engagement with ADF.

MISSION

(5) You are to CLEAR the route (identified on Map) NLT (1800 on the same day) to enable freedom of movement for the follow-on convoy.

PLANNING INFORMATION

(6) There have been 2 previous IED strikes that were successful

(7) You have the following:

- a. You and your team (IOT search), additional teams may be called forward if justified.
- b. 1 x Infantry Platoon to act as cordon troop. The remaining Platoons will man the Sandpit PB/QRF.
- c. IEDD Team at 1 hr response time.

(8) The instructor will act as all agencies as required. Questions, requests, and points of clarification are to be addressed to the instructor who issued the planning pack.

REQUIREMENTS

- (9) You are to:
- a. As per your mission statement.
 - b. Brief the instructor on your threat summary and plan (as per the back brief format). This is to include.
 - (i) Threat assessment (in detail) and why / how you came to this assessment.
 - (ii) Plan from start to finish showing breakdown of areas and priorities, likely hide locations VPs, what you expect to find and where.
 - (iii) Agencies required/requested.
 - (iv) Cordon plan and threat to the cordon.
 - (v) Timings.
 - (vi) Actions on find.

Team 1 & 3

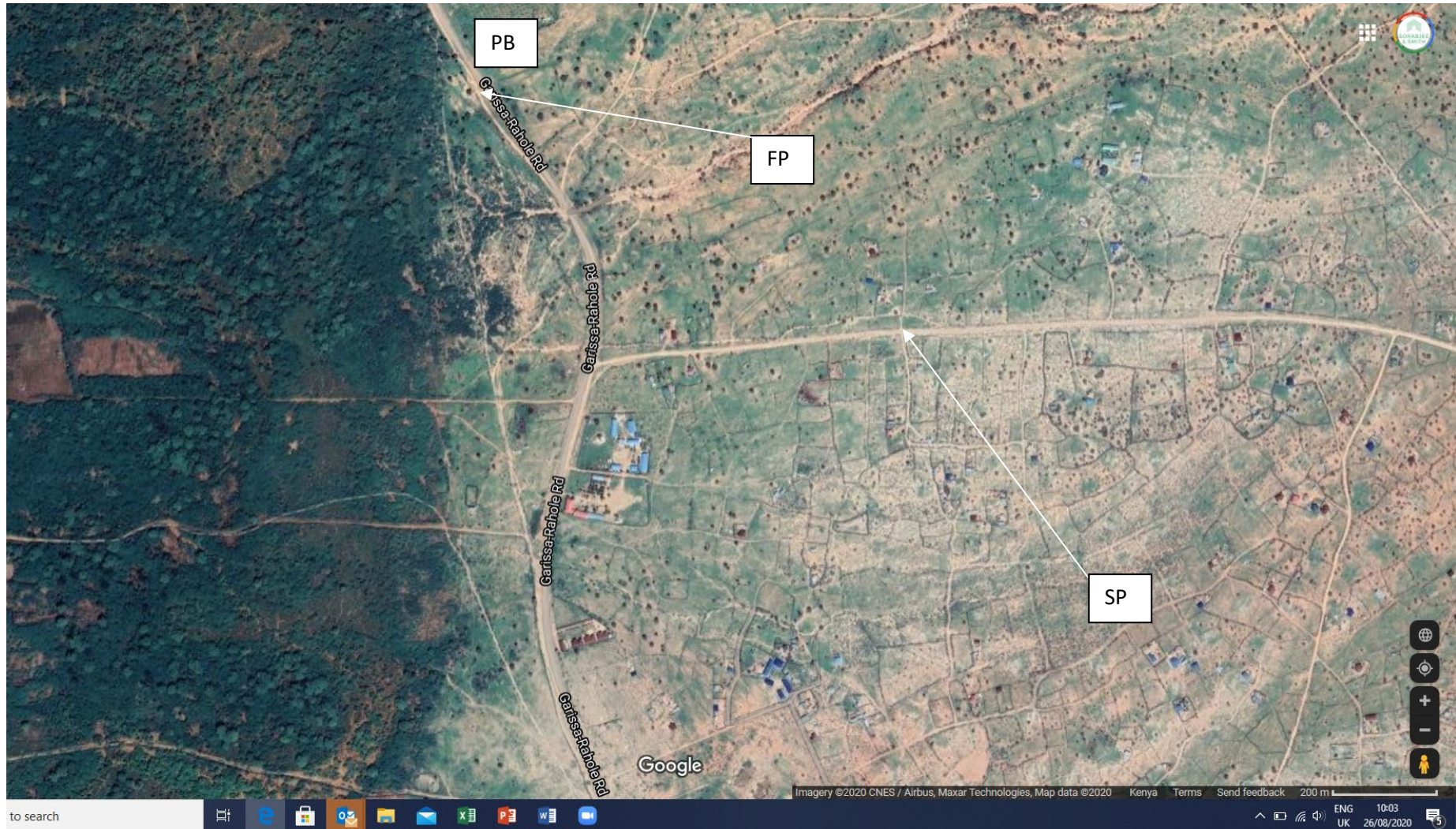

Team 2 & 4



(10) Instructor Guidance for Questions **(not to be issued to students):**

Intent	Capability	Ground
<ul style="list-style-type: none"> a. Kill or maim FF b. Destroy vehicles (Soft skin convoy vehicles, Comd Vehicles prestige weapons) c. Disrupt FF activity d. Discredit FF e. Convince the local population that they are the dominant force f. Win local population support. 	<ul style="list-style-type: none"> a. IEDs with follow on a shoot and run b. AK variants, GPMG, occasional RPG c. Well supplied IED components from UXO or ERW (mainly 105 and 82mm) d. Also, have access to ANFO e. HME usually 10-20kg in blue or black mitungi f. MC is usually in the centre of rad to target the belly of vehicles g. Initiator usually mil or commercial h. RC capability (motorcycle alarm. RX usually remoted to the roadside, TX usually 50-100m) i. CW usually thin twin wires camouflaged using existing linear features. j. Mostly emplaced on slow down points to allow accurate targeting of RC/CW k. Aiming markers are often used 	<ul style="list-style-type: none"> a. Use the map for guidance. b. Locals regularly use these roads (steer students away from VO IED) c. Rural area with mostly pastoral farmers

NB. The instructor is to ensure the remainder of the Search Team also have a copy of the Aerial Photo to allow them to construct a model whilst the Advisor is conducting the threat assessment.

ROUTE SEARCH – PARTICIPANTS PRACTICE 2

AIM

This exercise will provide an opportunity for the Search Team to conduct a full search task. The instructor will act as the Formation Search Coordinator / Sector J2 to allow the Search Advisor to conduct a threat assessment. The Search Advisor after receiving the scenario will have an opportunity to conduct questioning before producing a threat summary and then producing a workable plan with the Team Comd. Collectively, they will deliver a set of Search orders and then search the route.

SITUATION - GENERAL

You are the Search Adviser in the Amani Defence Force (ADF) based at the Sand Pit, a newly established Patrol Base (PB). The ADF BG Comd has tasked you to conduct a Route search to open new routes around the Amani Village.

SITUATION - DETAIL

- (1) The route has been used by ADF in the past and until recently was regularly used by locals who remain neutral towards the Amani Liberation Front.
- (2) ALF have an occasional presence in the area moving in and out to conduct attacks on ADF. They aim to disrupt ADF activity and discredit them, seeking to convince the local population that they are the dominant force. They are seeking to win local population support.
- (3) J2 have assessed that there has been a recent arrival of 4-8 insurgents into the AO to coincide with a monthly ADF resupply convoy. The ALF have a small arm and GPMG capability and occasionally carry an RPG. The main threat they pose is from IED attacks. Historically they have used IEDs followed by a shoot and run tactic avoiding an engagement with ADF.

MISSION

- (4) You are to CLEAR the route (identified on Map) NLT (1800 on the same day) to enable freedom of movement for the follow-on convoy.

PLANNING INFORMATION

- (5) There has not been any use of IED on this road, but there has been IEDs used in the Area of Operation.
- (6) You have the following:
 - a. You and your team (IOT search), additional teams may be called forward if justified.
 - b. 1 x Infantry Platoon to act as cordon troop. The remaining Platoons will man the Sandpit PB/QRF.
 - c. IEDD Team at 1 hr response time.
- (7) The instructor will act as all agencies as required. Questions, requests, and points of clarification are to be addressed to the instructor who issued the planning pack.

REQUIREMENTS

- (8) As per your mission statement, you are to:
- a. Brief the instructor on your threat summary and plan (as per the back brief format). This is to include.
 - (i) Threat assessment (in detail) and why / how you came to this assessment.
 - (ii) Plan from start to finish showing breakdown of areas and priorities, likely hide locations VPs, what you expect to find and where.
 - (iii) Agencies required/requested.
 - (iv) Cordon plan and threat to the cordon.
 - (v) Timings.
 - (vi) Actions on find.



(9) Instructor Guidance for Questions **(not to be issued to students):**

Intent	Capability	Ground
<ul style="list-style-type: none"> a. Kill or maim FF b. Destroy vehicles (Soft skin convoy vehicles, Comd Vehicles prestige weapons) c. Disrupt FF activity d. Discredit FF e. Convince the local population that they are the dominant force f. Win local population support. 	<ul style="list-style-type: none"> a. IEDs with follow on a shoot and run b. AK variants, GPMG, occasional RPG c. Well supplied IED components from UXO or ERW (mainly 105 and 82mm) d. Also, have access to ANFO e. HME usually 5-10kg in blue or black mitungi f. MC is usually in the centre of the road to target the belly of vehicles g. Initiator usually mil or commercial h. No RC has been recorded in the area. i. CW usually thin twin wires camouflaged using existing linear features. j. Mostly emplaced on slow down points to allow accurate targeting of RC/CW k. Aiming markers are often used 	<ul style="list-style-type: none"> a. Use the map for guidance. b. Locals have stopped using these roads (steer student towards VO threat) c. Rural area with mostly pastoral farmers

NB. Instructor is to ensure remainder of the Search Team also have a copy of the Aerial Photo to allow them to construct a model whilst the Advisor is conducting the threat assessment.

ROUTE SEARCH – PARTICIPANTS TEST 1 & 2

AIM

This exercise will be the test scenario for the assessment of the Search Advisor and the Search Team. The Search Advisor will be required to conduct a threat assessment, followed by the delivery of orders including a threat summary. The team will be required to conduct ROC drills and deploy to the area to complete a search under test conditions.

SITUATION - GENERAL

(1) You are the Search Adviser based at Humanitarian Peace Support School (HPSS). As the search Advisor for the Amani Defence Forces (ADF) you have been given the following information:

SITUATION - DETAIL

(2) Due to recent Amani Liberation Front (ALF) activity in the AO, the ADF wish to establish a short new term Patrol Base (PB) further into ALF territory. They have identified several suitable locations, IOT reaches this location the route to it must be searched.

(3) The Area is on the rural-urban interface of the town of Embakasi, an ALF stronghold. The routes in this area were frequently used by pastoral farmers, who are sympathetic to the ALF, until 1 week ago when activity stopped. This coincided with planning for the operation. J2 believes that there are informants who have warned the ALF of the planned move north by ADF.

(4) ALF have a strong presence in the area and often employ locals to do their activity (move weapons and emplace IEDS). As is one of the few forms of income in the area it is well supported. They aim to disrupt ADF activity and discredit them, seeking to maintain the local population support. The ALF have approx. a PI+ in the area. They are well-armed, but their most likely MOA remains IEDs. Recent large finds of UXO in the area have reduced the availability of these assets for making IEDs and so the ALF more commonly employ ANFO for their MC. Recent improvement in ADF vehicles means smaller HME MC is no longer effective, so the insurgent is moving to larger MCs

MISSION

(5) You are to conduct a threat assessment for your route and subsequently plan and conduct a Route Search (as identified).

PLANNING INFORMATION

(6) The route identified has been transited recently by joint recce teams in both Amani Defence Forces Protected Mobility (ADFPM) and Amani Police Service vehicles.

(7) You have the following:

- a. 1 Search Team. No other teams are available to you.
- b. 1 x Infantry Coy to act as cordon troops.
- c. Recent imagery.
- d. 1 x IEDD team on call and will remain in the SSP with the other convoy vehicles.

(8) The instructor will act as all agencies as required. Questions, requests, and points of clarification are to be addressed to the instructor who issued the planning pack.

REQUIREMENTS

- (9) As per your mission statement, you are to:
- a. Brief the instructor on your threat assessment and plan (as per the back brief format). This is to include.
 - (i) Threat assessment (in detail) and why / how you came to this assessment.
 - (ii) Plan from start to finish showing the start and finish of the route, insertion point (and method), SSP, ICP, isolation routes, crossovers, VPs, what you expect to find and where.
 - (iii) Agencies required/requested.
 - (iv) Cordon plan and threat to the cordon.
 - (v) Timings.
 - (vi) Actions on find.



FP

SP



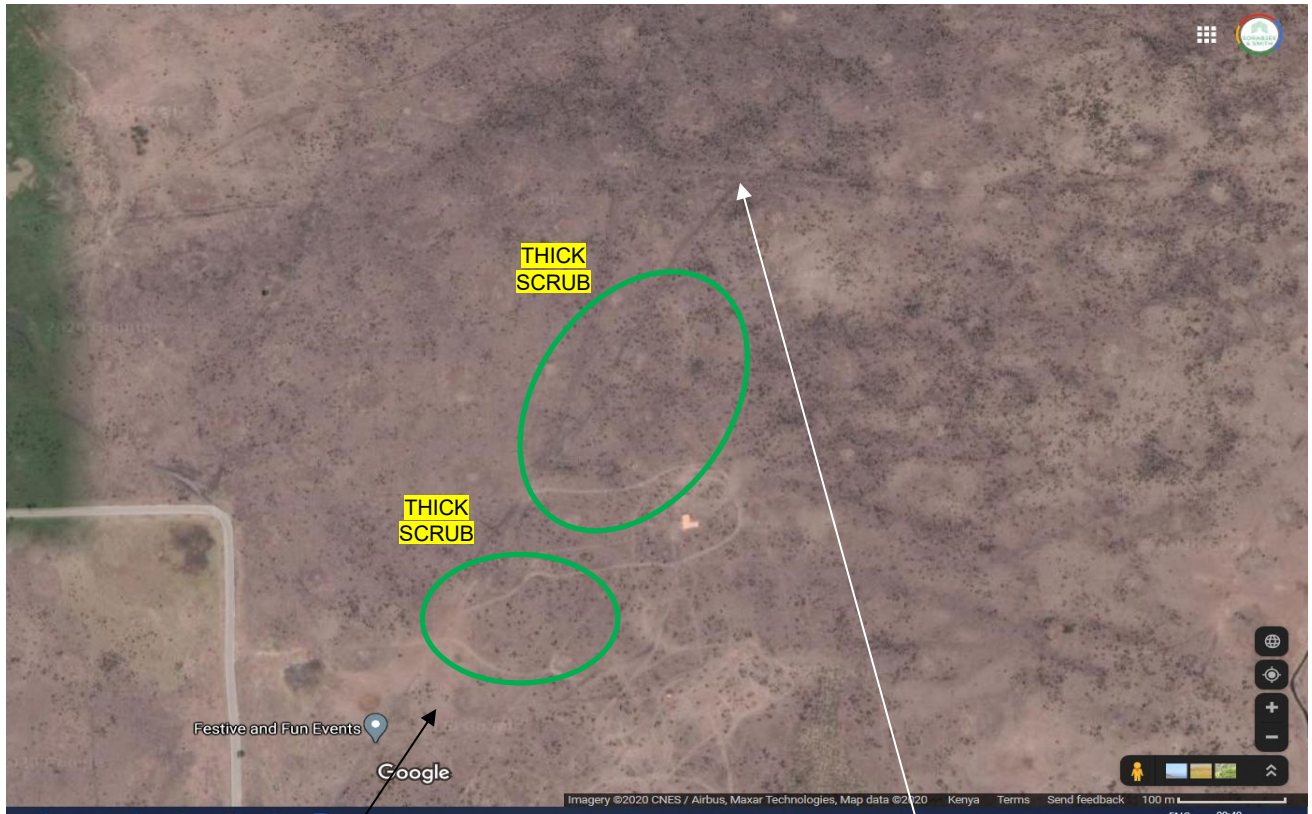

SP

FP



(10) Instructor Guidance for Questions **(not to be issued to the students):**

Intent	Capability	Ground
<ul style="list-style-type: none"> a. Kill or maim FF b. Destroy vehicles (Soft skin convoy vehicles, Comd Vehicles prestige weapons) c. Disrupt FF activity d. Discredit FF e. Maintain local population support. 	<ul style="list-style-type: none"> a. IEDs with follow on a shoot and run b. AK variants, GPMG, occasional RPG c. Well supplied IED but limited UXO and ERW following previous operations so mainly employing ANFO. d. HME usually 15-20kg in blue or black mitungi e. MC is usually in the centre of the road to target the belly of vehicles f. Initiator usually mil or commercial g. RC capability (motorcycle alarm. RX usually remoted to the roadside, TX usually 50-100m) h. CW usually thin twin wires camouflaged using existing linear features. i. VO usually uses improvised pressure plates (usually two wooden planks with Hacksaw Blades) j. PP are usually in the wheel ruts, but batteries are remoted to the side of the road to avoid detection. k. Markers are often used to warn locals. 	<ul style="list-style-type: none"> a. Use the map for guidance. b. Locals regularly use these roads, but activity has recently stopped (steer student away from CW IED) c. There are some channelled areas on the route

AREA SEARCH – EXERCISE DETAILS

AREA SEARCH – PRACTICE 1

Time: 4 x45 Mins Periods

Objective

To practice the participants understanding of the process and mechanics of an area search task.

Guidance

The instructors are to select several areas to search. This will be dependent on the number of teams on the course. In each area, the instructor is to conceal a suitably sized item. The teams are to be issued the following scenario:

“Intelligence suggests that the ADF are storing Bomb Making Equipment (BME) near the Amani village. This equipment is being stored in transit to allow it to be later assembled and used against friendly forces. You are to search the identified area for BME. You will be operating as an independent team as other teams are searching for alternative locations”

AREA SEARCH TEST 1

Time: 4 x 45 Mins Periods

Objective

To test the participants understanding of the process and mechanics of an area search task.

Guidance

The instructors are to select a suitable area to search. This will be dependent on the number of teams on the course. In each area, the instructor is to conceal a suitably sized item. The teams are to be issued the following scenario:

“Intelligence suggests that the ADF are storing Bomb Making Equipment (BME) near the Amani village. This equipment is being stored in transit to allow it to be later assembled and used against friendly forces. You are to search the identified area for BME. You will be operating as an independent team as other teams are searching for alternative locations”

NB: Instructors are to ensure the Teams conduct test tasks in alternative areas to where they conducted practice.

COMPOUND SEARCH – EXERCISE DETAILS

COMPOUND SEARCH PRACTICE 1

Time: 4x45 Mins Periods

Objective

To practice the participants understanding of the process and mechanics of a compound search task.

Guidance

The instructors are to allow the teams to individually conduct a compound search. The teams will each search for sequence. The teams are to be issued the following scenario:

“Intelligence suggests that the ADF have been using the compound to rest and manufacture IEDs. Friendly forces plan to take over and occupy the compound to deny the ADF use of it. However, it is suspected that the compound may be protected with IEDs. You are to search and clear the compound. You will be operating as an independent team as other teams are searching for alternative locations”

All Arms Search Course Handout



NOTES

Introduction to Route Search

Key Points	Notes
<p>Definition of Search</p> <p>The capability to locate specified targets using intelligence assessments, systematic procedures, and appropriate detection techniques</p>	

Key Points	Notes
<p>Six Component Parts of an Improvised Explosive Device (IED) - PIECES</p> <p>1. Component Parts:</p> <p>a. P – Power Source:</p> <ul style="list-style-type: none"> (1) 9v – P3 Square (2) 12v Motorcycle Batt <p>b. I - Initiators Detonator:</p> <ul style="list-style-type: none"> (1) Military (2) Commercial (3) Improvised <p>c. E - Explosive – MC/Energetic Material</p> <ul style="list-style-type: none"> (1) Explosive content: <ul style="list-style-type: none"> (a) Military (Harvested) (b) Commercial (b) Improvised HME (2) Charge effect: 	<p>ERW-UXO - AXO</p> <p>Aluminium Powder/Paste/Fertiliser Ammonium Nitrate (29%) /UREA</p>

- (a) Blast
- (b) Fragmentation
- (C) Shaped charge – EFP/DFC/Platter Charge
- (d) Combination

d. C – Container:

- (1) Ease of transportation
- (2) Aid concealment
- (3) Weatherproofing
- (4) May enhance charge effect

e. E - Enhancements:

- (1) Resin – Nuts and bolts – Shipyard confetti
- (2) Nails – Ball (steel) Bearings

f. S – Switch:

- (1) **Time Delay (TD) Setting Patterns!**
 - (a) Short delay – mechanical rundown timers
 - (b) Long Delay – electrical timers
- (2) **Command Initiated:**
 - (a) **Command Wire (CWIED)**
 - (b) **Radio Controlled (RCIED)**
 - (c) **Suicide (PBIED, SVBIED)**
- (3) **Victim Operated (VO):**
 - (a) **Pressure (PPIED)**
 - (b) Pull/Trip
 - (c) Pressure Release

Not essential but nice to have to enhance the fragmentation effect.

PATTERN SETTING!!!!

Key Points	Notes
<p data-bbox="204 315 608 349"><u>Ground Sign Awareness - GSA</u></p> <p data-bbox="204 394 440 427">Definition of Sign</p> <p data-bbox="204 472 995 544">1. Any change from the natural state that is inflicted on the environment by the passage of man, animal, or machinery.</p> <p data-bbox="204 589 504 622">Characteristics of Sign</p> <p data-bbox="204 667 400 701">1. Regularity:</p> <p data-bbox="248 745 794 779">a. Shapes, not normally found in nature:</p> <p data-bbox="293 824 523 857">(1) Straight lines</p> <p data-bbox="293 902 587 936">(2) Geometric shapes</p> <p data-bbox="204 981 400 1014">2. Flattening:</p> <p data-bbox="248 1059 900 1131">a. The general levelling/depression, identified by comparison of the immediate surrounding area</p> <p data-bbox="204 1176 376 1209">3. Transfer:</p> <p data-bbox="248 1254 944 1326">a. The transit of materials from one environment to another:</p> <p data-bbox="293 1370 488 1404">(1) Mud/sand</p> <p data-bbox="293 1449 520 1482">(2) Grass/leaves</p> <p data-bbox="293 1527 443 1561">(3) Water</p> <p data-bbox="204 1606 456 1639">4. Colour change:</p> <p data-bbox="204 1684 874 1756">a. The difference in colour or texture from the surrounding area.</p> <p data-bbox="204 1800 411 1834">5. Discardable</p> <p data-bbox="248 1879 906 1951">a. Items that can be confirmed/attributed to the enemy.</p> <p data-bbox="204 1995 416 2029">6. Disturbance</p>	

<p>a. Any evidence of change or rearrangement of the natural state caused by the passage of the target.</p>	
---	--

Key Points	Notes
<p>Vulnerable Points – Vulnerable Area (GAGE)</p> <p>Ground.</p> <p>Identify any Vulnerable Points and Vulnerable Areas (VPs/Vas) along the route. The following factors should be considered:</p> <ol style="list-style-type: none"> 1. C - Channelled: Does the ground channel movement? <ol style="list-style-type: none"> a. River Crossings – Bridges – Culverts – fixed into a position 2. A - Aiming Markers: Are there any aiming markers (natural or artificial) for Command IED: <ol style="list-style-type: none"> a. Natural – Isolated Trees b. Man-Made – Telegraph Poles <ol style="list-style-type: none"> (1) Warning Markers – AS/Local (2) Pyramid - Stones (3) Cloth - Material on Trees 3. G - Ground: Other ground features such as linear features, high ground FP, slow down points, Line of sight, access egress 4. E - Environment: Remember – Absence of the normal Presence of the abnormal – Atmospherics!! 	

Key Points	Notes
<p>Search Procedures</p> <p>The procedures employed will be dictated by the Threat Assessment and Route Analysis. The procedures employed can be adapted to suit the terrain and assessed threat, most search operations are likely to incorporate several different Procedures and can include the following:</p> <ol style="list-style-type: none"> 1. VP 360 Domination <ol style="list-style-type: none"> a. Used to search individual assessed VPs or VAs 2. Single Team Route Search. <ol style="list-style-type: none"> a. Used to search several VPs or VAs nearby or in a HIGH CWIED Threat Environment (Cross over before/after VP) 3. Two Team Rolling Route Search. <ol style="list-style-type: none"> a. Used to Search longer stretches of the route, the isolation and Road Party search is concurrent. 4. Stop Short Point – 5m & 25m Check (Halt procedure). <ol style="list-style-type: none"> a. Four Phase Operation. All dismounted Route Search Operations begin at Stop Short Point (SSP/Halt Procedure - 5M&25M). <p>Phase One. The SSP is searched using the 5M&25m Search Procedure. The basic principles are as follow:</p> <ol style="list-style-type: none"> (a) UNMAS (b) Unpredictable – stop in an unpredictable location. (c) No Concealment – select an area with minimum concealment for an IED. (d) Maintain Over-Watch – Top gunners remain in position to provide security. (e) Alert – remain alert for ground sign and IED Indicators. (f) Spacing – remain dispersed (25m per vehicle/10m per person) 	<p>DOMINATION TROOPS DEPLOYED ON FLANKS ONE BOUND IN FRONT HIGH GROUND/LINE OF SIGHT TO VP/POSS CONCEALED FP's/GOOD ACCESS AND EGRESS (ESCAPE ROUTES) POSS MARKERS.</p>
<p style="text-align: center;">Key Points</p>	<p style="text-align: center;">Notes</p>
<p>Phase One – Stop Short Point (SSP) - 5M&25M</p>	

The SSP is searched using the 5M&25m Halt Procedure. The basic principles are as follow using **UNMAS**:

- (a) **UNMAS**
- (b) **Unpredictable** – stop in an unpredictable location.
- (c) **No Concealment** – select an area with minimum concealment for an IED.
- (d) **Maintain Over-Watch** – Top gunners remain in the position to provide security.
- (e) **Alert** – remain alert for ground sign and IED Indicators
- (f) **Spacing** – remain dispersed (**25m per vehicle/10m per person**)

Figure 1: Start positions for 5M & 25m Check.

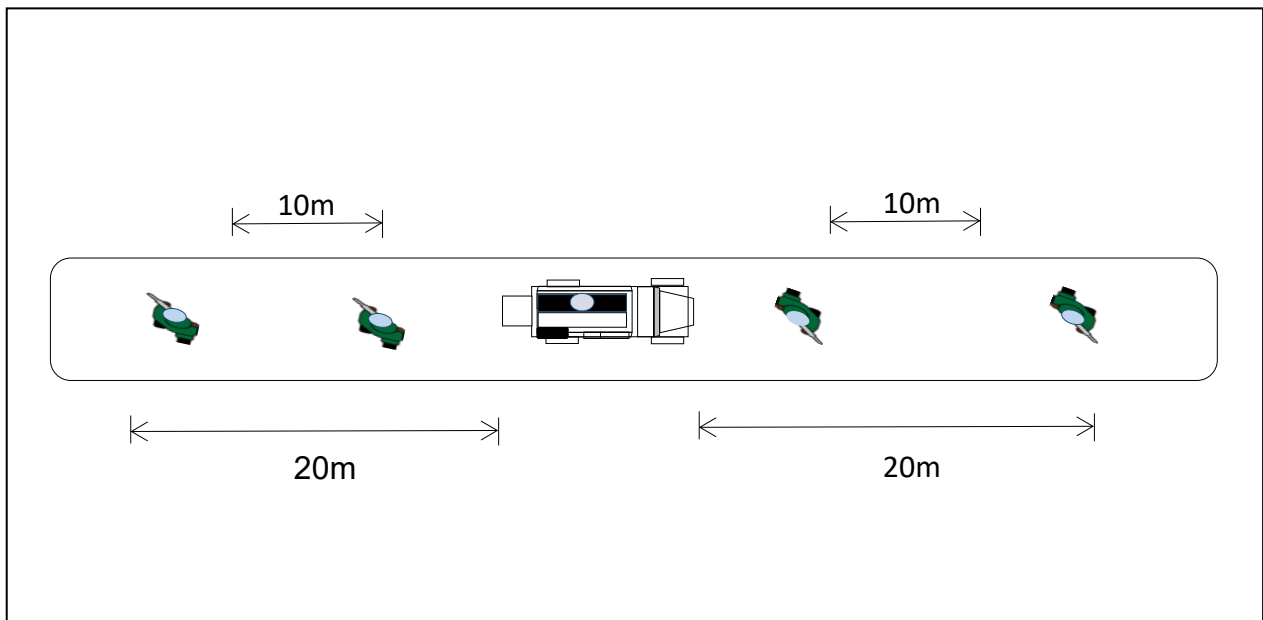
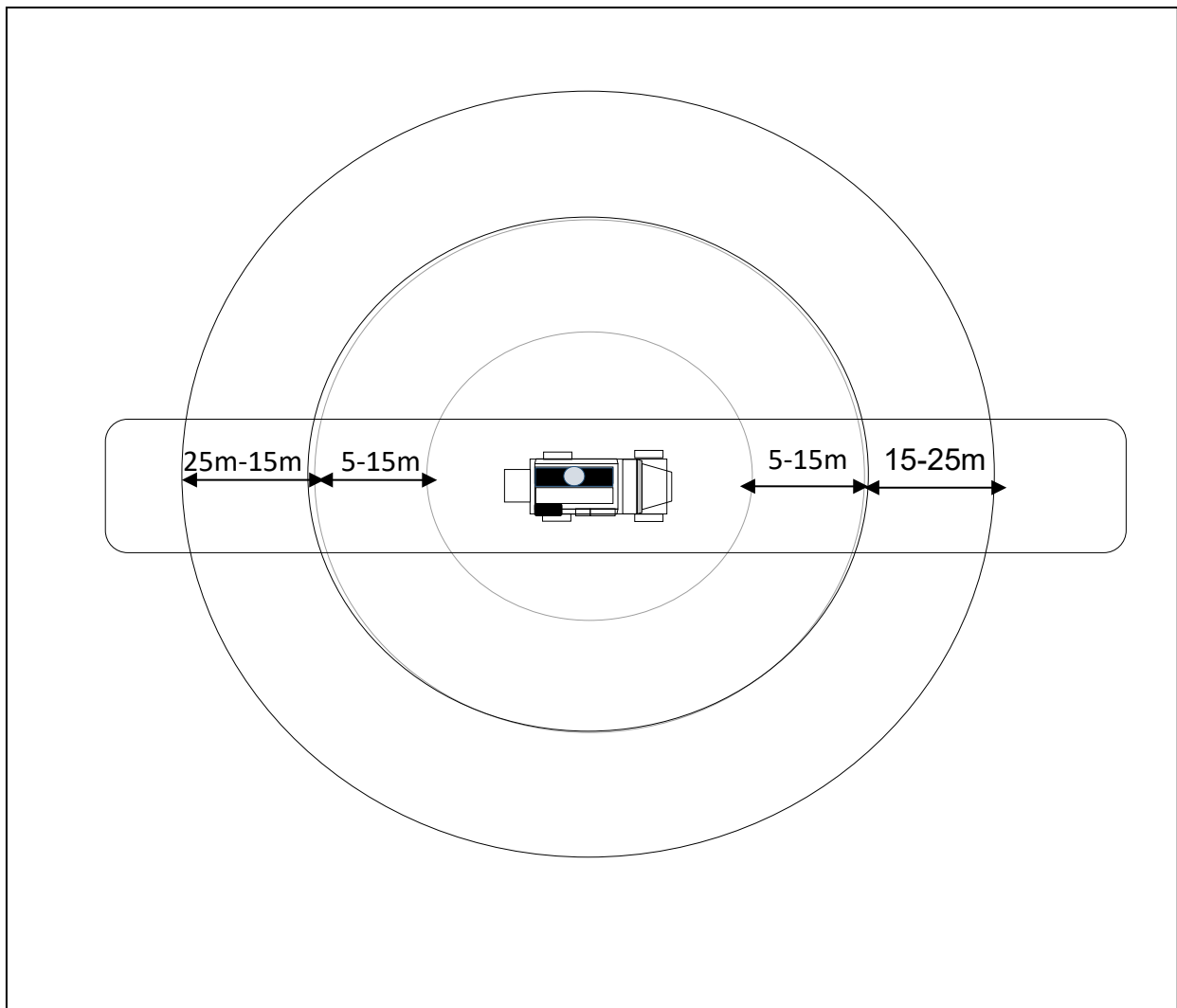

Figure 2: Areas of responsibility during 25m Check



Key Points	Notes
Phase Two - DOMINATION	
<p>DOMINATION troops are deployed on each flank (Half Bound Forward (Mounted/Dismounted terrain dictated) to dominate high ground which could be potential AS firing Points (FP) where Trigger men could be located (High Ground/Good Cam and Concealment/Line of Sight onto the Contact Point (CP)/Good Escape Routes)</p>	<p>Implied Tasks for the DOMINATION Troops they must understand what Actions On to be conducted if they find/locate a Command Wire.</p>

Key Points	Notes
Phase Three – Isolation of the VP	
<p>Isolation VPs/VAs are isolated to locate any Command Wires (CWIEDS) that are surface laid, buried or concealed along linear features (Walls/Water Features/Fences etc) running parallel (MSR) or into the VP. It is conducted by deploying an Isolation Team/s. The routes should be unpredictable, and distances varied to avoid setting patterns. The configuration of an Isolation Team is shown below.</p>	<p>If at any stage the Isolation Path Finder feels he is being channelled or has identified an IED indicator, then he must increase his personnel Threat Assessment and use the Detector accordingly.</p>

Figure 3 – Isolation Team Configuration

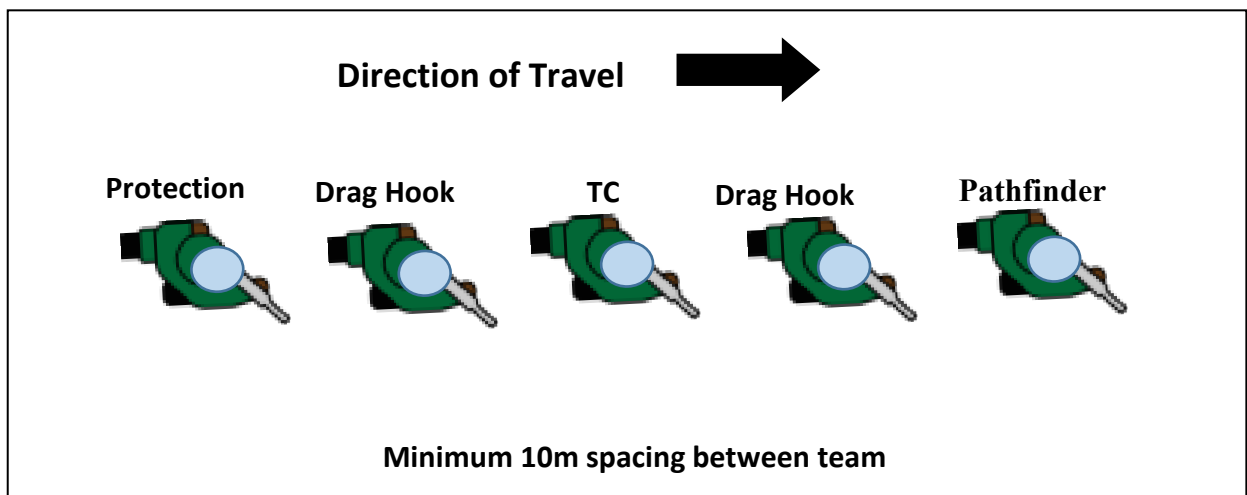

Key Points	Notes
Isolation of the VP	
<p>Isolation: Individual VPs can be isolated by deploying a single Isolation Team from the SSP to conduct a 360-degree circuit of the VP at an assessed safe distance (min 50m). The Isolation party deploy from the rear of the SSP and Isolate the threat side first.</p>	

Figure 4 – VP Isolation Route

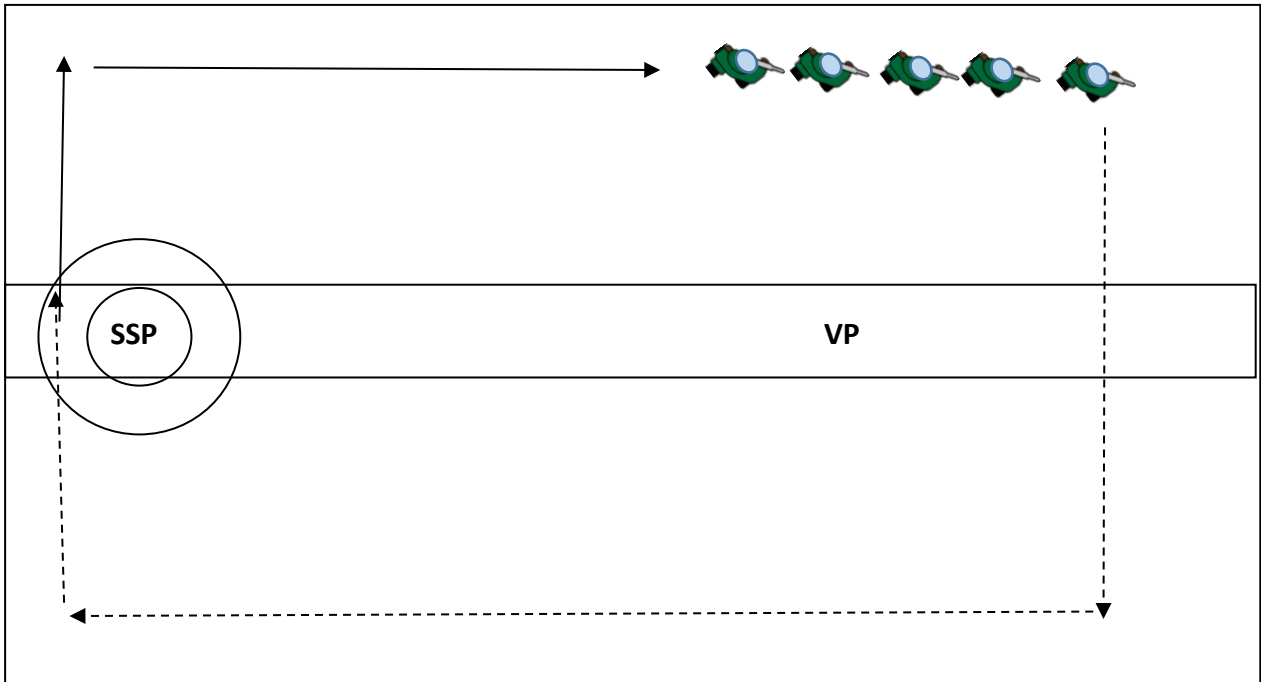

Key Points
Phase Four – Road Party
Road Party. The Road Party is formed (Team Commander and Four Searchers) and a systematic search of the route is conducted through the VP to the cross over markers (end of Route Procedure). The width of the route to be searched will be determined by the widest vehicle on the convoy (room for dismounts).

Key Points
Single Team Route Search
Single Team Route Search (High CW Threat Environment – Flat Fig 8). Four Phase Operation (as per VP 360 Domination). When conducting a Single Team Route Search (multiple VPs in proximity/ High CWIED Threat) the Isolation Team deploys from the SSP and conduct a Figure 8 Isolation of any assessed VPs as shown in Figure 5.

Figure 5 – Single Team Isolation

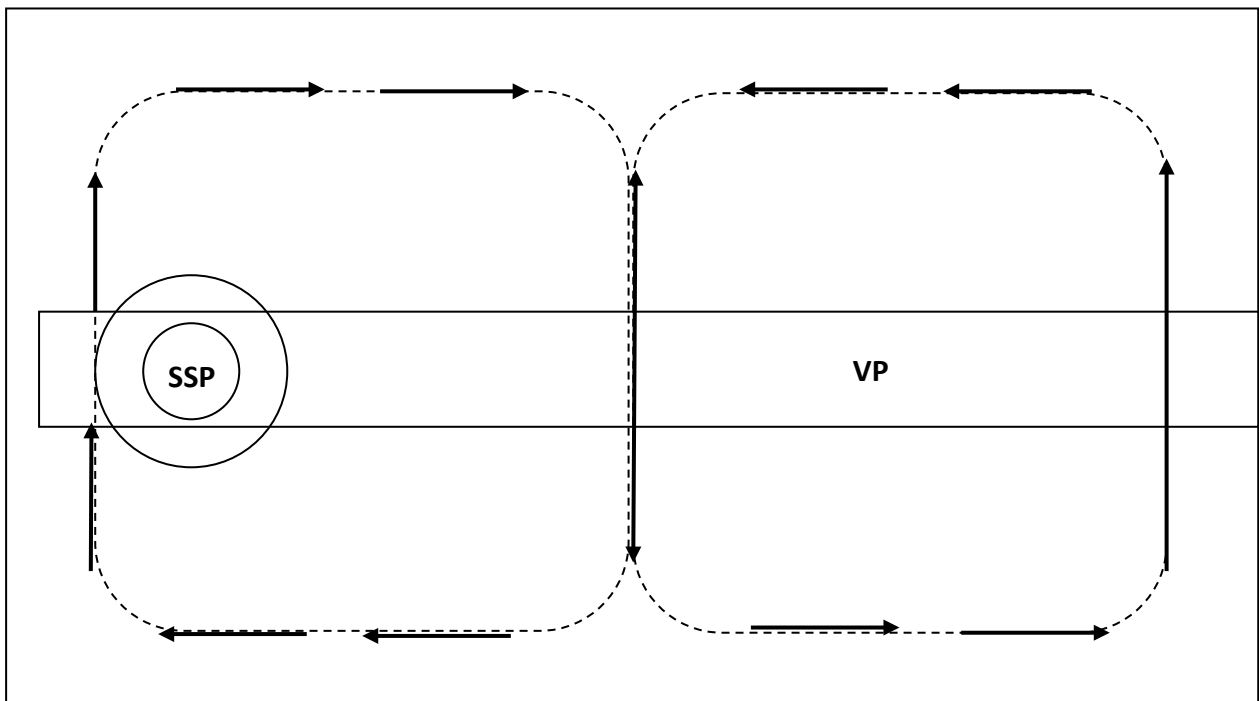

Key Points
Two Team Rolling Route Team Route Search
<p>1. Two Team Rolling Route Search Isolation</p> <p>Four Phase Operation. Isolation during a Rolling Route Search is conducted by two Isolation Teams (Second Tm split – Infantry escorts) operating on each flank of the route. The teams deploy from the SSP and isolate in a series of bounds at the end of each bound a “crossover” is completed by one of the teams. The Isolation and Route search are concurrently enabling a longer length of the route to be searched more quickly than during Single Team Operations.</p> <p>GOLDEN RULE - A minimum of Two crossovers must be maintained between Road Team and Isolation Teams (Fig 6)</p>

Figure Six – Rolling Route Search

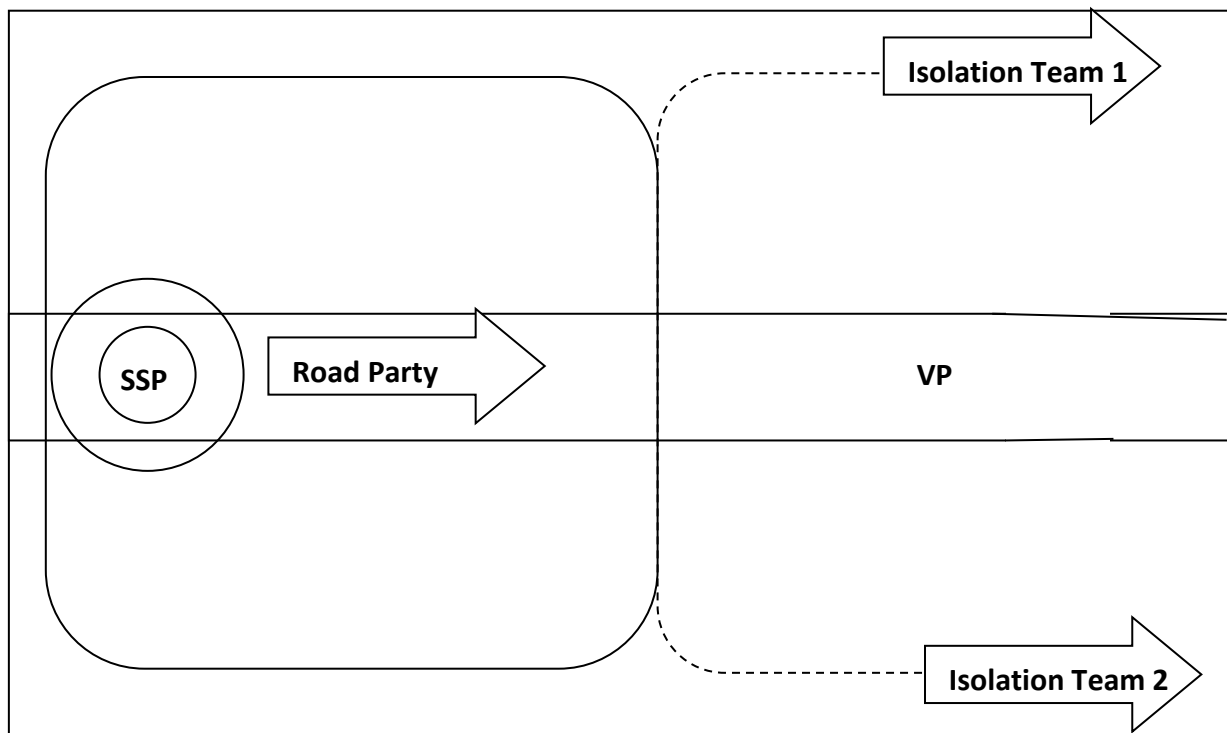

Key Points
<p>Phase 4 Two Team - Road Party</p> <p>Systematic Search of the Route. Once Isolation is complete the route is systematically searched by a Road Team. The Road Team are responsible for ensuring that the entire trafficable width of the route has been searched using detection equipment Ebinger SC100UN). The exact configuration of the Road Team can be adapted but the standard configuration is shown in Figure 7. A min of 10m spaces between each member of the road party must adhere to. The vehicle will follow 10m behind the Team Commander.</p> <p>Within the Road Team, both the all-road party searches (two Outer Road Men (ORM) and Inner Road Men) are to be equipped with a detector/magnetometer. If the entire trafficable width of the route can't be covered effectively by the two ORM then the Search Commander should consider re-configuring the Road Team to ensure the full trafficable width is searched.</p>

Figure 7 – Standard Road Party Configuration

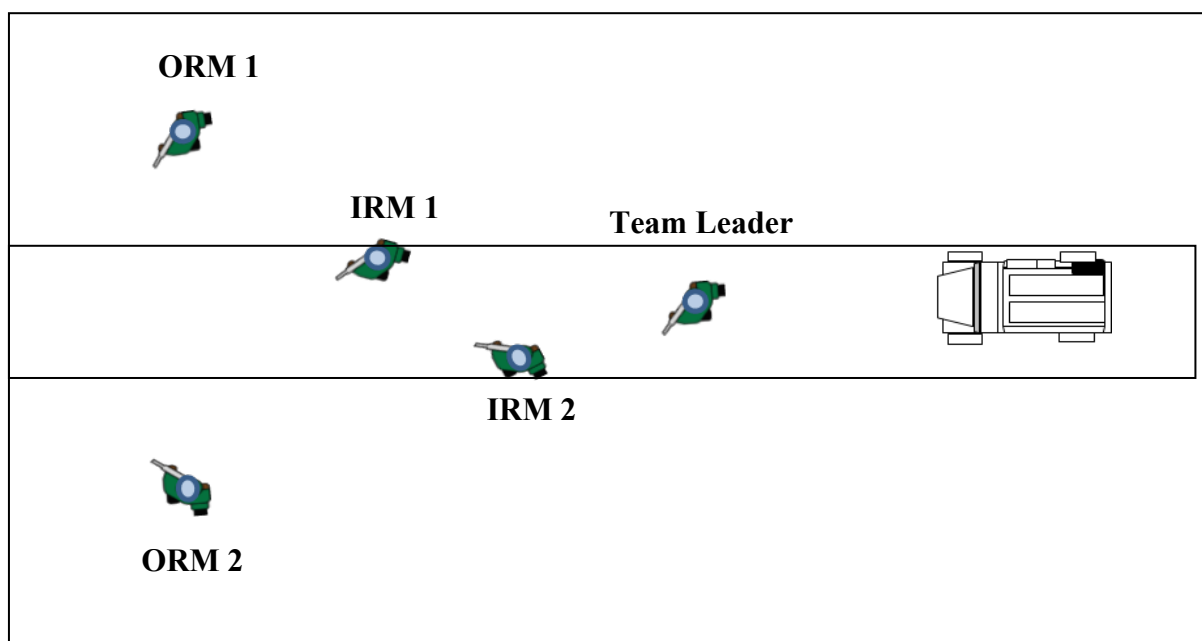

Key Points
<p>Actions On</p> <p>Actions On</p> <p>If a suspected IED is located and confirmed during the Search Operation the priority is to extract the Search Team (Once marked). Then a 5C's Operation is conducted. The finder should then be separated and given time to sketch the Ground in general/detail of the device location (IED Indicators, marking system used, GSA at a location, Aiming Markers/Areas of ground that might hinder the EOD/IEDD Operator approach (Wet, slopes, restrictions etc)</p>

Abbreviations

- IED = Improvised Explosive Device
- RCIED = Radio Control IED
- PPIED = Pressure Plate IED
- CWIED = Command Wire IED
- VOIED = Victim Operated IED
- CIED = Command IED
- SVBIED = Suicide Vehicle Bourne IED
- UVIED = Under Vehicle IED
- VBIED = Vehicle Bourne IED
- PBIED = Person Borne IED
- ERW = Explosive Remnants of war
- EOD = Explosive Ordnance Disposal
- UXO = Unexploded Ordnance
- AXO = Abandoned Explosive Ordnance
- RSIED = Roadside (MSR Emplacement) IED
- SCS = South Central Somalia
- MILEX = Military Explosive
- AMISOM = AU Mission in Somalia
- ERW = Explosive Remnants of War
- MILORD = Military Ordinance
- SPF = Somali Police Force
- HE = High Explosive(s)
- PIECES = Power Source, Initiator, Energetic material, Container, Enhancement(s) & Switch(es)